











THE  
APPLIED ANATOMY  
OF THE  
NERVOUS SYSTEM,

*BEING A STUDY OF THIS PORTION OF THE HUMAN BODY  
FROM A STANDPOINT OF ITS GENERAL INTEREST AND  
PRACTICAL UTILITY, DESIGNED FOR USE AS A  
TEXT-BOOK AND A WORK OF REFERENCE.*

BY

AMBROSE L. RANNEY, A. M., M. D.,

ADJUNCT PROFESSOR OF ANATOMY AND LATE LECTURER ON THE DISEASES OF THE GENITO-URINARY  
ORGANS AND ON MINOR SURGERY IN THE MEDICAL DEPARTMENT OF THE UNIVERSITY OF  
THE CITY OF NEW YORK; LATE SURGEON TO THE NORTHERN AND NORTHWESTERN  
DISPENSARIES; RESIDENT FELLOW OF THE NEW YORK ACADEMY OF MEDI-  
CINE; MEMBER OF THE MEDICAL SOCIETY OF THE COUNTY OF NEW  
YORK; AUTHOR OF A "PRACTICAL TREATISE ON SURGICAL  
DIAGNOSIS," "THE ESSENTIALS OF ANATOMY," ETC.

*WITH NUMEROUS ILLUSTRATIONS.*

"The greatest thing a human soul ever does in this world is to see something, and tell what he saw in a plain way. Hundreds of people can talk for one that can think, but thousands can think for one who can see. To see clearly is poetry, prophecy, and religion all in one."—JOHN RUSKIN.

NEW YORK:  
D. APPLETON AND COMPANY,  
1, 3, AND 5 BOND STREET.  
1881.

COPYRIGHT BY  
D. APPLETON AND COMPANY,  
1881.



TO  
THE FACULTY  
OF THE MEDICAL DEPARTMENT  
OF THE  
UNIVERSITY OF THE CITY OF NEW YORK,  
UNDER THE GUIDANCE OF SOME OF WHOM  
I PURSUED MY EARLY MEDICAL STUDIES,  
AND TO WHOSE INDUSTRY AND TALENT  
IS DUE MUCH OF THE SUCCESS  
WHICH HAS CROWNED THEIR EFFORTS AS INSTRUCTORS,  
THIS VOLUME  
IS RESPECTFULLY DEDICATED  
BY THE AUTHOR.



## P R E F A C E

---

THIS volume comprises a course of lectures which were delivered by me before the students of the Medical Department of the University of the City of New York during the winter of 1880 and 1881. They are presented to the reading public, with few alterations, as they were originally reported for some of the medical journals, and for the private use of the author. The same colloquial style in which they were delivered has been retained, since it is believed that it will thus better fill the requirements of a text-book. I am well aware that the highest type of literary composition is not of this conversational character, and that it may be to some readers a drawback rather than an attractive feature in the volume; but the fact is also recognized that the best style, theoretically, is not always the clearest and the most forcible, and that successful teachers have often to sacrifice beauty of rhetoric in order to impart their knowledge.

I have departed somewhat from the custom of anatomical authors in making diagrammatic illustrations—which it is my habit to draw upon the black-board before my classes, in order to make the listener use the eye as well as the intelligence as a means of gaining information—a prom-



## P R E F A C E

---

THIS volume comprises a course of lectures which were delivered by me before the students of the Medical Department of the University of the City of New York during the winter of 1880 and 1881. They are presented to the reading public, with few alterations, as they were originally reported for some of the medical journals, and for the private use of the author. The same colloquial style in which they were delivered has been retained, since it is believed that it will thus better fill the requirements of a text-book. I am well aware that the highest type of literary composition is not of this conversational character, and that it may be to some readers a drawback rather than an attractive feature in the volume; but the fact is also recognized that the best style, theoretically, is not always the clearest and the most forcible, and that successful teachers have often to sacrifice beauty of rhetoric in order to impart their knowledge.

I have departed somewhat from the custom of anatomical authors in making diagrammatic illustrations—which it is my habit to draw upon the black-board before my classes, in order to make the listener use the eye as well as the intelligence as a means of gaining information—a prom-

inent feature of this volume. I have found, for some years, that the drawing of illustrations of this character before the eyes of the student gave a much clearer perception of some obscure points than words could effect, and had a great advantage in this respect over the most elaborate and skillfully executed plates. I have, therefore, incorporated many of my own designing, and some others which have been culled from different sources and modified to suit the demand of the moment. I have, in some instances, allowed the text to follow and explain these diagrams, as if the lecture were in actual progress, rather than to trust the descriptive text of the cuts alone to interpret their meaning.

The liberality of the publishers has enabled me to further ornament the work with the beautiful cuts of Sappey and Hirschfeld, some of which, to my knowledge, have never appeared in any American work, while I am indebted to my friend Professor Austin Flint, Jr., for some, culled from the same authors, which have appeared in his work upon physiology, and to my colleague and friend Professor William A. Hammond for some of the admirable photographs and woodcuts in his elaborate treatise on nervous diseases. I desire also to express my indebtedness to my friend Professor E. C. Seguin for some late monographs and some excellent diagrams, and to the works of Charcot, Ferrier, Brown-Séquard, Rosenthal, Hammond, Foster, Hilton, Flint, and others, as well as to the authors of such valuable monographs as those of Türck, Hughlings-Jackson, Vulpian, Pitres, Duret, Dodds, Notlmagel, Duchenne, Lockhart Clarke, Flechsig, and Erb, for the valuable assistance which I have derived from their labors. It has been my intention, as far as possible without disfiguring the text, to give all credit to those authors who have a

just claim to priority, where the originality of any matter is discussed, and to acknowledge my indebtedness to authors for extracts in foot-notes scattered throughout the volume.

The rapid strides which are being made in the interpretation of the symptoms of nervous diseases and the introduction of many new terms which must embarrass the reader of late treatises, unless he be educated up to the present standard of knowledge in this field of medicine, seem to the author a reasonable ground for belief that there is a demand for a volume which shall fit the practitioner and student to pursue his studies in this special line without embarrassment, if not with increased interest.

I have endeavored not to lose sight of the fact that the basis of the work was an anatomical one, and that, while the clinical points could be explained chiefly by anatomy, the treatment of nervous diseases had no place in the volume. For the reason, also, that the aim of the work is of a practical character, much detail of a purely descriptive kind has been deemed unimportant in some instances; while, again, facts which are too often slighted in descriptive treatises have been here given with unusual detail, as they seemed to me to suggest points of interest which had been overlooked or intentionally omitted by others.

It is not to be expected that many points stated in the physiology, symptomatology, or even in the anatomy, will not be open to discussion, and, possibly, to contradiction. It is almost impossible, to-day, for any two disputants upon nervous affections or nervous physiology to fail to find support for either side in the literature of the subject; but the statements which this volume contains will, it is to be hoped, receive the concurrence of those most advanced in this line of study.

With what merits or demerits the volume may possess, I intrust it to the public, conscious that an effort to clear up a field made obscure by visionary theories and endless speculation can not but contain some ground to which exception may be taken. To what extent it will supply the place of a guide in this—the labyrinth of medical science—experience alone must decide.

AMBROSE L. RANNEY.

NEW YORK CITY, 156 MADISON AVENUE,

*April 10, 1881.*



# TABLE OF CONTENTS.

---

	PAGES
GENERAL INTRODUCTION	1-16
THE NERVOUS SYSTEM CONSIDERED AS A WHOLE.	
ITS COMPONENT PARTS.	
THE GENERAL AXIOMS OF NERVE DISTRIBUTION.	
PART I.	
THE BRAIN	16-92
ITS ANATOMY, FUNCTIONS, AND CLINICAL ASPECTS.	
ITS GENERAL CONSTRUCTION.	
ITS WEIGHT, AND THAT OF ITS COMPONENT PARTS.	
ITS RAPIDITY OF GROWTH AND ALTERATIONS WITH AGE.	
ITS INDIVIDUAL GANGLIA.	
THE CEREBRUM	25-54
ITS SITUATION AND CONSTRUCTION.	
ITS CONVERGING AND COMMISSURAL FIBERS.	
ITS GENERAL FUNCTIONS AND SPECIAL CENTERS.	
Centers of motion; of speech; of vision; of hearing; of touch; of smell; of taste.	
THE FRONTAL LOBE.	
Its functions; motor centers; white substance.	
THE MOTOR AREA.	
Parts of the cerebrum comprised within it; situation of the special motor centers; diagnosis of cortical motor paralysis; effects of irritative lesions of the motor area.	
THE SENSORY AREA.	
Parts of the cerebrum comprised within it; effects of lesions within it.	
THE OCCIPITAL LOBE.	
Its relation to vision; psychical functions.	
THE TEMPORO-SPHENOIDAL LOBE.	
Its relation to vision; to ocular movements; to hearing; to olfactory sense; to taste; to tactile sensation.	
THE CORPUS STRIATUM AND OPTIC THALAMUS	54-58
SITUATION OF THE "BASAL GANGLIA."	
FUNCTIONS OF THE "BASAL GANGLIA."	

	PAGES
FUNCTIONS OF THE CAUDATE NUCLEUS.	
FUNCTIONS OF THE LENTICULAR NUCLEUS.	
THE CORPORA QUADRIGEMINA	58-59
THEIR RELATION TO VISION.	
THEIR RELATION TO OCULAR MOVEMENTS.	
THEIR RELATION TO COÖRDINATION OF MOVEMENT.	
THE CRURA CEREBRI AND PONS VAROLII	59-61
THEIR RELATION TO COÖRDINATION OF MUSCULAR MOVEMENT.	
THEIR RELATION TO CROSSED PARALYSIS.	
THEIR RELATION TO THE SENSATION OF PAIN.	
THEIR PROBABLE FUNCTIONS.	
THE CEREBELLUM	61-65
ITS NUMEROUS CONNECTIONS.	
EFFECTS OF LESIONS WITHIN ITS SUBSTANCE.	
CEREBELLAR ATAXIA.	
ITS RELATION TO HEARING AND SIGHT.	
THE MEDULLA OBLONGATA	65-68
ITS RELATION TO CRANIAL NERVES.	
ITS PHYSIOLOGICAL CENTERS:	
Respiratory; salivary; vaso-motor; diabetic; cardio-inhibitory; for deglutition; for vomiting; for movements of œsophagus and stomach; for digestive secretions.	
ITS RELATIONS TO COÖRDINATION OF MOVEMENT.	
THE SURGICAL BEARINGS OF CEREBRAL TOPOGRAPHY	68-74
GUIDES TO THE FISSURE OF ROLANDO.	
GUIDES TO THE EXTERNAL PARIETO-OCCIPITAL FISSURE.	
GUIDES TO THE FISSURE OF SYLVIIUS.	
GUIDES TO THE LIMITS OF THE "BASAL GANGLIA."	
GUIDES TO THE MOTOR CENTERS.	
GUIDES TO THE CENTER OF SPEECH.	
INDICATIONS AND CONTRAINDICATIONS FOR TREPHINING OF THE SKULL.	
The clinical significance of anæsthesia after an injury to the skull; of convulsive movements; of the Cheyne-Stokes respiration; of "choked disk" after an injury; of vomiting after an injury; of aphasia after an injury; of monoplegia after an injury.	
GENERAL SUMMARY OF THE ANATOMY OF THE BRAIN AND ITS CLINICAL ASPECTS	74-92
SUMMARY OF ITS GROSS ANATOMY.	
THE LOBES OF THE BRAIN.	
THE FISSURES OF THE BRAIN.	
THE LOBULES OF THE BRAIN.	
THE GYRI OF EACH LOBE.	
THE CLINICAL SUBDIVISIONS OF THE BRAIN.	
Symptoms referable to the base of the cerebrum; to the basal ganglia; to the white center of the hemispheres; to the in- ternal capsule; to the cortex of the hemispheres; to the cere- bellum.	

SUMMARY OF THE PHYSIOLOGY OF THE CEREBRAL CORTEX AND THE EFFECTS OF LESIONS INVOLVING IT.

The excitable portion (motor area)—its special centers and their action; the frontal convolutions; the parietal convolutions; the angular gyrus (probable center of vision); the superior temporo-sphenoidal gyrus (probable center of hearing); the center of speech.

CLINICAL DEDUCTIONS OF PRACTICAL VALUE.

Types of monoplegia and the special significance of each; convulsions of cerebral origin (Jacksonian epilepsy); embolism of middle cerebral artery and its effects; clinical significance of late rigidity of paralyzed muscles; general paralysis of the insane; lesions of the basal ganglia of the cerebrum: lesions of the internal capsule of the cerebrum; lesions of the white center of the hemispheres.

PART II.

THE CRANIAL NERVES 93-287

THEIR ANATOMY, PHYSIOLOGY, AND CLINICAL VALUE.

ENUMERATION, FROM BEFORE BACKWARD, AS THEY ESCAPE FROM THE CAVITY OF THE CRANIUM.

THE OLFACTORY NERVE 95-103

ITS ORIGIN AND CONSTRUCTION.

THE PECULIARITIES OF ITS FILAMENTS.

THE LIMITS OF ITS DISTRIBUTION.

THE PHYSIOLOGY OF OLFACTION.

THE ACT OF SNEEZING.

REFLEX ACTS DEPENDENT UPON THE OLFACTORY NERVE.

FUNCTIONS OF OLFACTORY NERVE IN ANIMALS.

RELATIONS OF THE SENSE OF SMELL TO THAT OF TASTE.

CLINICAL POINTS AFFORDED BY THE OLFACTORY NERVE.

“Hyperosmia,” its tests and causes; “anosmia,” its tests and causes.

THE OPTIC NERVE 103-127

THE OPTIC TRACTS, THEIR ORIGIN AND ATTACHMENTS.

THE OPTIC CHIASM, ITS CONSTRUCTION AND PHYSIOLOGY.

DISTRIBUTION OF OPTIC NERVE.

REFLEX ACTS EXCITED BY OPTIC NERVE.

DECUSSATION OF OPTIC FIBERS AND ITS PHYSIOLOGY.

RELATIONS OF THE OPTIC NERVE IN THE ORBIT.

ANATOMICAL DEFECTS OF VISION AND THEIR CONSEQUENCES.

“Hyperopia,” its tests, causes, and results; “myopia,” its tests, causes, and results; “astigmatism,” its tests, causes, and results.

CHANGES OBSERVED IN THE PUPIL.

Dilatation, its causes and physiology; contraction, its causes and physiology.

VISUAL SENSATIONS AND THEIR MODIFICATIONS.	
Muscæ volitantes; the "blind spot" of the retina; insensibility of the retina after firm pressure.	
THE PERCEPTION OF COLOR.	
Visual purple and its probable functions; rods and cones of the retina; Young-Helmholtz theory of color vision; limits of different color perceptions; color blindness.	
APPARENT VISION OF OBJECTS NOT REALLY SEEN.	
Its causes.	
EFFECTS OF OPTIC NERVE ON COÖRDINATION.	
Goltz's experiments.	
EFFECTS OF OPTIC NERVE ON THE LACHRYMAL APPARATUS.	
The act of winking the eyelid; effect of closure of eyelid upon the lachrymal canals.	
CLINICAL POINTS AFFORDED BY THE OPTIC NERVE.	
Hemianopsia, temporal, its causes; hemianopsia, nasal, its causes; hemianopsia, bi-nasal, its causes; hemianopsia, bi-temporal, its causes; amaurosis; hyperæsthesia of the optic nerve; amblyopia; atrophy of optic nerve.	
THE MOTOR OCULI NERVE	127-149
ITS ORIGIN, COURSE, AND DISTRIBUTION.	
THE PHYSIOLOGY OF CONTRACTION OF THE PUPIL.	
PHYSIOLOGICAL REASONS FOR THE DISTRIBUTION OF THE THIRD NERVE.	
MECHANISM OF THE DILATATION OF THE PUPIL.	
MOVEMENTS OF THE EYEBALL.	
DIAGNOSTIC ATTITUDES OF THE HEAD IN OCULAR PARESIS.	
CLINICAL POINTS PERTAINING TO THE THIRD NERVE.	
Megalopsia or macropsia; micropsia; ptosis; motor oculi paralysis; strabismus. Diseases of the ocular muscles: nystagmus; iritic spasm; contracture; paralysis; tabetic conditions; diplopia; strabismus.	
THE TROCHLEAR OR PATHETIC NERVE	149-151
ITS SUPERFICIAL AND DEEP POINTS OF ORIGIN.	
ITS COURSE AND RELATIONS WITHIN THE CRANIUM.	
ITS POINTS OF CLINICAL INTEREST.	
THE TRIGEMINUS NERVE	151-175
ITS SUPERFICIAL AND DEEP POINTS OF ORIGIN.	
COURSE OF ITS SENSORY AND MOTOR ROOTS WITHIN THE CRANIUM.	
ITS AFFERENT AND EFFERENT FIBERS.	
THE EFFECTS OF SECTION OF THE NERVE.	
On sensation; on mastication; on taste; on hearing; on sight; on smell.	
CLINICAL POINTS PERTAINING TO THE TRIGEMINUS NERVE.	
Neuralgia (tic-douloureux); spasm of the trigeminus; paralysis of its individual branches.	
DIAGNOSTIC VALUE OF THE TRIGEMINUS NERVE.	
Bleaching of the hair; immobility of temporo-maxillary joint; furring of the tongue; ulceration of the cornea; ulceration	

of the auditory canal; earache; pain in the scalp; conjunctival distribution.	
SURGICAL ANATOMY OF ITS MAIN BRANCHES.	
Section of the supra-orbital nerve; section of the supra-maxillary nerve; section of the inferior-dental nerve.	
THE GANGLIA CONNECTED WITH THE TRIGEMINUS NERVE.	
Ophthalmic, lenticular, or ciliary; spheno-palatine or Meckel's; otic; sub-maxillary.	
THE ABDUCENS NERVE (MOTOR OCULI EXTERNUS)	175-177
ITS SUPERFICIAL AND DEEP POINTS OF ORIGIN.	
ITS RELATION WITH THE OPHTHALMIC GANGLION.	
ITS CLINICAL RELATIONS.	
THE FACIAL NERVE	177-198
ITS SUPERFICIAL AND DEEP POINTS OF ORIGIN.	
ITS COURSE AND DISTRIBUTION.	
PHYSIOLOGY OF ITS MAIN BRANCHES.	
The petrosal nerves; the chorda tympani nerve; the "pars intermedia" of Wrisberg; the tympanic branch; the facial branches; the muscular branches.	
ITS COMMUNICATIONS WITH OTHER PARTS.	
Branches joining the fifth nerve; branch to the otic ganglion; branch to Meckel's ganglion; sympathetic fibers; its relation to deglutition and speech; its relation to smell; its relation to hearing; its relation to respiration.	
ITS FILAMENTS OF DISTRIBUTION.	
Physiological relation to deglutition; physiological relation to facial expression; physiological relation to mastication.	
CLINICAL POINTS PERTAINING TO THE NERVE.	
Spasm of the facial muscles. Bell's paralysis: intra-cranial variety; auditory variety; rheumatic variety; traumatic variety; syphilitic variety; diphtheritic variety; facial diplegia.	
THE AUDITORY NERVE	198-220
ITS SUPERFICIAL AND DEEP POINTS OF ORIGIN.	
ANATOMICAL STRUCTURE AND PECULIARITIES OF ITS FILAMENTS.	
ITS COURSE AND DISTRIBUTION.	
FUNCTIONS OF ITS VARIOUS BRANCHES.	
THE MECHANISM OF AUDITION.	
External ear, its construction and functions; middle ear, its construction and functions. Internal ear, its construction and functions: the semicircular canals; the vestibule. The cochlea: its scalæ; organ of Corti; membranes and ligaments.	
CLINICAL POINTS PERTAINING TO THE NERVE.	
Auditory vertigo—"Menière's disease"; injuries to the semicircular canals. Neuroses of the auditory nerve: acoustic hyperæsthesia; acoustic anæsthesia.	
THE GLOSSO-PHARYNGEAL NERVE	220-236
ITS SUPERFICIAL AND DEEP POINTS OF ORIGIN.	
ITS GANGLIONIC ENLARGEMENTS.	

ITS COURSE AND RELATIONS.	
ITS EFFERENT OR MOTOR FIBERS.	
ITS AFFERENT OR SENSORY FIBERS.	
ITS FIBERS OF TASTE.	
EFFECTS OF SECTION OF THE NERVE.	
On special sense of taste ; on deglutition.	
MECHANISM OF THE ACT OF DEGLUTITION.	
First period ; second period ; third period ; nerves involved ; importance of soft palate ; the nerve center for the act.	
CLINICAL POINTS PERTAINING TO THE NERVE.	
Glosso-labio-laryngeal paralysis—Duchenne's disease ; hypergeusia ; ageusia.	
<b>THE PNEUMOGASTRIC NERVE</b>	<b>236-259</b>
ITS SUPERFICIAL AND DEEP POINTS OF ORIGIN.	
ITS INTIMATE AFFILIATION WITH THE GLOSSO-PHARYNGEAL NERVE.	
ITS GANGLIONIC ENLARGEMENTS.	
THE INHERENT FIBERS OF ITS TRUNK.	
ITS BRANCHES OF DISTRIBUTION AND THEIR FUNCTIONS.	
The pharyngeal branches: effects on deglutition ; effects on voice. The laryngeal branches: their relation to phonation ; their relation to respiration ; their relation to spinal accessory nerve. The branches to alimentary canal: their relation to peristaltic action ; their relation to secretion. The cardiac branches: depressor nerve of heart's action ; effects of galvanism. Vaso-motor fibers: effects on blood-vessels. The pulmonary branches: their relation to respiration—acceleratory fibers ; inhibitory fibers.	
THE COURSE AND RELATIONS OF THE NERVE ON EACH SIDE OF THE BODY—	
With carotid artery ; with jugular vein ; with œsophagus ; with the lungs ; with the abdominal viscera.	
EFFECTS OF SECTION OF THE PNEUMOGASTRIC TRUNK.	
Upon the larynx ; upon the lungs ; upon the heart. Upon the digestive tract: stomach ; liver ; intestinal canal.	
CLINICAL POINTS PERTAINING TO THE NERVE.	
Pharyngeal anæsthesia ; pharyngeal spasm ; pharyngeal paralysis ; laryngeal spasm (Kopp's asthma) ; whooping cough ; aneurismal cough ; pulmonary asthma ; pulmonary vaso-motor paralysis ; angina pectoris ; cardiac neuralgia ; gastrodynia ; boulinia ; polydipsia ; dyspeptic vomiting ; polyphagia.	
<b>THE SPINAL ACCESSORY NERVE</b>	<b>259-272</b>
ITS SUPERFICIAL AND DEEP POINTS OF ORIGIN.	
ITS COURSE AND DISTRIBUTION.	
ITS FILAMENTS OF COMMUNICATION.	
ITS RELATIONS TO THE PRODUCTION OF VOICE.	
THE EFFECTS OF SECTION OF THE NERVE—	
On phonation ; on respiration ; on deglutition ; on the action of the heart ; on singing.	

CLINICAL POINTS PERTAINING TO THE NERVE.	
Tonic spasm of sterno-mastoid muscle; tonic spasm of trapezius; clonic spasm of sterno-mastoid and trapezius muscles; salaam convulsion of Newnham; unilateral paralysis of sterno-mastoid and trapezius muscles; bilateral paralysis of sterno-mastoid and trapezius muscles.	
THE HYPO-GLOSSAL NERVE (SUB-LINGUAL NERVE)	272-286
ITS SUPERFICIAL AND DEEP POINTS OF ORIGIN.	
ITS COURSE AND DISTRIBUTION.	
THE DESCENDENS NONI BRANCH.	
Functions of the nerve: on deglutition; on articulation.	
CLINICAL POINTS PERTAINING TO THE NERVE.	
Duchenne's disease: abnormalities of speech; abnormalities of voice; impairment of deglutition; facial deformity; lingual tremor. Lingual spasm: lingual paralysis.	

## PART III.

THE SPINAL CORD	287-352
ITS ANATOMICAL CONSTRUCTION, FUNCTIONS, AND CLINICAL BEARINGS.	
ITS CERVICAL AND LUMBAR ENLARGEMENTS.	
ITS FISSURES AND COLUMNS.	
ITS NERVES (THEIR ROOTS AND GENERAL CONSTRUCTION).	
ITS MEMBRANES AND THE CEREBRO-SPINAL FLUID.	
Their functions and situation.	
APPEARANCE OF A TRANSVERSE SECTION OF THE CORD.	
Its gray matter; its white matter; its central canal; its commissures. Pathological subdivisions of the cord: columns of Goll; columns of Burdach; columns of Türk; fundamental columns; direct pyramidal columns; anterior root zones; posterior root zones; crossed pyramidal columns; direct cerebellar columns.	
FUNCTIONS OF THE SPINAL CORD.	
(1) <i>Organ of conduction.</i>	
Paths of motor impulses; paths of sensory impulses; commissural fibers. Fibers of the spinal cord: motor fibers and their function; sensory fibers and their function; commissural fibers and their function.	
(2) <i>Spinal cord as a nerve center.</i>	
Reflex action of the cord; automatic action of the cord; vaso-motor centers; cilio-spinal center; genito-urinary center; tonic action on muscles; center of defecation; center of parturition; center of micturition; center of erection.	
(3) <i>Organ of coördination of muscular movements.</i>	

## CLINICAL POINTS PERTAINING TO THE SPINAL CORD.

The kinesodic system; the æsthesodie system; diseases of its substance.

## SYSTEMATIC LESIONS OF ÆSTHESODIC SYSTEM.

- (1) *Sclerosis of columns of Goll.*
- (2) *Sclerosis of columns of Burdach* (locomotor ataxia).

## SYSTEMATIC LESIONS OF KINESODIC SYSTEM.

- (1) *Sclerosis of columns of Türck.*
- (2) *Sclerosis of lateral columns* (spasmodic tabes, tetanoid paralysis, spastic spinal paralysis).
- (3) *Amyotrophic lateral sclerosis of the cord.*
- (4) *Myelitis of the anterior horns of the gray matter* (atrophic spinal paralysis).
- (5) *Polio-myelitis.*

Acute variety; infantile spinal paralysis; non-febrile variety; chronic variety.

- (6) *Progressive muscular atrophy.*
- (7) *Central myelitis.*

## NON-SYSTEMATIC OR "FOCAL" LESIONS OF THE CORD.

Distinctions between systematic and focal lesions; their physiological effects at different heights.

- (1) *Focal lesions of the upper cervical region.*  
Symptoms referable to the phrenic nerve; to the respiratory center; to the acceleratory center of the heart; to the pneumogastric nerve.
- (2) *Focal lesions of the cervical enlargement.*  
Symptoms referable to cilio-spinal center; to the ulnar nerve; to the acceleratory center of the heart; to the vaso-motor centers.
- (3) *Focal lesions of the mid-dorsal region.*  
Symptoms referable to the lower limbs; to the genito-urinary organs; to the reflex excitability of the spinal cord; to the lateral columns of the spinal cord; to the rectum.
- (4) *Focal lesions above the lumbar enlargement.*  
Symptoms referable to reflex excitability of the spinal cord; to the genito-urinary organs; to the rectum.
- (5) *Focal lesions of the lumbar enlargement of the spinal cord.*  
Symptoms referable to the sciatic nerve; to the rectum.
- (6) *Focal lesions of one lateral half of the spinal cord.*
  - (a) Spinal-hemiplegia—symptoms referable to the intercostal nerves; to the upper extremity; to the lower extremity; to the cilio-spinal center; to the vaso-motor centers.
  - (b) Hemi-paraplegia—symptoms referable to the trunk; to "trophic" centers; to increased excitability of the spinal cord; to the lower limbs.



## PART IV

	PAGES
THE SPINAL NERVES	353-486
THEIR SUBDIVISIONS AND POINTS OF ESCAPE.	
THE CONSTRUCTION AND RELATIVE SIZE OF THEIR ROOTS.	
THE LENGTH AND INCLINATION OF THEIR ROOTS.	
GENERAL AXIOMS OF NERVE DISTRIBUTION.	
THE UPPER CERVICAL NERVES	362-377
Table of their branches of distribution; the cervical plexus—its situation, formation, superficial branches, deep branches, and communications with other nerves. <i>The communicans noni nerve</i> : its origin and distribution. <i>The phrenic nerve</i> : its origin, course, surgical relations, and physiological function. Clinical points pertaining to the upper cervical nerves: cervico-occipital neuralgia; diaphragmatic neuralgia; clonic diaphragmatic spasm (hiccough); tonic diaphragmatic spasm (diaphragmatic tetanus); and diaphragmatic paralysis.	
THE LOWER CERVICAL NERVES	377-419
Table of their branches of distribution. The brachial plexus: its situation; its formation and abnormalities; its supra-clavicular branches; its infra-clavicular branches; its surgical relations; its communications with other nerves. Nerves of the upper extremity: table of the branches of the outer cord of the brachial plexus; table of the branches of the inner cord of the brachial plexus; table of the branches of the posterior cord of the brachial plexus. <i>The anterior thoracic nerves</i> : their distribution; their clinical aspects. <i>The external or musculo-cutaneous nerve</i> : its course and distribution to muscles; its cutaneous distribution; its relation to the "bent arm" after venesection. Clinical points afforded by it: paralysis and its symptoms; anæsthesia of forearm. <i>The median nerve</i> : its origin, course, and distribution; its surgical relations; its cutaneous distribution. Clinical points afforded by it: median paralysis and its symptoms; anæsthesia and its variations. <i>The internal and lesser internal cutaneous nerves</i> : their origin, course, and distribution; relations to the intercosto-humeral nerve. <i>The ulnar nerve</i> : its origin, course, and distribution; its surgical relations; its cutaneous distribution. Clinical points afforded by it: ulnar paralysis, its causes and symptoms; its relation to the surgery of the elbow joint. <i>The sub-scapular nerves</i> : their origin, course, and distribution; their surgical relations; their cutaneous distribution. Clinical points afforded by them: scapular paralysis. <i>The circumflex nerve</i> : its origin, course, and distribution; its surgical relations; its cutaneous and articular branches. Clinical points afforded by it: circumflex paralysis; deltoid atrophy. <i>The musculo-spiral</i>	

*nerve*: its origin, course, and distribution. Its terminal branches (the radial and interosseous nerves): their distribution to muscles; their cutaneous distribution. Clinical points afforded by it: surgical importance of its peculiar course; its relation to traumatic paralysis; rheumatic affections of the nerve. Lead paralysis: theories as to its etiology; its symptoms; its differential diagnosis; its duration.

#### THE DORSAL NERVES

419-436

*The thoracic intercostal nerves; the thoracico abdominal intercostal nerves*. their origin, course, and distribution; their relation to the pleura. Clinical points afforded by them: significance and diagnostic value of thoracic pain; significance of pain in the pit of the stomach; significance of pectoral pain; significance and course of pain due to the liver and other viscera. Intercostal neuralgia: its causes; its symptoms; its differential diagnosis. Neuralgia of the mammary gland (mastodynia): its causes and symptoms; its "puncta dolorosa." Paralysis of the dorsal nerves: its relations to kyphosis; its relations to scoliosis. Paralysis of the extensor muscles of the lumbar region: its diagnostic attitude; its differential diagnosis.

#### THE LUMBAR NERVES

436-457

*The lumbar plexus*: its situation and formation; its chief branches and their general distribution. *The ilio-hypogastric nerve*: its origin, course, and distribution; neuralgia of the nerve. *The ilio-inguinal nerve*: its origin, course, and distribution; neuralgia of the nerve; its relation to the peritonæum. *The external cutaneous nerve*: its origin, course, and distribution; its relation to pains referred to the thigh. *The genito-crural nerve*: its origin, course, and distribution. Clinical points afforded by it. *The anterior crural nerve*: its origin, course, and distribution; its physiological function; its distribution to joints; its cutaneous branches. Clinical points afforded by it: its surgical relations; its relation to pain in the region of the knee. Spasm of the quadriceps extensor muscle. Crural paralysis: its causes and symptoms. Atrophy of muscles supplied by this nerve. Crural neuralgia: its causes; its "puncta dolorosa"; the "spasmodic contracture of Stromeyer." *The obturator nerve*: its origin, course, and distribution; its distribution to joints; its relation to pain in the vicinity of the knee; its physiological functions. Clinical points afforded by it: obturator neuralgia; obturator paralysis. *The accessory obturator nerve*: its origin, course, and distribution; its abnormalities.

#### THE SACRAL NERVES

457-486

Their anatomical peculiarities. *The sacral plexus*: its shape and formation; its situation; its branches of distribution.

*The superior gluteal nerve:* its origin, course, and distribution; its physiological function. Clinical points afforded by it: peculiarities of its cutaneous distribution; its surgical relations; gluteal spasm; gluteal paralysis. *The muscular branches of the sacral plexus:* their distribution; their physiological functions. *The small sciatic nerve:* its origin, course, and distribution; its physiological functions; relation of its perineal branch to the genital organs. *The pudic nerve:* its origin, course, and distribution; the inferior hemorrhoidal nerve; the perineal nerve; the dorsal nerve of the penis. Clinical points afforded by the pudic nerve: its relations to coitus; its relations to micturition; its relations to defecation; neuralgic affection of its branches. *The great sciatic nerve:* its origin, course, and distribution; its distribution to joints. *The external popliteal nerve:* its course and branches of distribution. Distribution of nerves to the fascia of the leg. *The internal popliteal nerve:* its course and branches of distribution. Clinical points afforded by the great sciatic nerve and its branches. Sciatic neuralgia (malum Cotunnii): its causes; modifications of its seat; its characteristic symptoms; its "puncta dolorosa"; its motor manifestations; its vaso-motor effects. Spasms of the lower limb: spasmodic contracture of the hip; tonic and clonic spasms of extensor and adductor groups of muscles; spasm of the anterior muscles of the leg. Paralysis of the great sciatic nerve or its branches: sciatic paralysis; peroneal paralysis; tibial paralysis; their sensory manifestations; their trophic disturbances.



## LIST OF ILLUSTRATIONS.

---

FIG.		PAGE
1.	NERVE FIBERS FROM THE HUMAN SUBJECT <i>Kölliker</i>	5
2.	CERVICAL AND THORACIC PORTIONS OF THE SYMPATHETIC <i>Sappey</i>	6
3.	LUMBAR AND SACRAL PORTIONS OF THE SYMPATHETIC “	8
4.	FIBERS OF REMAK (Magnified) <i>Robin</i>	9
5.	MODE OF TERMINATION OF THE MOTOR NERVES <i>Rouget</i>	10
6.	A DIAGRAM OF THE BRAIN IN PROFILE <i>Quain</i>	20
7.	VERTICAL SECTION OF THE ENCEPHALON <i>Hirschfeld</i>	21
8.	A DIAGRAM OF THE BRAIN IN TRANSVERSE VERTICAL SECTION <i>Dalton</i>	22
9.	INFERIOR ASPECT OF THE ENCEPHALON <i>Hirschfeld</i>	23
10.	CONVOLUTIONS OF THE INTERNAL ASPECT OF THE HEMISPHERES <i>Sappey</i>	25
11.	A DIAGRAM OF THE FIBERS IN THE CEREBRUM <i>Le Bon</i>	27
12.	A DIAGRAM OF THE CEREBRAL CONVOLUTIONS <i>Dalton</i>	31
13.	STRUCTURE OF THE CEREBRAL CONVOLUTIONS <i>Baillarger</i>	33
14.	A DIAGRAM OF THE SENSORY AND MOTOR TRACTS OF THE BRAIN <i>Seguin</i>	35
15.	SIDE VIEW OF THE SPECIAL AREAS OF THE CEREBRAL CONVOLUTIONS <i>Ferrier</i>	39
16.	UPPER VIEW OF THE SPECIAL AREAS OF CEREBRAL CONVOLUTIONS “	41
17.	A DIAGRAM SHOWING THE COURSE OF NERVE IMPULSES IN THE BRAIN <i>Dodds</i>	53
18.	THE CORPORA STRIATA <i>Sappey</i>	55
19.	A DIAGRAM TO ILLUSTRATE “CROSSED PARALYSIS” <i>Hammond</i>	60
20.	THE CEREBELLUM AND MEDULLA OBLONGATA <i>Hirschfeld</i>	61
21.	ANTERIOR VIEW OF THE MEDULLA OBLONGATA <i>Sappey</i>	65
22.	OUTLINE OF THE SKULL AND ITS SURGICAL GUIDES <i>Topinard and Seguin</i>	70
23.	A DIAGRAM OF THE LOBES AND FISSURES OF THE CEREBRUM <i>Ferrier</i>	76

FIG.		PAGE
24.	A DIAGRAM OF THE CEREBRUM IN LONGI- TUDINAL MEDIAN SECTION	<i>Dalton</i> 76
25.	LATERAL VIEW OF THE SPECIAL AREAS OF THE CEREBRAL CORTEX	<i>Ferrier</i> 83
26.	SUPERIOR VIEW OF THE SPECIAL AREAS OF THE CEREBRAL CORTEX	" 87
27.	ROOTS OF THE CRANIAL NERVES	<i>Hirschfeld</i> 96
28.	OLFACTORY GANGLION AND NERVES	" 97
29.	TERMINAL FILAMENTS OF THE OLFACTORY NERVE	<i>Kölliker</i> 97
30.	INTERNAL BRANCHES OF THE OLFACTORY NERVE	<i>Sappey</i> 99
31.	OPTIC TRACTS, COMMISSURE, AND NERVES	<i>Hirschfeld</i> 104
32.	A DIAGRAM OF THE DECUSSATION OF THE OPTIC FIBERS	<i>Flint</i> 105
33.	A DIAGRAM OF THE OPTIC FIBERS IN THE RETINA	<i>Weber</i> 106
34.	RELATION OF THE OPTIC NERVE AND OPH- THALMIC ARTERY	<i>Ranney</i> 108
35.	RELATION OF THE OPTIC NERVE TO THE BLOOD-VESSELS, IN THE ORBIT	" 108
36.	A DIAGRAM OF THE DEFECTIVE DIAMETERS OF THE EYE	" 110
37.	ANTERIOR VIEW OF THE CRYSTALLINE LENS	<i>Babuchin</i> 116
38.	TWO CUTS OF THE RETINA AND ITS ELEMENTS	<i>Müller and Sappey</i> 117
39.	A DIAGRAM TO SHOW THE LIMITS OF COLOR VISION	<i>Hirschberg</i> 119
40.	LACHRYMAL AND MEIBOMIAN GLANDS	<i>Sappey</i> 121
41.	LACHRYMAL APPARATUS	" 122
42.	A DIAGRAM TO SHOW THE EFFECTS OF PRESS- URE ON THE OPTIC NERVE	<i>Ranney</i> 125
43.	DISTRIBUTION OF THE THIRD CRANIAL NERVE	<i>Hirschfeld</i> 128
44.	THE CILIARY MUSCLE, LENS, IRIS, AND COR- NEA	<i>Sappey</i> 129
45.	THE CILIARY NERVES AND CHOROID COAT OF EYE	" 130
46.	THE NERVES OF THE IRIS	" 131
47.	THE CILIARY NERVES	" 133
48.	A DIAGRAM SHOWING THE MECHANISM OF THE ACCOMMODATION OF VISION	<i>Fick</i> 134
49.	MUSCLES OF THE EYEBALL	<i>Sappey</i> 136
50.	A DIAGRAM SHOWING THE AXES OF ROTATION OF THE EYEBALL	<i>Fick</i> 139
51.	TWO DIAGRAMS OF THE ELEMENTS OF THE RETINA	<i>Müller and Sappey</i> 144
52.	DISTRIBUTION OF THE FOURTH CRANIAL NERVE	<i>Hirschfeld</i> 150
53.	THE OPHTHALMIC DIVISION OF THE FIFTH CRANIAL NERVE	" 152

FIG.		PAGE
54.	A DIAGRAM OF THE DISTRIBUTION OF THE FIFTH CRANIAL NERVE	<i>Flower</i> (Modified from) 154
55.	THE INFERIOR MAXILLARY DIVISION OF THE FIFTH CRANIAL NERVE	<i>Hirschfeld</i> 155
56.	THE SUPERIOR MAXILLARY DIVISION OF THE FIFTH CRANIAL NERVE	" 156
57.	SUPERFICIAL BRANCHES OF THE FIFTH AND FACIAL NERVES	" 157
58.	CUTANEOUS NERVE DISTRIBUTION OF THE HEAD	<i>Flower</i> 159
59.	DISTRIBUTION OF THE SIXTH CRANIAL NERVE	<i>Hirschfeld</i> 176
60.	THE SUPERFICIAL BRANCHES OF THE FACIAL NERVE	" 178
61.	A DIAGRAM OF THE BRANCHES OF THE FACIAL NERVE	<i>Ranney</i> 179
62.	EXPRESSION OF THE FACE IN "BELL'S PARALYSIS"	<i>Corfe</i> 181
63.	A DIAGRAM OF THE COMMUNICATIONS BETWEEN THE FACIAL AND TRIGEMINUS NERVES	<i>Ranney</i> 183
64.	THE CHORDA TYMPANI NERVE	<i>Hirschfeld</i> 185
65.	A DIAGRAM OF THE COURSE OF THE VIDIAN AND PETROSAL NERVES	<i>Ranney</i> 186
66.	A DIAGRAM OF THE AUDITORY NERVE AND ITS BRANCHES	" 198
67.	DISTRIBUTION OF THE COCHLEAR NERVE	<i>Sappey</i> 199
68.	GENERAL VIEW OF THE ORGAN OF HEARING	" 200
69.	A DIAGRAM TO ILLUSTRATE THE MECHANISM OF HEARING	<i>Ranney</i> 202
70.	THE OSSICLES OF THE TYMPANUM	<i>Arnold</i> 203
71.	THE BONY LABYRINTH OF A NEW-BORN CHILD	<i>Rüdringer</i> 204
72.	A DIAGRAM OF THE LABYRINTH, VESTIBULE, AND SEMICIRCULAR CANALS	" 205
73.	A DIAGRAM OF THE COCHLEA ON TRANSVERSE SECTION	<i>Ranney</i> 206
74.	A VERTICAL SECTION OF THE "ORGAN OF CORTI"	<i>Waldeyer</i> 207
75.	THE TWO PILLARS OF THE "ORGAN OF CORTI"	<i>Sappey</i> 208
76.	DISTRIBUTION OF THE COCHLEAR NERVES	" 209
77.	MEMBRANA TYMPANI, SEEN FROM WITHIN	<i>Rüdringer</i> 212
78.	SECTION OF THE COCHLEA OF THE CAT AND HUMAN FÆTUS	" 214
79.	THE GLOSSO-PHARYNGEAL NERVE	<i>Sappey</i> 222
80.	A DIAGRAM OF THE GLOSSO-PHARYNGEAL NERVE	<i>Ranney</i> 222
81.	THE PAPILLÆ OF THE TONGUE	<i>Sappey</i> 223
82.	A CIRCUMVALLATE PAPILLA	" 224
83.	THE FUNGIFORM AND FILIFORM PAPILLÆ	" 224
84.	THE TASTE-BUDS	<i>Engelmann</i> 226
85.	THE CAVITIES OF THE MOUTH AND PHARYNX	<i>Sappey</i> 228

FIG.		PAGE
86.	THE MUSCLES OF THE PHARYNX	<i>Sappey</i> 230
87.	ANASTOMOSES OF THE PNEUMOGASTRIC NERVE	<i>Hirschfeld</i> 237
88.	A DIAGRAM OF THE CERVICAL PORTION OF THE PNEUMOGASTRIC NERVE	<i>Ranney</i> 238
89.	A DIAGRAM OF THE THORACIC AND ABDOMINAL PORTIONS OF THE PNEUMOGASTRIC NERVE	" 241
90.	DISTRIBUTION OF THE PNEUMOGASTRIC NERVE	<i>Hirschfeld</i> 242
91.	NERVES OF THE LARYNX, POSTERIOR VIEW	<i>Sappey</i> 244
92.	NERVES OF THE LARYNX, LATERAL VIEW	" 244
93.	BRANCHES OF THE PNEUMOGASTRIC NERVE TO THE HEART	<i>Bernard</i> 245
94.	THE SPINAL ACCESSORY NERVE	<i>Hirschfeld</i> 260
95.	POSTERIOR VIEW OF THE MUSCLES OF THE LARYNX	<i>Sappey</i> 261
96.	LATERAL VIEW OF THE MUSCLES OF THE LARYNX	" 261
97.	A DIAGRAM OF THE SPINAL ACCESSORY NERVE	<i>Ranney</i> 262
98.	THE GLOTTIS, AS SEEN WITH THE LARYNGOSCOPE DURING THE EMISSION OF HIGH-PITCHED SOUNDS	<i>Le Bon</i> 263
99.	THE SPINAL ACCESSORY NERVE	<i>Sappey</i> 265
100.	DISTRIBUTION OF THE HYPO-GLOSSAL NERVE	" 283
101.	ANASTOMOTIC LOOP FORMED BY THE DESCENDING BRANCH OF THE HYPO-GLOSSAL NERVE AND THE INTERNAL DESCENDING BRANCH OF THE CERVICAL PLEXUS	<i>Hirschfeld</i> 274
102.	A DIAGRAM OF THE HYPO-GLOSSAL NERVE AND ITS BRANCHES	<i>Ranney</i> 275
103.	GLOSSO-LABIO-LARYNGEAL PARALYSIS	<i>Hammond</i> 278
104.	" " " "	" 279
105.	A DIAGRAM OF THE MOTOR POINTS OF THE FACE, SHOWING THE POSITION OF THE ELECTRODES DURING ELECTRIZATION OF SPECIAL MUSCLES AND NERVES	<i>Rosenthal</i> (Mod. from) 282
106.	THE CERVICAL PORTION OF THE SPINAL CORD	<i>Hirschfeld</i> 288
107.	THE DORSAL PORTION OF THE SPINAL CORD	" 288
108.	INFERIOR PORTION OF THE SPINAL CORD AND CAUDA EQUINA	" 288
109.	TRANSVERSE SECTION OF THE SPINAL CORD AT THE ORIGIN OF THE FIFTH PAIR OF CERVICAL NERVES	<i>Stilling</i> 289
110.	TRANSVERSE SECTION OF THE SPINAL CORD OF A CHILD SIX MONTHS OLD, AT THE MIDDLE OF THE LUMBAR ENLARGEMENT	<i>Gerlach</i> 291
111.	A SECTION OF THE SPINAL CORD BELOW THE MEDULLA OBLONGATA	<i>Sappey</i> 295
112.	A SECTION OF THE CERVICAL ENLARGEMENT OF THE SPINAL CORD	" 295



LIST OF ILLUSTRATIONS.

XXV

FIG.		PAGE
113.	A SECTION OF THE DORSAL REGION OF THE SPINAL CORD <i>Sappcy</i>	296
114.	A SECTION OF THE LUMBAR ENLARGEMENT OF THE SPINAL CORD “	296
115.	COLORING PLATE SHOWING THE SUBDIVISIONS OF THE SPINAL CORD <i>Hammond</i>	297
116.	A TRANSVERSE SECTION OF THE SPINAL CORD (Diagrammatic) <i>Seguin.</i>	298
117.	NERVE CELL FROM THE ANTERIOR HORN OF THE SPINAL CORD OF A CALF <i>Schultze</i>	303
118.	MULTIPOLAR NERVE CELL FROM THE ANTERIOR HORN OF THE SPINAL CORD OF THE OX <i>Deiters</i>	305
119.	TRANSVERSE SECTION OF THE GRAY SUBSTANCE OF THE SPINAL CORD <i>Gandry</i>	306
120.	COURSE OF MOTOR AND SENSORY PATHS IN THE SPINAL CORD <i>Brown-Séguard</i>	307
121.	NERVE CELLS FROM THE FLOOR OF THE RHOMBOIDAL SINUS IN MAN <i>Kölliker</i>	308
122.	A DIAGRAM TO SHOW THE DECUSSATION OF MOTOR NERVE FIBERS IN THE MEDULLA OBLONGATA <i>Flechsig and Seguin</i>	327
123.	ATROPHIC SPINAL PARALYSIS WITH CONTRACTURE <i>Hammond</i>	333
124.	PROGRESSIVE MUSCULAR ATROPHY OF THE UPPER EXTREMITY “	335
125.	PROGRESSIVE MUSCULAR ATROPHY. AGE OF PATIENT, FORTY-FIVE YEARS <i>Friedreich</i>	336
126.	A DIAGRAM SHOWING THE RELATION OF THE SPINOUS PROCESSES OF THE VERTEBRÆ TO THE SPINAL NERVES AND SPINAL CORD <i>Malgaigne and Seguin</i>	340
127.	A DIAGRAM TO SHOW THE COURSE OF THE MOTOR AND SENSORY PATHS IN THE SPINAL CORD. <i>Brown-Séguard</i>	349
128.	A DIAGRAM TO SHOW THE RELATION OF THE SPINOUS PROCESSES OF THE VERTEBRÆ TO SPINAL NERVES <i>Malgaigne and Seguin</i>	350
129.	THE CERVICAL PORTION OF THE SPINAL CORD <i>Hirschfeld</i>	356
130.	THE DORSAL PORTION OF THE SPINAL CORD “	356
131.	THE INFERIOR PORTION OF THE SPINAL CORD AND CAUDA EQUINA “	356
132.	POSTERIOR BRANCH OF THE SECOND CERVICAL NERVE <i>Arnold</i>	363
133.	SUPERFICIAL BRANCHES OF THE CERVICAL PLEXUS <i>Hirschfeld</i>	365
134.	THE NERVE SUPPLY OF THE POSTERIOR PART OF THE HEAD <i>Hilton</i>	366
135.	THE NERVE SUPPLY OF THE POSTERIOR PORTION OF THE HEAD AND NECK <i>Flower</i>	367

FIG.		PAGE
136.	A DIAGRAM OF THE BRACHIAL PLEXUS AND ITS BRANCHES	<i>Gray</i> 379
137.	ANTERIOR BRANCHES OF THE FOUR LAST CERVICAL AND FIRST DORSAL NERVES	<i>Hirschfeld</i> 380
138.	COLLATERAL BRANCHES OF THE BRACHIAL PLEXUS	" 381
139.	BRACHIAL PORTION OF THE MUSCULO-CUTANEOUS, MEDIAN, AND ULNAR NERVES	<i>Sappey</i> 386
140.	CUTANEOUS NERVES OF THE ANTERIOR SURFACE OF THE FOREARM AND HAND	<i>Hirschfeld</i> 389
141.	CUTANEOUS NERVES OF THE SHOULDER AND POSTERIOR SURFACE OF THE ARM	<i>Sappey</i> 391
142.	CUTANEOUS NERVES OF THE POSTERIOR SURFACE OF THE FOREARM AND HAND	" 392
143.	BRACHIAL PORTION OF THE MUSCULO-CUTANEOUS, MEDIAN, AND ULNAR NERVES	" 394
144.	TERMINAL PORTION OF THE MEDIAN AND ULNAR NERVES	" 394
145.	DIAGRAM OF THE REGIONS OF THE CUTANEOUS NERVE DISTRIBUTION ON THE ANTERIOR SURFACE OF THE UPPER EXTREMITY AND TRUNK	<i>Flower</i> 396
146.	THE CUTANEOUS NERVES OF THE SHOULDER AND ANTERIOR SURFACE OF THE ARM	<i>Hirschfeld</i> 399
147.	THE CUTANEOUS NERVES OF THE ANTERIOR SURFACE OF THE FOREARM AND HAND	" 399
148.	BRACHIAL PORTION OF THE MUSCULO-CUTANEOUS, MEDIAN, AND ULNAR NERVES	<i>Sappey</i> 401
149.	TERMINAL PORTION OF THE MEDIAN AND ULNAR NERVES	" 401
150.	THE CIRCUMFLEX AND SUBSCAPULAR NERVES	" 407
151.	THE MUSCULO-SPIRAL NERVE	" 409
152.	THE TERMINAL BRANCHES OF THE MUSCULO-SPIRAL NERVE	" 409
153.	A DIAGRAM OF THE REGIONS OF CUTANEOUS NERVE DISTRIBUTION ON THE POSTERIOR SURFACE OF THE UPPER EXTREMITY AND TRUNK	<i>Flower</i> (Modified from) 411
154.	THE MOTOR POINTS ON THE OUTER ASPECT OF THE ARM	<i>Rosenthal</i> " " 415
155.	THE MOTOR POINTS ON THE INNER SIDE OF THE ARM	" " " 416
156.	THE MOTOR POINTS ON THE EXTENSOR (POSTERIOR) ASPECT OF THE FOREARM	" " " 417
157.	THE MOTOR POINTS ON THE FLEXOR (ANTERIOR) ASPECT OF THE FOREARM	" " " 418
158.	THE INTERCOSTAL NERVES	<i>Masse</i> 421
159.	THE NERVES SITUATED ON THE POSTERIOR PART OF THE TRUNK	" 423

FIG.	PAGE
160. A DIAGRAM OF THE REGIONS OF CUTANEOUS NERVE DISTRIBUTION IN THE ANTERIOR SURFACE OF THE UPPER EXTREMITY AND TRUNK	<i>Flower</i> (Modified from) 425
161. A DIAGRAM OF THE REGIONS OF CUTANEOUS NERVE DISTRIBUTION ON THE POSTERIOR SURFACE OF THE UPPER EXTREMITY AND TRUNK	" " " 429
162. THE LUMBAR PLEXUS	<i>Hirschfeld</i> 435
163. THE CUTANEOUS NERVES OF THE THIGH	" 442
164. THE MUSCULAR BRANCHES OF THE ANTERIOR AND INTERNAL PORTIONS OF THE THIGH	<i>Sappey</i> 445
165. A DIAGRAM OF THE CUTANEOUS SUPPLY OF THE ANTERIOR ASPECT OF THE LOWER EXTREMITY	<i>Flower</i> (Modified from) 446
166. CUTANEOUS NERVES OF THE ANTERIOR PART OF THE THIGH	<i>Sappey</i> 449
167. DIAGRAM OF THE CUTANEOUS SUPPLY OF THE POSTERIOR ASPECT OF THE LOWER EXTREMITIES	<i>Flower</i> (Modified from) 451
168. MUSCULAR BRANCHES OF THE ANTERIOR AND INTERNAL PORTIONS OF THE THIGH	<i>Sappey</i> 453
169. THE SMALL SCIATIC NERVE WITH ITS BRANCHES OF DISTRIBUTION AND TERMINATION	" 465
170. THE GREAT SCIATIC NERVE WITH ITS BRANCHES OF DISTRIBUTION AND TERMINATION	" 470
171. THE EXTERNAL POPLITEAL NERVE	" 471
172. THE INTERNAL POPLITEAL NERVE	" 473
173. THE EXTERNAL SAPHENOUS NERVE AND ITS ACCESSORY, THE COMMUNICANS PERONEI	" 475
174. THE PLANTAR NERVES, THEIR COURSE, ANASTOMOSES, AND DISTRIBUTION	" 476
175. THE DEEP BRANCH OF THE EXTERNAL PLANTAR NERVE	" 477
176. THE MOTOR POINTS ON THE POSTERIOR ASPECT OF THE THIGH	<i>Rosenthal</i> (Mod. from) 480
177. THE MOTOR POINTS ON THE ANTERIOR ASPECT OF THE THIGH	" " " 482
178. THE MOTOR POINTS ON THE INNER ASPECT OF THE LEG	" " " 484
179. THE MOTOR POINTS ON THE OUTER ASPECT OF THE LEG	" " " 486



# GENERAL INTRODUCTION

*THE NERVOUS SYSTEM CONSIDERED AS A WHOLE, AND  
THE AXIOMS OF NERVE DISTRIBUTION.*



## GENERAL INTRODUCTION

---

GENTLEMEN : The subject of the nerves, which has been chosen as the theme of my winter's course of lectures, is one which probably comprises more points of practical interest than any other portion of anatomy. I say of practical interest, because there is hardly a field of medicine or of surgery where the nervous system does not help to explain many of the symptoms which might otherwise tend to possibly mislead the practitioner, and where it does not also afford invaluable aid in the diagnosis of obscure affections which might remain unrecognized, without a knowledge of the nerves and of their distribution and function, till the opportunity of relief to the patient has passed.

The distribution of those small nerve filaments which supply the skin of the body with sensation, and thus allow of the perception of external impressions, such as those of heat, cold, pain, and touch, possesses to-day an importance which is not confined to the researches of the physiologist, but which the advanced physician and surgeon are both keenly alive to grasp in all its practical detail.

In every work now published upon diseases of the nervous system, you will find plates, which, in less modern treatises, have no analogue ; which plates are designed to show the situation of certain *motor points* on the cutaneous surface of the different anatomical regions of the body, where the electric current can be best applied to accomplish certain desired effects.

The important relationship which exists between the nerves of the skin, the muscles underneath it, and the joints which those muscles move, is affording the enlightened physician a means of tracing the seat of obscure affections, by the use of certain *general rules* governing the nerve supply of the body, with a degree of accuracy and ease which strikes those, not familiar with the method, as remarkable.

The investigations of Charcot,<sup>1</sup> Ferrier,<sup>2</sup> Brown-Séguard,<sup>3</sup> Broca,<sup>4</sup> Bouillaud,<sup>5</sup> Andral,<sup>6</sup> and a host of others, have awakened the profession to the fact that many of the old ideas of the physiology of the brain and the spinal cord are radically wrong; and that, by symptoms referable to certain anatomical regions, the existence of disease in certain corresponding parts of the brain or spinal cord may be positively localized. To what extent this new guide to diagnosis, given us by means of experiments calculated to determine the precise distribution of the nervous system, may be developed in the future, time alone will show; but we have already ample proof that some positive information of a practical character has been gained, and much advance has been made in the accurate knowledge of the anatomy of the nervous centers.

When we consider that every act which distinguishes the animated being from the corpse is dependent upon the influence of the nerves, and that, without these electric wires, the heart would cease to throb, the lungs no longer perform their function, the eye no longer be capable of vision, the ear no longer perceive sound, and that smell, taste, expression, and movement would cease to exist, we can then understand how much of physiological interest must center around this special study, and how necessary is the thorough understanding of the distribution and function of the individual nerves, if we

<sup>1</sup> "Localizations dans les maladies cérébrales."

<sup>2</sup> "Functions of the Brain"; "Localization of Cerebral Disease."

<sup>3</sup> "Lectures on the Physiological Pathology of the Brain."

<sup>4</sup> "Bull. de la Soc. Anat.," 1861.

<sup>5</sup> "Recherches expérimentales sur les fonctions du cerveau." "Jour. de Physiologie," Paris, 1830. "Traité de l'Encéphalite," Paris, 1825.

<sup>6</sup> "Clinique Médicale."



ever hope to attain a comprehensive grasp of the general plan of our construction.

During the last session, I closed my course of lectures with a description of the general construction of nerves and the anatomy of the human brain. It will assist us, in our study of the distribution and practical utility of the separate nerves of the body, to hastily review the main classifications of nerves and the general plan upon which the nervous system is formed.

The nervous system of the human race consists of the following component parts :

- |                             |   |  |   |  |
|-----------------------------|---|--|---|--|
| 1st. Cerebro-spinal system. | } | The cerebro-spinal axis :                | } | Brain.<br>Medulla oblongata.<br>Spinal cord. |
|                             |   | The motor nerves.<br>The sensory nerves. |   |  |
- 2d. The sympathetic nerve.  
3d. Various ganglia, connected with special nerves.

The *cerebro-spinal axis* includes those nerve centers inclosed within the cavities of the cranium, and of the spinal

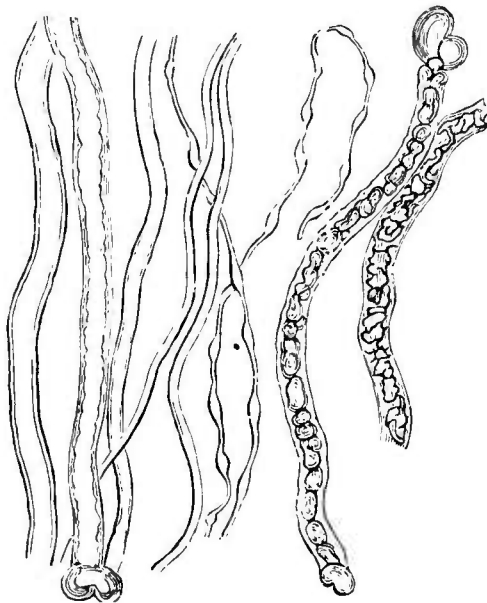

FIG. 1.—Nerve fibers from the human subject ; magnified 350 diameters. (Kölliker.)  
Four small fibers, of which two are varicose, one medium-sized fiber with borders of single contour, and four large fibers ; of the latter, two have a double contour and two contain granular matter.

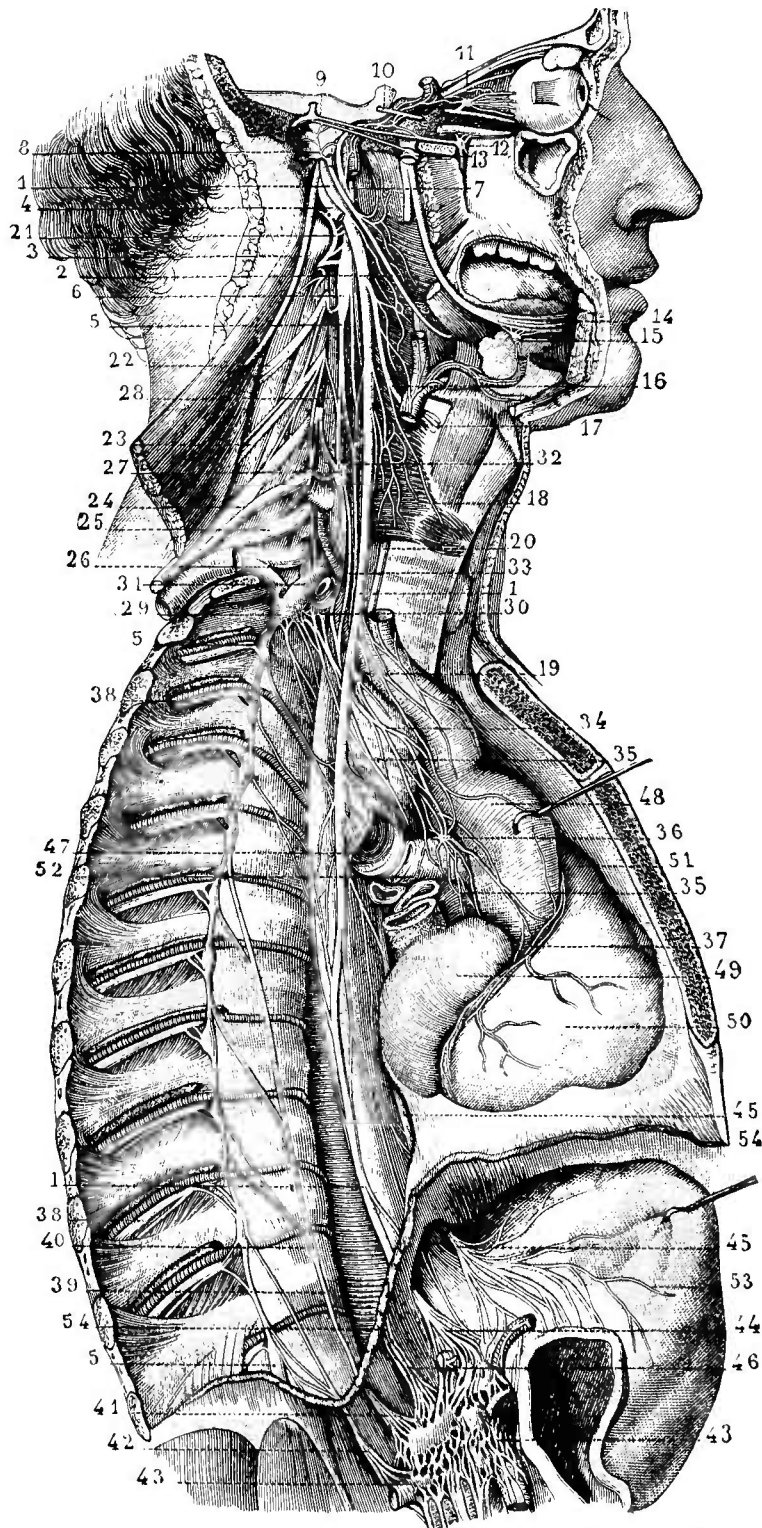

FIG. 2.—*Cervical and thoracic portion of the sympathetic.* (Sappey.)

1, 1, 1, right pneumogastrie; 2, glosso-pharyngeal; 3, spinal accessory; 4, divided trunk of the sublingual; 5, 5, 5, chain of ganglia of the sympathetic; 6, superior cervical ganglion; 7, branches from this ganglion to the carotid; 8, nerve of Jacobson; 9, two filaments from the facial, one to the sphenopalatine and the other to the otic ganglion; 10, motor oculi externus; 11, ophthalmic ganglion, receiving a motor filament from the motor oculi communis and a sensory filament from the nasal branch of the fifth; 12, sphenopalatine ganglion; 13, otic ganglion; 14, lingual branch of the fifth

nerve; 15, *submaxillary ganglion*; 16, 17, *superior laryngeal nerve*; 18, *external laryngeal nerve*; 19, 20, *recurrent laryngeal nerve*; 21, 22, 23, *anterior branches of the upper four cervical nerves, sending filaments to the superior cervical sympathetic ganglion*; 24, *anterior branches of the fifth and sixth cervical nerve sending filaments to the middle cervical ganglion*; 25, 26, *anterior branches of the seventh and eighth cervical and the first dorsal nerves, sending filaments to the inferior cervical ganglion*; 27, *middle cervical ganglion*; 28, *cord connecting the two ganglia*; 29, *inferior cervical ganglion*; 30, 31, *filaments connecting this with the middle ganglion*; 32, *superior cardiac nerve*; 33, *middle cardiac nerve*; 34, *inferior cardiac nerve*; 35, 35, *cardiac plexus*; 36, *ganglion of the cardiac plexus*; 37, *nerve following the right coronary artery*; 38, 38, *intercostal nerves with their two filaments of communication with the thoracic ganglia*; 39, 40, 41, *great splanchnic nerve*; 42, *lesser splanchnic nerve*; 43, 43, *solar plexus*; 44, *left pneumogastric*; 45, *right pneumogastric*; 46, *lower end of the phrenic nerve*; 47, *section of the right bronchus*; 48, *arch of the aorta*; 49, *right auricle*; 50, *right ventricle*; 51, 52, *pulmonary artery*; 53, *right half of the stomach*; 54, *section of the diaphragm*.

column, viz., the brain, medulla oblongata, and spinal cord. The second component part of the cerebro-spinal system, viz., the motor nerves, are *effluent nerves*, which carry the impulses of the nerve centers to the muscles. The third component part, the sensory nerves, are *afferent nerves*, which carry only sensory impressions from the periphery of the body to the nerve centers, viz., to the brain or spinal cord.

The *sympathetic nerve*<sup>1</sup> comprises a continuous chain of nerve fibers and ganglionic enlargements, which extends from the head to the coccyx, on both sides of the spinal column, and which is in constant communication, along its course, with branches of the cerebro-spinal system of nerves. It supplies branches to various ganglia of the thorax and abdomen, and helps to form the plexuses of nerves which ramify upon the coats of all the principal *blood-vessels*, and which accompany them throughout the length of their course. It is by means of these plexuses upon the blood-vessels that the sympathetic nerve is enabled to control the involuntary muscular fibers within the coats of the blood-vessels, and thus to regulate the *vascular supply* of the various tissues and organs of the body; and the nerve fibers of the sympathetic are therefore often called the “nerves of organic life,” since they regulate the life of tissues by controlling their blood supply, while the cerebro-spinal nerves are contradistinguished as the “nerves of animal life,” since they control those acts which are essential to the life of the individual, such as muscular

<sup>1</sup> See Fig. 2 and Fig. 3.

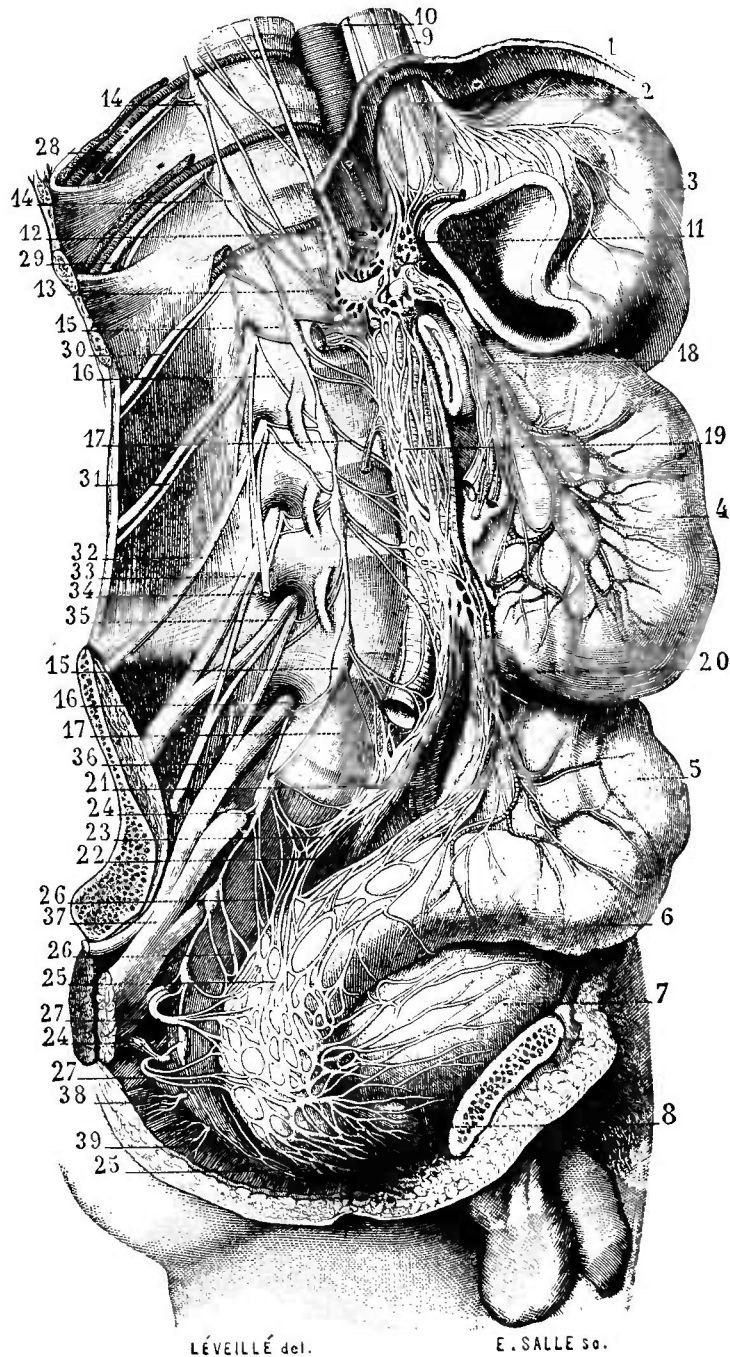

FIG. 3.—*Lumbar and sacral portions of the sympathetic.* (Sappey.)

- 1, section of the diaphragm; 2, lower end of the œsophagus; 3, left half of the stomach; 4, small intestine; 5, sigmoid flexure of the colon; 6, rectum; 7, bladder; 8, prostate; 9, lower end of the left pneumogastric; 10, lower end of the right pneumogastric; 11, solar plexus; 12, lower end of the great splanchnic nerve; 13, lower end of the lesser splanchnic nerve; 14, 14, last two thoracic ganglia; 15, 15, the four lumbar ganglia; 16, 16, 17, 17, branches from the lumbar ganglia; 18, superior mesenteric plexus; 19, 21, 22, 23, aortic lumbar plexus; 20, inferior mesenteric plexus; 24, 24, sacral portion of the sympathetic; 25, 25, 26, 26, 27, 27, hypogastric plexus; 28, 29, 30, tenth, eleventh, and twelfth dorsal nerves; 31, 32, 33, 34, 35, 36, 37, 38, 39, lumbar and sacral nerves.

movement, respiration, etc. The frequent communication between the sympathetic nerves and those of the cerebro-spinal system renders the actions of the two systems in perfect accord, and thus supports the universal *law of harmony* which is so beautifully illustrated in all the works of Nature.

The *cerebro-spinal nerves* comprise those which escape from the foramina of the cranium, called the *cranial nerves*, and those which are given off from the spinal cord, which escape from the spinal canal by means of foramina between the laminae of the vertebræ, called the "inter-vertebral foramina." These latter nerves are called *spinal nerves*, in contradistinction to the cranial nerves.

All of the spinal nerves arise by *two roots*, thus indicating that they are provided with both motor and sensory filaments, the former of which constitute the anterior and the latter the posterior root; while the cranial nerves are, in some instances, similarly constructed, as to having two distinct roots, while others have only one. The reason of this anatomical variation is explained by the fact that some of the cranial nerves are destitute of motor fibers, some of sensory fibers, while others are endowed with a special function, such as sight, smell, hearing, and taste.

In the course of lectures which I propose to deliver before you this winter, it is my intention not only to give the anatomical origin, course, and distribution of the various nerves, but also such points of practical value as may be suggested in connection with each, which will aid in remembering the peculiarities which each presents, and possibly to guide you in your practice at the bedside of the sick.

The study of the practical bearing of the distribution of the nerves is to-day assuming

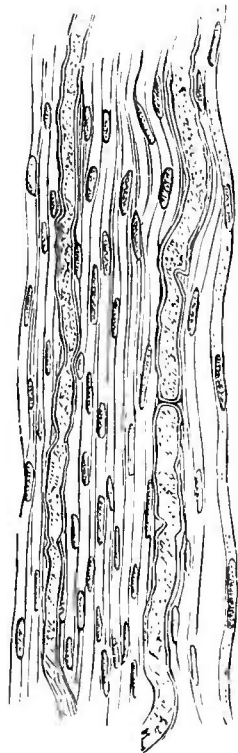

FIG. 4.—*Fibers of Remak; magnified 300 diameters.* (Robin.)

With the gelatinous fibers are seen two of the ordinary, dark-bordered nerve fibers.

an importance in diagnosis which can not be over-estimated ; while the physiological phenomena produced by them have a direct influence upon the proper performance of all those functions of the body which may be considered as vital to it.

It is claimed by John Hilton<sup>1</sup> that, if we trace the distribution of the motor nerve filaments from any special nerve trunk to the muscles, we shall find that only those muscles are supplied by each of the individual nerves which are required to render the performance of the *functions*, for which that nerve was designed, complete ; and that, if muscles were classified on a basis of their nerve supply, instead of in groups of mere relationship as to locality, a self-evident physiological relation would be shown which would tend greatly

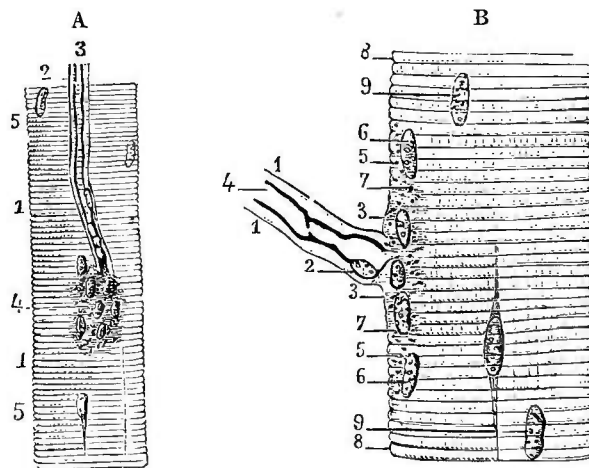

FIG. 5.—Mode of termination of the motor nerves. (Rouget.)

- A, primitive fasciculus of the thyro-hyoid muscle of the human subject, and its nerve tube: 1, 1, primitive muscular fasciculus; 2, nerve tube; 3, medullary substance of the tube, which is seen extending to the terminal plate, where it disappears; 4, terminal plate situated beneath the sarcolemma, that is to say, between it and the elementary fibrillæ; 5, 5, sarcolemma.
- B, primitive fasciculus of the intercostal muscle of the lizard, in which a nerve tube terminates: 1, 1, sheath of the nerve tube; 2, nucleus of the sheath; 3, 3, sarcolemma becoming continuous with the sheath; 4, medullary substance of the nerve tube ceasing abruptly at the site of the terminal plate; 5, 5, terminal plate; 6, 6, nuclei of the plate; 7, 7, granular substance which forms the principal element of the terminal plate, and which is continuous with the axis cylinder; 8, 8, undulations of the sarcolemma reproducing those of the fibrillæ; 9, 9, nuclei of the sarcolemma.

to simplify a knowledge of the muscular system in its practical bearings, and to prove a design on the part of the Creator.

<sup>1</sup> "Rest and Pain," London. (New York, 1879.)

Thus, he says, we frequently find muscles close together and still supplied by separate nerves, one of which has possibly to go a long way out of a direct course to reach it, which is contrary to the usual method of Nature, who always employs the simplest means to accomplish her designs; but, if we examine the *action* of these two muscles, we shall find that each one *acts in unison* with the *other muscles supplied by the same nerve*, and that to produce this perfect accord Nature takes what, to a hasty glance, would seem to be a needless step.

He also lays down certain axioms, pertaining to the distribution of nerves and the diagnostic value of pain, which will be often repeated in these lectures, and can not but be most profitable to those who use them as a guide. They are as follows:

*“Superficial pains on both sides of the body, which are symmetrical, imply an origin or cause, the seat of which is central or bilateral; while unilateral pain implies a seat of origin which is one-sided, and, as a rule, exists on the same side of the body as the pain.”*

The bearings of this first axiom will be rendered far more apparent when the regions of the neck and trunk are considered, since the symptom of *local pain* is of the greatest value in connection with diseases affecting the bones of the spinal column and the spinal cord which they invest; but the same rule may be applied to any of the cranial nerves, with a degree of certainty which seldom admits of error.

Thus Hilton reports a case where a fracture of the base of the skull, involving the orbit, produced amaurosis and tension of that region, with extreme local pain. A grooved probe, passed along the roof of the orbit, revealed pus, as was suspected to exist, which was evacuated by the separation of the blades of an ordinary dressing forceps.

As further examples of this axiom, a toothache may thus accompany an inflamed condition of the temporo-maxillary articulation, or it may create it. Again, opium introduced into the auditory canal will often instantaneously relieve

toothache and stiffness of the jaws, by having a narcotic effect upon the peripheral filaments of the same nerves, whose main trunks are distributed to the other regions mentioned as relieved.

Severe earache may result directly from the nervous irritation of a diseased tooth, since the filaments of the fifth nerve are distributed to both the ear and the teeth, and thus pain may be felt at a point apparently disconnected from the seat of irritation.

Earache is frequently the result of malignant ulceration of the tongue, since both regions receive a portion of their nervous supply from the fifth cranial nerve.

The second axiom is as follows :

*“ The same trunks of nerves, whose branches supply the groups of muscles moving a joint, furnish also a distribution of nerves to the skin over the insertions of the same muscles ; and the interior of the joint moved by these muscles receives a nerve supply from the same source.”*

By this axiom, a physiological harmony is created between these various coöperating structures. Thus any joint, when inflamed, may, by a reflex act through motor branches derived from the same trunk by which it is itself supplied, control the muscles which move it, and thus insure the rest and quiet necessary to its own repair.

Spots of *local tenderness* in the *cutaneous surface* may, for this reason, likewise be often considered as a guide to a source of irritation of some of the structures supplied by the same nerve, viz., the muscles underneath it, or the joints which are moved by them ; and thus even remote affections can be accurately determined, which, were this axiom not used as a guide, might escape recognition till an advanced stage of the disease had been reached.

It is well, however, to quote one other axiom, laid down by the same author, before leaving the subject of the diagnostic value of the cutaneous nerves as indicators of existing disease of other organs, viz. :

*“ Every fascia of the body has a muscle or muscles at-*



*tached to it, and every fascia must be considered as one of the points of insertion of the muscles connected to it, in following the previous axiom as to the cutaneous distribution of nerves."*

This guide is especially important in case the rule should be applied to the extremities (arms and legs) where these fasciæ extend over large surfaces, more or less remote from, and apparently unconnected with, the muscles attached to them; but it is mentioned in this connection, for the special object of calling your attention to those general rules which govern the distribution of the nerves in their entirety, before proceeding to apply them in all their individual bearings.

Without this nervous association between the muscular structures and those composing the joints, there could be no intimation given by the internal parts of their exhaustion or fatigue. Again, through the medium of this same association between the skin and the muscles, great security is given to the joints, by the muscles being made aware of the point of contact of any extraneous force or violence. Their involuntary contraction instinctively makes the tissues surrounding the joints tense and rigid, and this brings about an improved defense for the sub-adjacent joint structures.

From the conclusion of his great work, in which Hilton<sup>1</sup> endeavors to prove that mechanical rest may be used as a cure for most of the surgical disorders, the following sentences are quoted, since they can not be too often repeated:

*"I have endeavored to impress upon you the fact that every pain has its distinct and pregnant signification if we will but carefully search for it.*

*"From the pain which follows the intrusion of a particle of dust on to the conjunctiva, and the closure of the eyelid for the security of rest, up to the most formidable diseases which we have to treat, pain the monitor, and rest the cure, are starting points for contemplation, which should ever be present to the mind of the surgeon."*

Let us now pass to the special consideration of the brain

<sup>1</sup> *Op. cit.*

and each of the twelve nerves of the cranium, and note the more important facts presented by each, which may tend to elucidate its function, or to explain many direct and reflex phenomena which are often of great value in the diagnosis of obscure affections.

Later in the course, we will consider the anatomy of the spinal cord and the nerves which arise from it, noting, in each instance, such points as tend to elucidate the function of the part under consideration, and also such *clinical facts* as can be constantly applied in your daily association with the sick, when difficult questions of diagnosis arise, or when valuable suggestions, as to the methods of treatment employed, seem to be the direct outgrowth of your anatomical study.

Some three years since, my friend Professor E. C. Seguin addressed a class, in beginning a course<sup>1</sup> upon a somewhat similar subject, with words of counsel and earnest pleading for higher professional attainments, which are well worthy of repetition. I therefore quote them to you in the same spirit, trusting that they will kindle in you a renewed vigor and enthusiasm in this special department of science :

“ In practice, when we have completed the examination of a patient, several questions are put to us by the patient, by his friends, or by ourselves. These are, in chronological order : Is there disease ? Where is the disease ? What is the disease ? What are we to do for the cure of the disease or for the relief of the patient ? Will the patient die or recover ?

“ Of these questions, the one which our client and the world at large consider the most important is the fourth—that relating to treatment and cure. This preference is natural, but highly unscientific ; it is a manifestation of that untrained mental action which demands results and scorns methods, which welcomes empirical achievements (provided they be agreeable), and which conduces to the perpetuation of quackery of all kinds. But, to the physician who is not a mere prescription writer, who aims at infusing as much science into

<sup>1</sup> Delivered before the students of the College of Physicians and Surgeons of New York City, 1878.

his practice as possible, and who believes that he is not in the world for the purpose of gratifying his patients at so much per visit, but that he owes himself a debt of training and self-culture, and who has a sincere regard for science—to such a physician the first three questions assume a justly great importance. Pray observe that I do not say paramount importance, but great importance. And the superiority of the humanitarian over the scientific duty becomes less glaring if we bear in mind the truth—and I firmly believe it to be such—that success in treatment now depends, and in the future will still more closely depend, upon the scientific study of the human subject in health and disease. In other words, I would impress you with my own conviction that the best-trained and most scientific physician, if he be not a closet student and theorizer, is the best practitioner.

“We occasionally hear of an over-fine diagnosis, of extreme caution in the treatment of disease, and of the sweeping application of physiological laws to practice by men who are said to be ‘too scientific’; but who can number the errors, nay, the sacrifices of life, which must be laid at the door of the falsely so-called ‘practical men,’ who despise learning and scientific methods? Those of us who see something of the rarer and more formidable kinds of disease fully realize that in medicine, as probably in other applicable sciences, ignorance leads to rashness and crudity in practice, while ripe knowledge conduces to success, or, at any rate, to caution in prognosis and expectancy in treatment.

“Of the three diagnostic questions—Is there disease? Where is the disease? What is the disease?—the second is the one which forms the key-note of these lectures. Where is the lesion producing the disordered actions or symptoms? The method to be followed in arriving at the solution of this question varies somewhat in different departments of medicine. Some lesions can be seen by the trained unaided eye, or felt by the skilled hand; the seat of others can be determined by auscultation and percussion, by the aid of instruments, such as the ophthalmoscope, laryngoscope, speculum,

etc. But, in the study of the nervous system, greater difficulties are met with ; we are, to a great extent, deprived of these physical aids ; we can not appreciate the condition of the brain and spinal cord directly by our special senses, but only by a proper interpretation of the way in which the functions of these parts are performed. In other words, the diagnosis must be made chiefly by reasoning.”

To the words above quoted, I can add nothing, save an earnest endeavor to so place the subject matter before you as to render it within the grasp of your full comprehension, provided you, in turn, earnestly seek to master it.

# THE BRAIN

*ITS ANATOMY, FUNCTIONS, AND CLINICAL ASPECTS.*



## THE BRAIN

---

IT is with a sense of the difficulty of this task that I endeavor to select, from an enormous amount of experimental research regarding the anatomy of the encephalon, or brain, such points as seem to be of special interest, or which may be made a basis of reasoning when circumstances arise that demand analytical inquiry into the *probable cause* of any diseased condition which may exist. The anatomy of the brain is so complex that it can be treated of to advantage only by a minute and fully illustrated description, such as can be found either in exhaustive anatomical works or in treatises upon the special descriptive anatomy of the nervous system. In addition to this cause of impediment, we are, as yet, ignorant of the exact structure of many of its parts, and also of the arrangement and physiology of other portions.

The brain consists of a *number of ganglia* which are connected with each other, and also, by means of the different columns of the spinal cord, with the motor and sensory nerves of the head, the trunk, and the upper and lower extremities. The functions of some of these separate ganglia are more or less completely understood; but there still exist masses of gray substance scattered throughout the brain, the special physiological bearings of which are as yet obscure or completely unknown. The gray matter of the hemispheres of the cerebrum has been, and still is, a source of perplexity to the experimental physiologist; and while the fact seems proven that distinct portions of this large expanse of gray matter

have each some special function, it is still impossible, as yet, to say positively what the properties of each locality are.

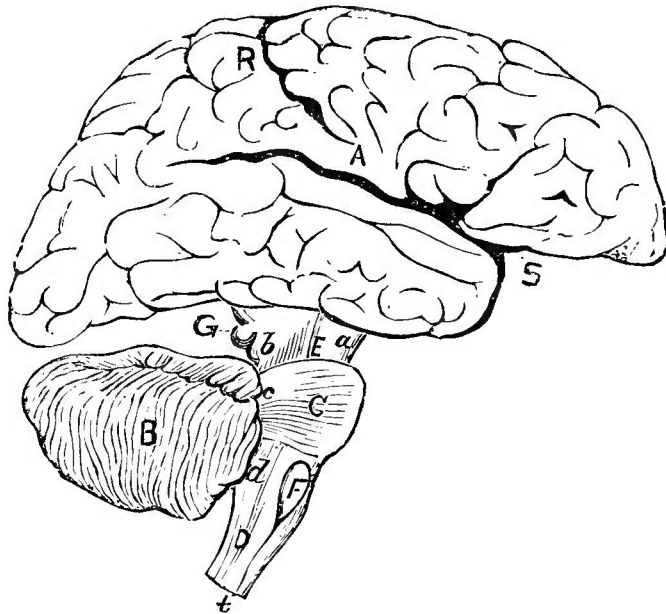

FIG. 6.—A diagram of the brain in profile. (Modified from Quain.)

This cerebrum is represented in this diagram as separated from the cerebellum more than it naturally should be, in order to show certain important parts. A, the cerebrum; B, the cerebellum; C, the pons Varolii; D, the medulla oblongata; E, the crus cerebri; F, the olivary body; G, the tubercula quadrigemina; S, the fissure of Sylvius; R, the fissure of Rolando; a, peduncles of cerebrum; b, superior peduncles of the cerebellum; c, middle peduncle of the cerebellum; d, inferior peduncles of the cerebellum; b, E, a, form the isthmus encephali.

If we confine ourselves, then, strictly to the limits of positive information, we can recognize only the following parts as distinct ganglia:<sup>1</sup> 1. The gray matter of the cerebral hemispheres; 2. The gray matter of the cerebellum; 3. The olfactory ganglia; 4. The gray matter of the corpora striata; 5. The gray matter of the optic thalami; 6. The tubercula quadrigemina; 7. The gray matter of the pons Varolii, or the tuber annulare; 8. The ganglion of the medulla oblongata.<sup>2</sup>

There are other parts of the encephalon which have been the field of speculation and investigation, but the positive knowledge gained has been of a purely anatomical character,<sup>3</sup> and little is yet known of their physiological import. As will

<sup>1</sup> See Figs. 6, 7, and 8 of this volume.

<sup>2</sup> Darling and Ranney, "Essentials of Anatomy." G. P. Putnam's Sons: New York, 1880.

<sup>3</sup> See articles by Flechsig, Luschka, Charcot, Lockhart Clarke, Dalton, Spitzka, and many others.



be mentioned in the description of the *deep fibers of origin*<sup>1</sup> of some of the cranial nerves, the anatomical arrangement may often suggest hypotheses which are attractive, and which tend to explain the object which Nature had in view in so

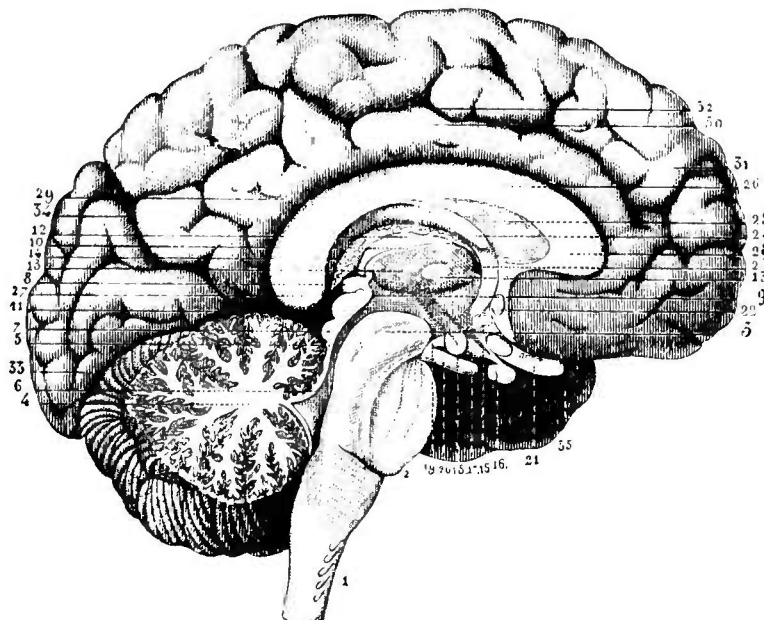

FIG. 7.—Vertical section of the encephalon. (Hirschfeld.)

1, *medulla oblongata* ; 2, *tuber annulare* ; 3, *cerebral peduncle* ; 4, *cerebellum* ; 5, *aqueduct of Sylvius* ; 6, *valve of Vieussens* ; 7, *tubercula quadrigemina* ; 8, *pineal gland* ; 9, *inferior peduncle* ; 10, *superior peduncle* ; 11, *middle portion of the great cerebral fissure* ; 12, *optic thalamus* ; 13, 13, *gray commissure* ; 14, *choroid plexus* ; 15, *infundibulum* ; 16, *pituitary body* ; 17, *tuber cinereum* ; 18, *bulb of the fornix* ; 19, *anterior perforated space* ; 20, *root of the motor oculi communis* ; 21, *optic nerve* ; 22, *anterior commissure of the cerebrum* ; 23, *foramen of Monro* ; 24, *section of the fornix* ; 25, *septum lucidum* ; 26, 27, 28, *corpus callosum* ; 29, 30, 31, 32, 33, 34, *convolutions and sulci of the cerebrum*. The olfactory ganglia and corpora striata are not shown in this section.

constructing the part; yet many of these theories depend upon well-observed clinical facts rather than upon experimental research.

The limited space of time which we can devote to this course of lectures will preclude the insertion of much that is purely anatomical, and thus a full comprehension of many of the points mentioned may be rendered difficult, unless you occasionally consult some of the text-books upon that subject, in case any of the terms used are unfamiliar. Many statements may also appear somewhat dogmatic, since it will

<sup>1</sup> See Lectures on "Optic, Third, and Fifth Nerves," in particular.

not be possible to enter into all the methods of investigation from which some of the conclusions have been drawn, or to quote authorities in support of every proposition where there chances to be a conflict of opinion.

WEIGHT OF THE BRAIN AND OF ITS COMPONENT PARTS.— That the shape of the cranium may be employed to estimate the relative size of the different parts of the encephalon, and that the circumference of the head and the height of the skull above the orifice of the ear may also relatively indicate the measurements of the cerebrum and its basal ganglia (which

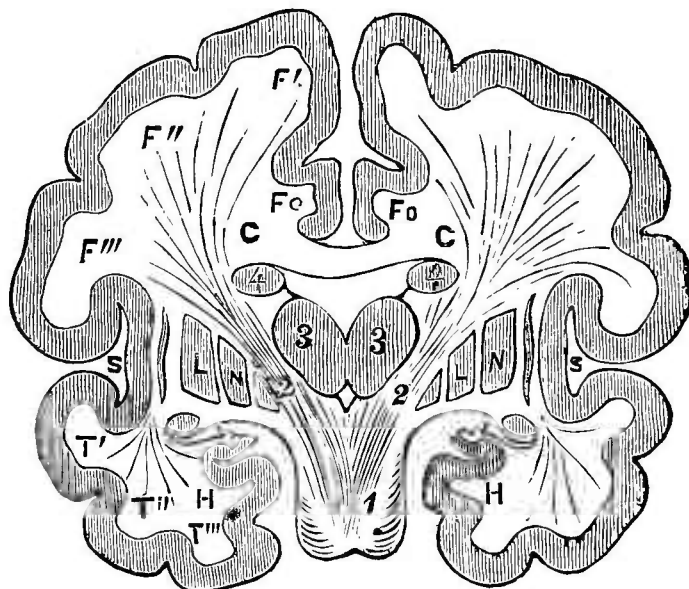

FIG. 8.—A diagram of brain in transverse vertical section. (After Dalton.)

1, crus cerebri ; 2, internal capsule ; 3, optic thalamus ; 4, corpus striatum ; C C, corpus callosum ; L N, lenticular nucleus ; S, fissure of Sylvius ; F o, gyrus fornicatus ; F', first frontal convolution ; F'', second frontal convolution ; F''', third frontal convolution ; T', first temporal convolution ; T'', second temporal convolution ; T''', third temporal convolution ; H, gyrus hippocampi.

are inclosed within it), have already been pointed out in previous lectures which I have delivered before you. The variations in the skulls of the different nations indicate an amount of brain which is in the direct ratio to the facial angle of Camper.<sup>1</sup> The average weight of the brain of a healthy adult of the Caucasian race has been given, by most of the promi-

<sup>1</sup> See article by the author on the "Osteology of the Head," "Medical Record," October 16, 1880.

nent investigators upon this subject, as about *fifty ounces* in the male, and some six ounces less in the female.<sup>1</sup> In the new-born infant, the weight of the brain, in the two sexes, is more nearly alike, being in the region of eleven ounces for

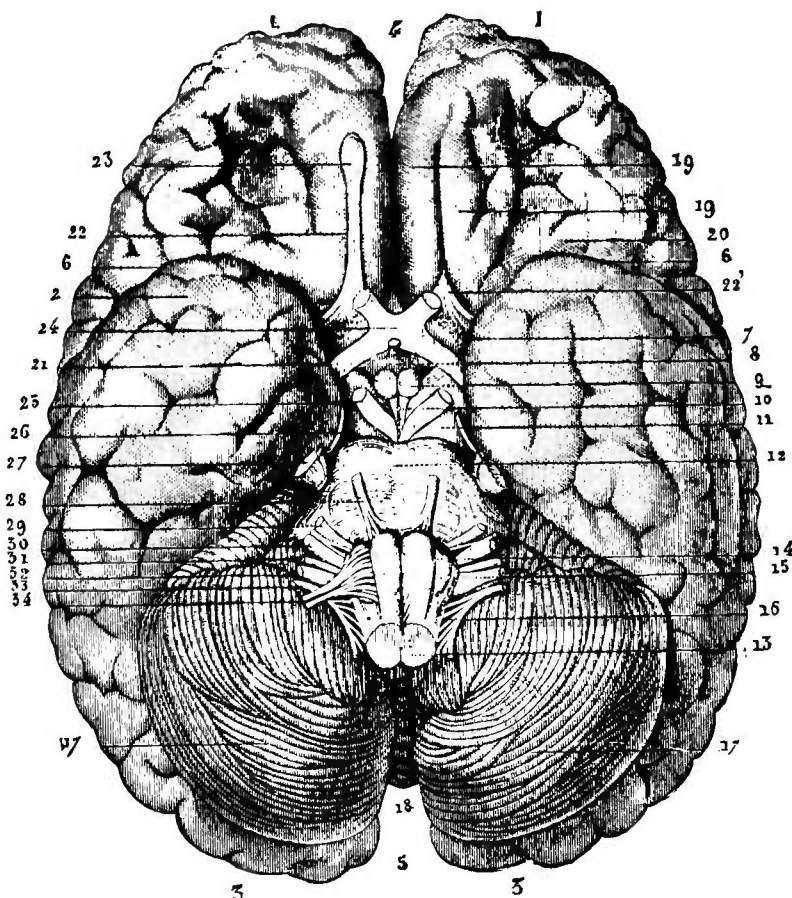

FIG. 9.—*Inferior aspect of the encephalon.* (After Hirschfeld.)

- 1, 1, anterior lobe of the cerebrum; 2, sphenoidal portion of the posterior lobe; 3, 3, occipital portion of the same lobe; 4, anterior extremity of the median fissure; 5, posterior extremity of the same; 6, 6, fissure of Sylvius; 7, anterior perforated space; 8, tuber cinereum and pituitary body; 9, corpora albicantia; 10, interpeduncular space (posterior perforated space); 11, crura cerebri; 12, pons Varolii; 13, medulla oblongata; 14, anterior pyramids; 15, olivary body; 16, restiform body (only partially visible); 17, 17, hemispheres of the cerebellum; 18, fissure separating these hemispheres; 19, 19, first and second convolutions of the inferior aspect of the frontal lobe with the intervening sulcus; 20, external convolutions of the frontal lobe; 21, optic tract; 22, olfactory nerve; 22', section of olfactory nerve, showing its triangular prismatic shape: the trunk has been raised to show the sulcus in which it is lodged; 23, ganglion of the olfactory nerve; 24, optic chiasm; 25, motor oculi; 26, patheticus; 27, trigeminus; 28, abducens; 29, facial; 30, auditory nerve and nerve of Wrisberg; 31, glosso-pharyngeal; 32, pneumogastric; 3, 3, spinal accessory; 34, hypo-glossal.

the male child and ten ounces for the female. The rapidity of growth of the brain is not uniform throughout the different periods of life, since it grows rapidly until the age of

<sup>1</sup> See researches of Reid, Tiedmann, Sims, and Quain.

seven years, then less rapidly until the age of forty is reached, when it attains its full development, and after that age it decreases in weight about one ounce for every period of ten years.

The comparative weights of the component parts of the encephalon are, in approximate figures, about *one fiftieth* of the entire weight for the pons Varolii and the medulla oblongata, taken together; *one tenth* of the entire weight for the cerebellum; and the *balance* of the total weight for the cerebrum and the basal ganglia inclosed within its substance. These proportions also show a slight variation in the two sexes, but not to so marked an extent as to render this statement far from a correct one.

It may be stated, as a rule, that the relative proportion of the cerebrum to that of the cerebellum is greater in the intellectual races; and that the cerebrum is developed in individuals in proportion to their intellectual power, although the absolute size may not be taken as a guide to the quality of the mind, since it is undoubtedly true that the brain can be improved, *in quality*, by exercise, as well as the muscular tissue. That there are important individual differences in the quality of the generating nervous matter is evidenced by the fact that some small brains actually accomplish more and better work than larger ones, and that many women often show a higher degree of mental acumen than men, in spite of the fact that they have brains which are lighter in avoirdupois.

From the most carefully prepared table of the weight of brain substance possessed by men of renown as intellectual giants, as well as those which revealed an unusual development of brain after death, contained in the work of a prominent author,<sup>1</sup> the following interesting facts are revealed:

The heaviest brains<sup>2</sup> on record (where the statements are to be relied upon) were possessed by a congenital imbecile and an ignorant bricklayer, both of whom outweighed Cuvier and

<sup>1</sup> A. Flint, Jr., "Text-Book of Physiology." D. Appleton & Co., New York.

<sup>2</sup> Congenital imbecile, aged thirty, 70½ ounces of brain substance; bricklayer, 67 ounces; Cuvier, 64½ ounces; Abercrombie, 63 ounces; Webster, 53½ ounces; Agassiz, 53¾ ounces.



above the tentorium cerebelli, since that membrane supports its posterior part. Its gray matter is not alone confined to its exterior surface, where it covers all of the convolutions and the sulci between them, but it is also present as two distinct collections, in the region of the floor of the brain called the *corpora striata*, and the *optic thalami*. To these latter collections of gray matter the term "*basal ganglia*" is applied, on account of their relative situation within the substance of the cerebrum.

While it will enable you to more clearly understand the functions of those parts, concerning which experiment or clinical observation has gained positive knowledge, by studying each of these basal ganglia apart from the cerebrum, still the general relation of the component parts of the hemispheres will have to be first mentioned, in order to properly appreciate the bearing of facts which will be discussed later in this chapter.

The gray matter which covers the exterior portion of each hemisphere of the cerebrum is connected with white nerve fibers, which may be divided into two classes; the first of which can be traced from the various parts of the exterior of the cerebrum toward the basal ganglia, while the second comprise certain curved commissural fibers, which pass into the white substance for a certain depth, and then return to the gray matter of the surface, thus serving to connect different convolutions with each other. The first set mentioned are called "*converging fibers*," since all the different points upon the large expanse of surface of the cerebrum send fibers which pass through either the corpus striatum or the optic thalamus of the same side,<sup>2</sup> and they thus present a converging appearance, on an appropriate section of the brain being made. We

<sup>1</sup> This ganglion, in each hemisphere, consists of two portions, called the "caudate nucleus" and the "lenticular nucleus," which are separated from each other by the so-called "internal capsule" of the cerebrum. These subdivisions are shown in Fig. 8 of this volume.

<sup>2</sup> This statement is only approximately correct, since the internal capsule is probably the chief path for these fibers. To what extent the basal ganglia are directly associated with the fibers of the cortex is, as yet, an unsolved problem.

know, from clinical facts associated with cases of cerebral hæmorrhage and cerebral softening, that the cerebrum must receive, by means of certain of these converging fibers, *sensory impressions* from other parts, as the normal perception of external objects is sometimes destroyed ; while we also know that, in the same type of cases, *motor impulses* are often destroyed, thus proving that motor fibers are also included among those which pass through the internal capsule or the basal ganglia. I think it can be, therefore, safely stated that the association between the gray matter of the cerebrum and both the motor and sensory nerve fibers is considered as proven, although some doubt may still exist as to the precise course of these fibers.

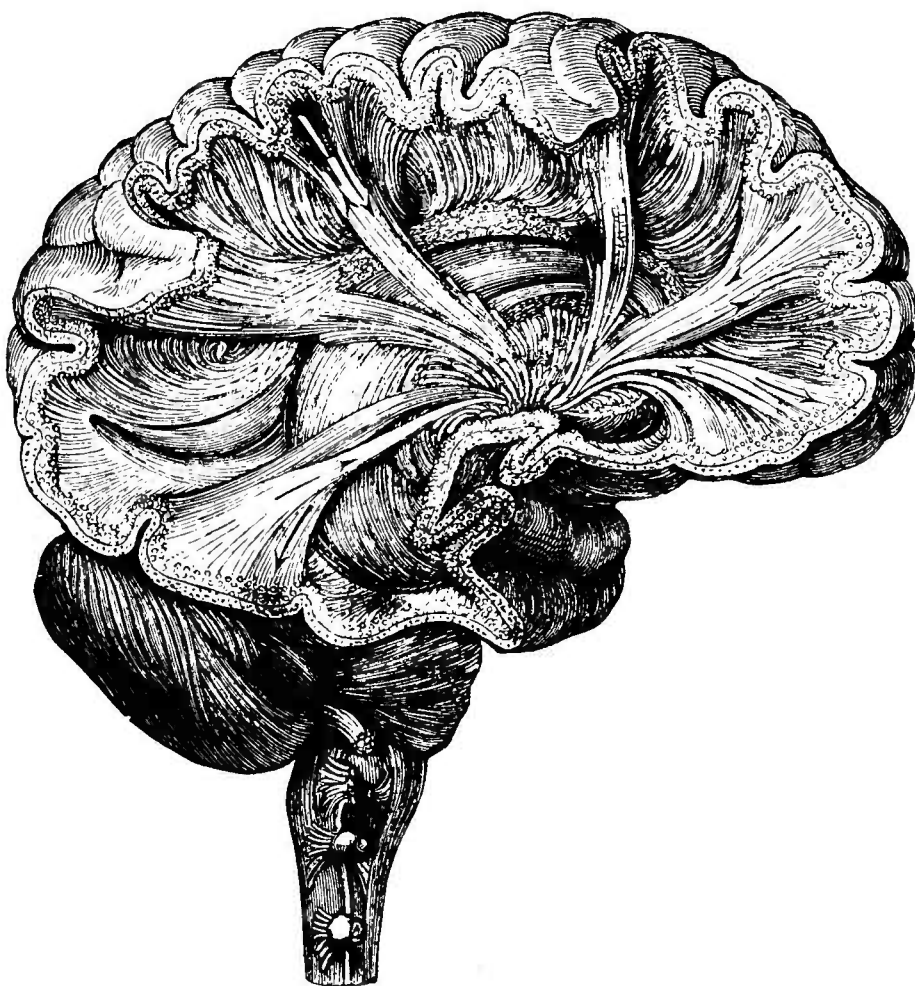

FIG. 11.—*Diagrammatic representation of the fibers in the cerebrum.* (Le Bon.)

FUNCTIONS OF THE CEREBRUM.—At the present day we are in possession of a sufficient number of facts, derived from

clinical observation, pathological research, and experimental investigation, to render it certain that no intelligence can exist without brain substance; that the destruction of brain substance impairs intellectual power; and that the normal use of the brain implies a degeneration of its substance and a constant process of regeneration, as exists in all tissues.

It was formerly supposed that the cerebrum was destitute of both sensation and irritability, since experiments seemed to show that no pain was experienced by removal of portions of the hemispheres, nor convulsive movements produced by direct stimulation of either the white or gray matter. It has therefore been claimed that the hemispheres could be called into action only in response to a sensory impression transmitted to its cells through sensory nerves, and that it was incapable of transmitting or appreciating artificial forms of stimulation. In 1870, however, Fritsch<sup>1</sup> and Hitzig<sup>2</sup> discovered that certain parts of the gray matter of the hemispheres of the brain of a dog responded to a weak galvanic current, and these investigators were thus enabled to locate centers where certain well-defined movements could be produced at will. These experimenters found (1) that the *centers of motion* were always confined to the *anterior parts* of the hemisphere; (2), that the action on muscles was a *crossed action*,<sup>3</sup> i. e., on the side opposite to the stimulation; and (3), that, after severe hæmorrhage, the excitability of the gray matter disappeared, thus possibly accounting for the negative results of previous experimenters in the same line.

The *centers of motion* discovered by these experiments seemed to be connected with parts which were widely separated, and arranged with little apparent system; thus the muscles of the neck were found to respond to galvanism of a center in the middle of the frontal convolution, while the cen-

<sup>1</sup> Reichardt u. du Bois-Raymond's "Archiv," 1870.

<sup>2</sup> Hitzig, "Das Gehirn," 1874.

<sup>3</sup> Brown-Séquard has shown that, in exceptional cases, this law may be not sustained by clinical facts. "Lancet," 1876. The anatomical researches of Flechsig, however, tend to explain the exceptions to the general rule (see pages of this volume referring to the fibers of the medulla oblongata).



ter adjoining it caused a response in the extensor and abductor muscles of the fore-leg, and others in movements of the eye and face. Ferrier<sup>1</sup> has of late repeated and confirmed the experiments of these German investigators.<sup>2</sup>

The effects of removal of the cerebral hemispheres of animals have been studied largely upon birds and the monkey tribe, and with results which are comparatively uniform. Without entering into detail as to all the effects which follow such a procedure, in case the basal ganglia are left intact, the general result may be given as follows: The animal seems to be able to execute all the movements natural to it, even when complex coördination of movement is required; but the *intelligence* seems to be impaired, and some unusual stimulus must be present to prompt any attempts at motion. As a result of this conclusion, the *mechanism of coördination* of movement is evidently not situated in the cerebral hemispheres.

Flourens,<sup>3</sup> from a series of experiments made in 1822 and 1823, concluded that the removal of the cerebrum entailed an entire loss of will power and also of the perceptive faculty, and that the memory was utterly destroyed. Bouillaud,<sup>4</sup> in 1826, proved the error of Flourens as regards the perceptive faculties, as *sight* and *hearing* were shown to be unaffected; and these results were still further made manifest by the researches of Longet,<sup>5</sup> who proved also that *taste* remained.

A careful study of the phenomena which accompany certain pathological lesions of the brain in the human subject, such as laceration or pressure from the effusion of blood, softening of the cerebral substance, etc., if taken in connection with the results of experiments upon living animals, throws considerable light upon the functions of certain distinct portions of the encephalon.

<sup>1</sup> "West Riding Reports," 1873; "Functions of the Brain," 1876.

<sup>2</sup> A large number of *distinct centers of motion* are mapped out by this author on a diagrammatic chart. The reader is referred to Fig. 15 of this volume.

<sup>3</sup> "Recherches expérimentales sur les propriétés et les fonctions du système nerveux," Paris, 1842.

<sup>4</sup> "Recherches expérimentales sur les fonctions du cerveau."

<sup>5</sup> "Anatomie et physiologie du système nerveux," Paris, 1842.

*Hæmorrhage within the brain substance* most commonly affects the *corpus striatum* or the *optic thalamus*; and it is now considered probable that, when the former ganglion is pressed upon, paralysis of *motion*, limited to the side of the body opposite to the lesion, is present, while, if the latter ganglion is pressed upon or destroyed, the *sensation* of the side of the body opposite to the lesion is proportionally impaired.<sup>1</sup> These facts illustrate the general course of both the motor and sensory fibers through the cerebrum, and their relation to the basal ganglia or the internal capsule.

In those exceptional cases of hæmorrhage where the white or the gray substance of the cerebral hemispheres is alone involved, without any pressure being exerted upon the basal ganglia or the internal capsule, *no paralysis* of either motion or sensation is usually produced, although a certain amount of weakness may often be perceived in the muscles of the side of the body opposite to the seat of the hæmorrhage.

*Softening of the cerebral hemispheres* and the degenerative changes which often follow an extravasation of blood into their substance are generally indicated by alterations in the intellectual condition of the patient, thus confirming the physiological experiments upon the hemispheres. Among the many forms in which this impairment of intellect may be manifested are recognized an impairment of memory; a tardy, inaccurate, and feeble connection of ideas; an irritability of temper, with a childish susceptibility to petty or imaginary annoyances; easily excited emotional manifestations; and a variety of phenomena denoting abnormally feeble intellectual power.<sup>2</sup>

Hughlings-Jackson<sup>3</sup> has shown that there is clear evidence to prove that disease of the gray matter of the convolutions of the hemispheres of the cerebrum may not only produce *delirium*, as in meningitis, but sometimes *convulsions*, either of

<sup>1</sup> This effect on sensation and motion is explained by some authors as the result of pressure upon the fibers of the *internal capsule*, and not the fibers of the basal ganglia.

<sup>2</sup> A. Flint, Jr., *op. cit.*

<sup>3</sup> "London Hosp. Reports," 1864; "Clin. and Phys. Researches," 1873.

an epileptiform character or confined to particular groups of muscles.

Landois<sup>1</sup> and Hitzig<sup>2</sup> both announced the fact that, when the motor areas upon the convex surface of the cerebrum,

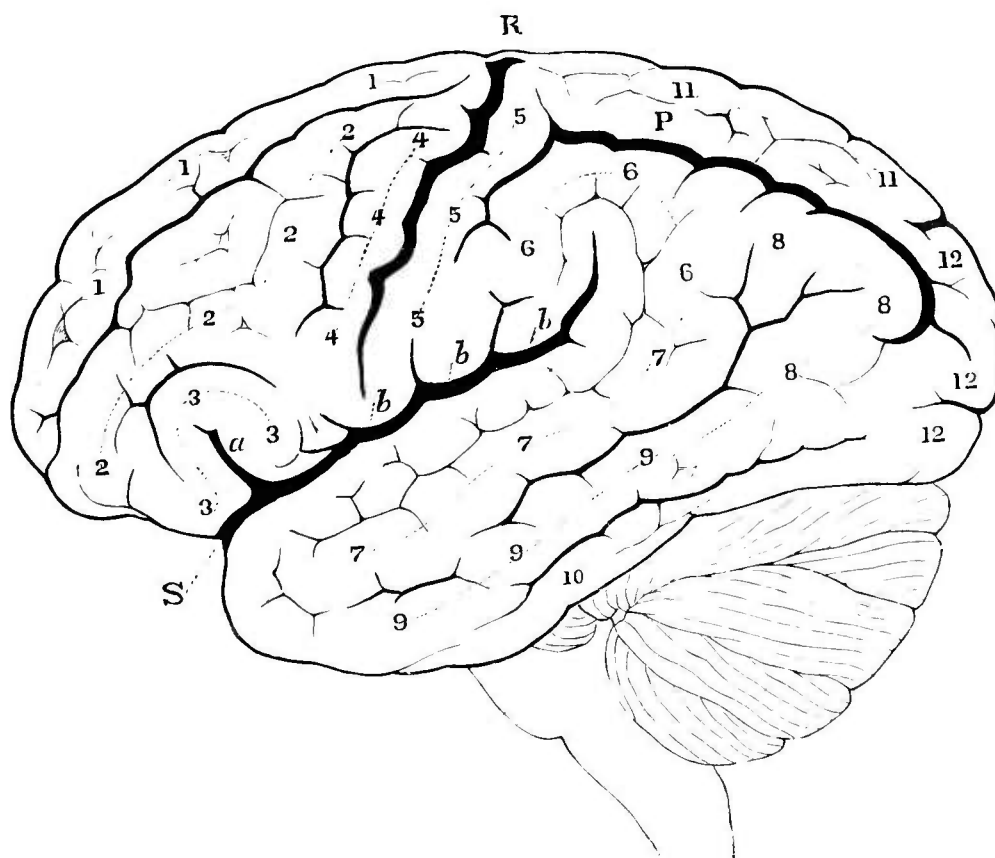

FIG. 12.—A diagrammatic figure, showing the cerebral convolutions. (After Dalton.)

S, Fissure of Sylvius, with its two branches *a* and *b*, *b*, *b*; R, fissure of Rolando; P, parieto-occipital fissure; 1, 1, 1, the first or superior frontal convolution; 2, 2, 2, 2, the second or middle frontal convolution; 3, 3, 3, the third frontal convolution, curving around the ascending limb of the fissure of Sylvius (*center of speech*); 4, 4, 4, ascending frontal (anterior central) convolution; 5, 5, 5, ascending parietal (posterior central) convolution; 6, 6, 6, supra-Sylvian convolution (parietal lobule), which is continuous with 7, 7, 7, the first or superior temporal convolution; 8, 8, 8, the angular convolution (or gyrus), the probable *center of vision*, which becomes continuous with 9, 9, 9, the middle temporal convolution; 10, the third or inferior temporal convolution; 11, 11, the superior parietal (supra-marginal) convolution; 12, 12, 12, the superior, middle, and inferior occipital convolutions (called also the first, second, and third). It is to be remembered that the term "gyrus" is synonymous with convolution," and that both terms are often interchanged. This cut may well be compared with that of Ferrier, which appears in the general summary of the clinical points of the brain.

which control the movements of the extremities, are excised, a rise in the temperature of the corresponding limbs takes

<sup>1</sup> Virchow's "Archiv," 1876.

<sup>2</sup> As quoted by Foster.

place and lasts for some months. A relationship has, moreover, been observed between the brain cortex and the beat of the heart (Balogh<sup>1</sup>); an alteration in the arterial pressure (Bochefontaine<sup>2</sup>); contraction of the bladder, spleen, and uterus; an increase in the flow of the saliva; and a dilating effect upon the pupil. The exact localization of some of these latter centers can not, as yet, be considered as positive.

Stimulation of the cerebral surface has been observed to result in a well-marked *hæmorrhage of the lungs* by Nothnagel.<sup>3</sup>

Ferrier<sup>4</sup> describes a “*visual*” center, the destruction of which creates blindness of the opposite eye; an “*auditory*” center; a “*tactile*” center; centers for *smell* and *taste*; and even a center for the *sensation of hunger*.

The center of *articulate speech* is perhaps one of the most definitely settled points in cerebral localization; and this is all the more interesting, since this is the only sharply defined faculty which has, as yet, been definitely localized.<sup>5</sup> There are two forms of aphasia, which are clinically recognized, viz., the *amnesic* and the *ataxic* varieties. In the former, the *memory of words* is utterly lost, so that the patient is not only unable to express his ideas in articulate sounds, but he is also unable to write them, thus showing that the words themselves have been forgotten. In the ataxic variety, however, the memory of words still remains, but the ability to so *coördinate the muscles of articulation* as to pronounce the words is impaired, so that the person so afflicted can write his ideas intelligently, but can not utter them. In either of these conditions, the disease which causes it must affect the center of the muscles of articulate speech or the center of articulate speech itself. It is not to be confounded, however, with other diseases where the ability to talk is apparently absent, such as occurs in the insane (who often refuse to converse from mere obstinacy), in those types of paralysis which affect

<sup>1</sup> Hofmann und Schwalbe's "Bericht," 1876.

<sup>2</sup> "Archives de Physiol.," 1876.

<sup>3</sup> "Obl. med. Wiss.," 1874.

<sup>4</sup> *Op. cit.*

<sup>5</sup> Some late authors refuse their concurrence with this statement, as several cases have been reported which tend to justify a doubt as to its accuracy.

the entire muscular mechanism associated with articulation, in hysteria, chorea, and nervous affections, and in the aphonia of laryngeal inflammation or paralysis.

The credit of the great discovery that the center of articulate speech could be localized in the *third convolution* of the *left anterior lobe* of the cerebrum is generally awarded to

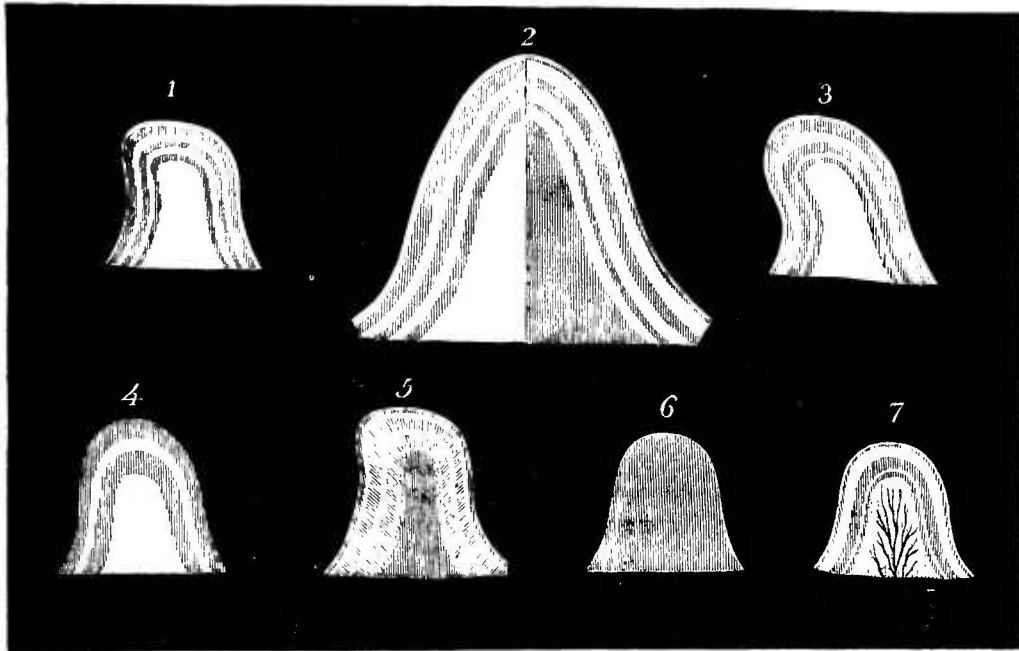

FIG. 13.—*Structure of the convolutions.* (After Baillarger.)

1, the six alternate gray and white layers in the cortical substance of the convolutions; 2, enlarged section of a convolution—the left half is seen by reflected light—layers arranged as in the preceding figure—in the right half, seen by transmitted light, the medullary layers are rendered dark by their opacity—the layers of gray substance, on the other hand, which are translucent, are represented in white; 3, section of a convolution showing the unequal thickness of the white layers—at first sight only three layers can be distinguished, two gray and an intervening white layer—more attentive examination shows six layers, the superficial and deep white layers being, however, very narrow; 4, section of a convolution showing the three layers of gray matter observed by Vieq d'Azyr in the occipital lobe; 5, tendency to radiation shown by the white fibers in the gray matter of the convolutions; 6, section of a cerebral convolution in a newly born infant, seen by reflected light—it presents an homogeneous appearance; 7, same section seen by transmitted light—presents the same stratification and tendency to radiation which are observed in the adult.

Broca.<sup>1</sup> Some twenty-five years before he made the profession alive to the investigation of the subject, however, the same impairment or loss of speech was shown to be a frequent accompaniment of hemiplegia of the right side of the body by Bouillaud and Marc Dax<sup>2</sup>; and in 1863, or thereabout, the

<sup>1</sup> Broca, "Bul. de la Soc. Anat.," 1861.

<sup>2</sup> A paper read before the Medical Congress at Montpellier in 1836.

views of Broca and of Hughlings-Jackson<sup>1</sup> were given to the profession, in which they both limited the lesion of aphasia to the parts supplied by the left middle cerebral artery. In 1863, the investigations also of the son of Marc Dax<sup>2</sup> located the lesion somewhere in the anterior or middle portion of the *frontal lobe* of the left side, and the results of still more recent investigations upon the subject seem to point to the "island of Reil" as the most frequent seat of this peculiar type of paralysis.

Viewing the fact that articulate speech is a thing learned by use, it has been suggested that, in most persons, one side of the brain only has been educated for that purpose; that we are, in fact, *left-brained* in respect to speech in the same way that we are right-handed in respect to many bodily movements.<sup>3</sup> In support of this theory the pathological fact is adduced that, in most people, the left hemisphere of the cerebrum is larger and more convoluted than the right.

While it is demonstrated that the cerebral lesion in aphasia involves, in the great majority of cases, the left side, still there have been several cases recorded where the right side has been shown to have been the seat of disease.<sup>4</sup> Such discoveries tend to cast a doubt upon the left side being more closely connected with the power of articulate speech than the right side, and some anatomists have endeavored to explain the frequency of the lesion upon the left side of the brain as a result of the fact that emboli (which are the most frequent cause of the disturbance to those parts supplied by the middle cerebral artery) find a much more *direct course upward* upon the left side than upon the right, in consequence of the angle at which the innominate artery leaves the arch of the aorta, which favors the passage of an embolus *by* rather than *into* its mouth; while the left carotid artery is situated at the

<sup>1</sup> Hughlings-Jackson, "Clinical and Physiological Researches on the Nervous System."

<sup>2</sup> M. G. Dax, as quoted by Dodds and A. Flint, Jr.

<sup>3</sup> Mich. Foster, *op. cit.*; Ferrier, "Functions of the Brain."

<sup>4</sup> Boyd, Broadbent, Bateman, Meissner, Bertin.

highest part of the arch, and its mouth is so directed as to arrest rather than avoid any floating particles in the blood current. In case of such movable particles being arrested either by the innominate or left carotid arteries, the most direct course in both instances will be toward the middle cerebral arteries, and thus aphasia will generally be produced with hemiplegia upon the side opposite to that where the embolus may be found.

THE FRONTAL LOBES.—There are innumerable cases on record where the frontal lobes of the cerebrum have suffered

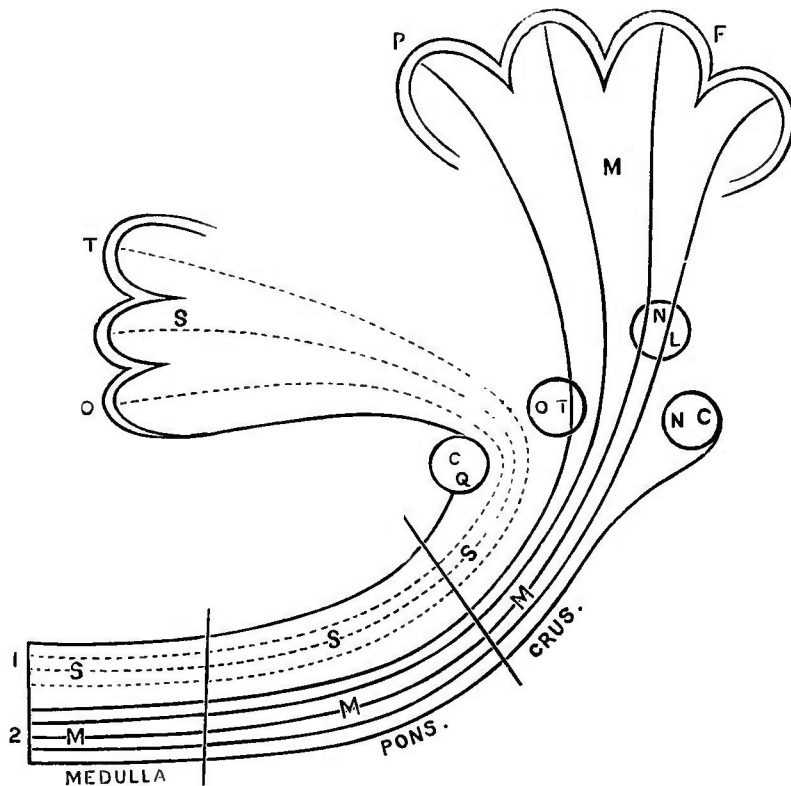

FIG. 14.—Diagram of the course of sensory and motor tracts in the meso-cephalon and hemispheres. (After Seguin.)

S, sensory tract in posterior region of meso-cephalon, extending to O and T, occipital and temporal lobes of hemispheres; M, motor tract in basis cruris, extending to P and F, parietal and (part of) frontal lobes of hemispheres; C, Q, corpus quadrigeminum; O, T, optic thalamus; N, L, nucleus lenticularis; N, C, nucleus caudatus; 1, the fibers forming the "tegmentum cruris" (Meynert); 2, the fibers forming the "basis cruris" (Meynert).

frightful lacerations and loss of substance, and yet recovery has taken place; and where disease of an extensive character has also produced negative results, both as regards motion and sensation.

A crowbar has been shot through the head, and recovery followed.<sup>1</sup> Again, Bouillaud<sup>2</sup> reports the passage of a bullet through the frontal lobes with a like result, and with no effect upon sensation or motion. Cases, somewhat similar, are recorded by Trousseau,<sup>3</sup> Congreve, Selwyn,<sup>4</sup> Pitres,<sup>5</sup> Morgagni, Marot,<sup>6</sup> Tavignot, and others, all of which go to prove the possibility of the most serious injury to this portion of the cerebrum without symptoms indicative of its presence. On the other hand, numerous cases of hæmorrhage and of abscess within the frontal lobes, as reported by Andral,<sup>7</sup> Hertz, Reed, Begbie, and others (quoted by Charcot and Ferrier), show the same *absence of positive diagnostic symptoms* either in sensory or motor paralysis.

From such sources of clinical reasoning, as well as from the physiological deductions which experiments upon animals have taught, the following conclusion of Ferrier<sup>8</sup> is of value to the reader: "With such evidence before us, we can not regard cases, in which, with lesions of the præfrontal lobes, sensation or motion has been affected, as other than *cases of coexistence* or of *multiple lesions*, whether organic or functional."

#### THE MOTOR REGIONS OF THE CEREBRUM.<sup>9</sup>

It may now be positively stated that the bases of the *three frontal convolutions*, the *convolutions* which bound the *fis-*

<sup>1</sup> Bigelow, "Am. Jour. of Med. Sciences," July, 1850; Harlow, "Recovery from the Passage of an Iron Bar through the Head"; "Reports of Mass. Med. Soc.," Boston, 1869.

<sup>2</sup> *Op. cit.*

<sup>3</sup> Quoted by Peter and Ferrier.

<sup>4</sup> London "Lancet," 1838.

<sup>5</sup> "Lésions du Centre Ovale," 1877.

<sup>6</sup> "Prog. Méd.," February and June, 1876.

<sup>7</sup> "Clinique Médicale."

<sup>8</sup> "Localization of Cerebral Disease," New York, 1880.

<sup>9</sup> Microscopic anatomy shows that the so-called motor gyri are rich in large cells; that they alone contain the "giant cells" of Betz ("Centralblatt," Nos. 37, 38), viz., ganglion cells, which in size and number of processes bear a remarkable resemblance to the unquestionably motor ganglion cells of the anterior horns of the spinal cord and the medulla oblongata. In the motor convolutions these giant cells are found in little clusters of three, five, or more, in a section, imbedded among the large ganglion cells of the third layer.



*sure of Rolando*, and the *para-central lobule*, upon the internal surface of each hemisphere of the cerebrum, are distinctly *motor* in their function. The distribution of the middle cerebral artery to this region gives to that vessel an importance not before appreciated; since it is now known that the four or five branches which are given off from the main artery each nourish a separate area of brain substance, and that emboli may obstruct either the trunk or some of its individual branches. It is thus possible to explain how the basal ganglia may still perform their functions while other parts supplied by some of the cortical branches may be impaired.

The preponderance of clinical testimony goes to show that most of the destructive lesions which are associated during life with paralysis of voluntary motion are confined to this motor area, although a rare case is on record<sup>1</sup> where the motor area was the seat of cystic disease, and still voluntary motion remained unaffected. It is a matter of great doubt whether the gray matter of the convolutions was impaired, even in this case, in spite of the existing lesion.

The effect of extensive lesions affecting the motor area of the monkey (which is commonly used for experiments, as the nearest approach to the type of mankind) may be summarized as follows: 1. A hemiplegia, which is at first absolute; 2. An improvement in associate, alternating, or bilateral movements, but no improvement in voluntary motion.

Respecting this point, I quote from a late work as follows:

“As examples of the improvement which follows the onset of the hemiplegia, the hand becomes more paralyzed than the arm, the arm more than the leg, and the lower facial movements more than the upper; while the muscles of the trunk are scarcely, if at all, affected.”<sup>2</sup>

<sup>1</sup> Samt, “Archiv für Psychiatrie,” 1874.

<sup>2</sup> Ferrier, “Localization of Cerebral Disease.”

In man the hemiplegia is usually on the side opposite to the existing lesion,<sup>1</sup> if the motor area, the corpus striatum, or the anterior part of the internal capsule be the seat of disease; and this paralysis is often accompanied by *convulsive muscular movements* or *rigidity* of the paralyzed parts, in its early stage, and, later on, by *rigidity* and *motor sclerosis*.<sup>2</sup>

The researches of Pitres<sup>3</sup> have shown that the same results as those dependent upon a lesion of the gray matter of the convolutions within the motor area follow when the lesion affects the *white substance* of the brain<sup>4</sup> which intervenes between the gray matter covering the motor area and the basal ganglia beneath them, and he thus urges a system of nomenclature of the different portions of the "centrum ovale" by means of sections of the brain made in certain regions so as to show special parts.

It is by means of these researches that we are enabled to explain those cases where rigidity or muscular spasms accompany an attack of hemiplegia, from an *effusion* into the *lateral ventricles* of the brain; and where *cerebral softening* or *hæmorrhage*, which does not affect the gray matter of the convolutions or the basal ganglia, produces a permanent paralysis of the side of the body opposite to the lesion.

When sudden hemiplegia occurs, as a result of hæmorrhage into or traumatism of some portion of the motor area, the condition of paralysis is liable to improve in those regions of the body where the *special motor center of that part* remains unimpaired, but the paralysis will usually remain permanent in that part of the body whose motor center is destroyed. This fact, when properly interpreted, may often prove a most valuable guide in diagnosis.

<sup>1</sup> The fact that all the motor fibers do not decussate in the medulla oblongata (Flechsig) explains the exceptions to this rule.

<sup>2</sup> See later pages of this volume for further explanation of this point and its clinical interest.

<sup>3</sup> "Lésions du Centre Ovale," Paris, 1877.

<sup>4</sup> This portion contains the fibers of the *internal capsule* radiating to reach the motor regions of the cortex. (See Fig. 8.)

*Special Centers of Motion.*—At the base of the *first frontal convolution*, and extending slightly into the *second frontal convolution*,

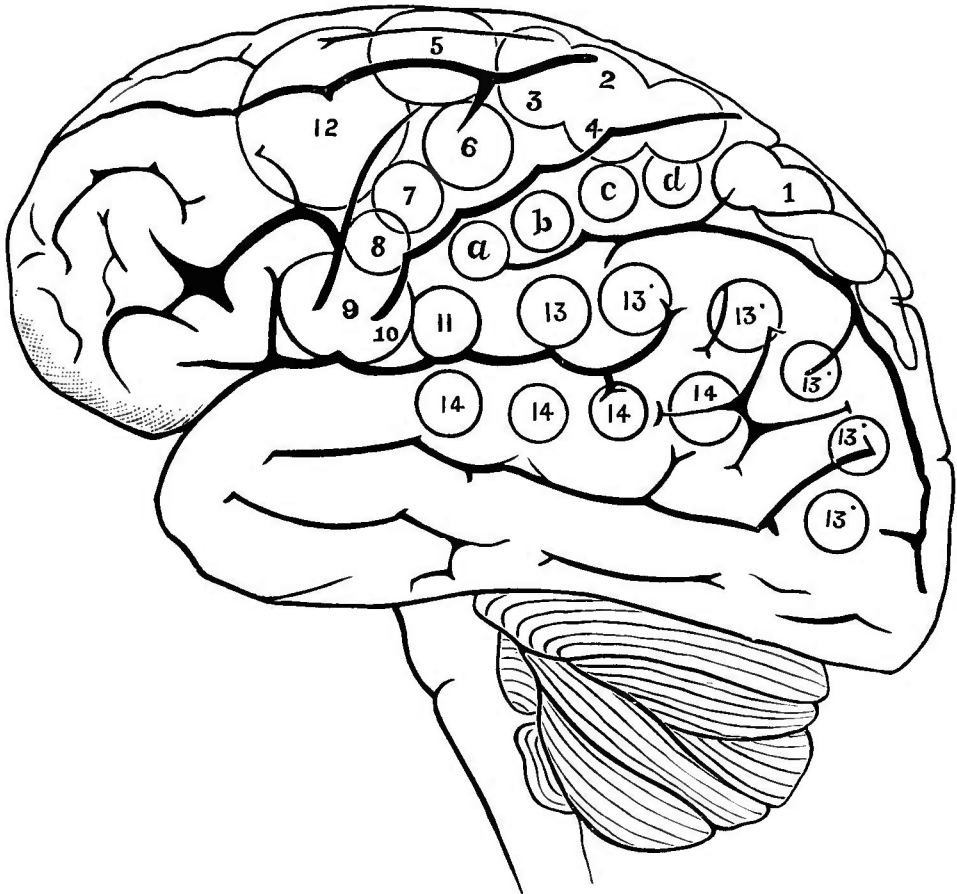

FIG. 15.—*Side view of the brain of man and the areas of the cerebral convolutions.* (After Ferrier.)

1 (on the postero-parietal [superior parietal] lobule), advance of the opposite hind-limb as in walking; 2, 3, 4 (around the upper extremity of the fissure of Rolando), complex movements of the opposite leg and arm, and of the trunk, as in swimming; *a*, *b*, *c*, *d* (on the postero-parietal [posterior central] convolution), individual and combined movements of the fingers and wrist of the opposite hand: prehensile movements; 5 (at the posterior extremity of the superior frontal convolution), extension forward of the opposite arm and hand; 6 (on the upper part of the antero-parietal or ascending frontal [anterior central] convolution), supination and flexion of the opposite fore-arm; 7 (on the median portion of the same convolution), retraction and elevation of the opposite angle of the mouth by means of the zygomatic muscles; 8 (lower down on the same convolution), elevation of the ala nasi and upper lip with depression of the lower lip, on the opposite side; 9, 10 (at the inferior extremity of the same convolution, Broca's convolution), opening of the mouth with 9, protrusion, and 10, retraction of the tongue—region of aphasia, bilateral action; 11 (between 10 and the inferior extremity of the postero-parietal convolution), retraction of the opposite angle of the mouth, the head turned slightly to one side; 12 (on the posterior portions of the superior and middle frontal convolutions), the eyes open widely, the pupils dilate, and the head and eyes turn toward the opposite side; 13, 13' (on the supra-marginal lobule and angular gyrus), the eyes move toward the opposite side with an upward 13, or downward 13' deviation; the pupils generally contracted (center of vision); 14 (of the infra-marginal, or superior [first] temporo-sphenoidal convolution), pricking of the opposite ear, the head and eyes turn to the opposite side, and the pupils dilate largely (center of hearing). Ferrier, moreover, places the centers of taste and smell at the extremity of the temporo-sphenoidal lobe, and that of touch in the gyrus uncinatus and hippocampus major.

*tal convolution*, in the brain of a monkey may be located a distinct center which exerts a special influence upon the head and eyes. Thus, to quote from Ferrier, whose researches have been remarkable for their originality and apparent accuracy, stimulation of this center causes “*elevation of the eyelids, dilatation of the pupils, conjugate deviation of the eyes, and turning of the head toward the opposite side.*” (See No. 12 in Fig. 15.)

That this same center seems to exist in the human brain is to be inferred from the cases where a *bilateral deviation of the eyes* has been observed, which, in some cases, has also been associated with a lateral deflection of the head. This subject has excited the interest of Hughlings-Jackson,<sup>1</sup> Priestley Smith,<sup>2</sup> Ferrier,<sup>3</sup> and Charcot,<sup>4</sup> and casés which seem to sustain the theory of an oculo-motor function in the frontal convolutions have been reported by Chouppe, Landouzy,<sup>5</sup> Carroll, Smith, and others. An effort has been made to explain these ocular symptoms by some association with the angular gyrus (see page 52), but apparently without much ground.

The center of *motion for the muscles of the limbs* is not yet as positively ascertained as the oculo-motor center, although some interesting experiments have been made to decide whether the corresponding point of the brain of man is analogous, in its control over the leg, to that of the monkey tribe. As an example of the ingenuity shown in research, Bourdon<sup>6</sup> has endeavored to demonstrate *atrophy of certain parts* of the brain after amputation of the limbs, and thus indirectly to prove the normal use of the parts which had atrophied from disuse. The use to which the monkey puts his tail, since it serves the purpose of an additional hand in some instances, renders the application of movements of that

<sup>1</sup> “Ophthalmology in its Relations to General Medicine,” “Lancet,” 1877.

<sup>2</sup> “Bilateral Deviations of the Eyes,” “Birmingham Med. Review,” 1875.

<sup>3</sup> *Op. cit.*

<sup>4</sup> *Op. cit.*

<sup>5</sup> “Blépharoptose cérébrale,” “Arch. Gén. de Méd.,” 1877.

<sup>6</sup> “Recherches cliniques sur les centres moteurs,” Paris, 1877.

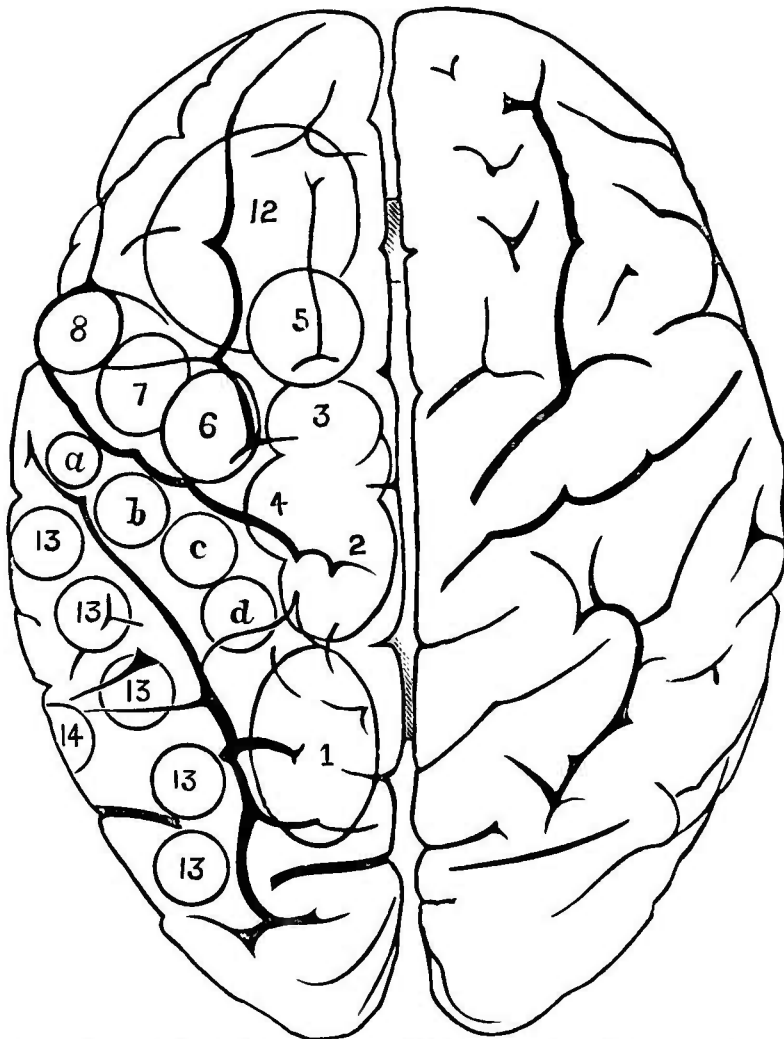

FIG. 16.—Upper view of the brain of man and the situation of areas of the cerebral convolutions. (After Ferrier.)

- 1 (on the postero-parietal [superior parietal] lobule), advance of the opposite hind-limb as in walking; 2, 3, 4 (around the upper extremity of the fissure of Rolando), complex movements of the opposite leg and arm, and of the trunk, as in swimming; *a*, *b*, *c*, *d* (on the postero-parietal [posterior central] convolution), individual and combined movements of the fingers and wrist of the opposite hand; prehensile movements; 5 (at the posterior extremity of the superior frontal convolution), extension forward of the opposite arm and hand; 6 (on the upper part of the antero-parietal or ascending frontal [anterior central] convolution), supination and flexion of the opposite forearm; 7 (on the median portion of the same convolution), retraction and elevation of the opposite angle of the mouth by means of the zygomatic muscles; 8 (lower down on the same convolution), elevation of the ala nasi and upper lip with depression of the lower lip, on the opposite side; 9, 10 (at the inferior extremity of the same convolution, Broca's convolution), opening of the mouth with 9, protrusion, and 10, retraction of the tongue—region of aphasia, bilateral action; 11 (between 10 and the inferior extremity of the postero-parietal convolution), retraction of the opposite angle of the mouth, the head turned slightly to one side; 12 (on the posterior portions of the superior and middle frontal convolutions), the eyes open widely, the pupils dilate, and the head and eyes turn toward the opposite side; 13, 13 (on the supra-marginal lobule and angular gyrus), the eyes move toward the opposite side with an upward 13, or downward 13; deviation—the pupils generally contracted (center of vision); 14 (of the infra-marginal, or superior [first] temporo-sphenoidal convolution), pricking of the opposite ear, the head and eyes turn to the opposite side, and the pupils dilate largely (center of hearing). Ferrier, moreover, places the centers of taste and smell at the extremity of the temporo-sphenoidal lobe, and that of touch in the gyrus uncinatus and hippocampus major.

organ to those of man a matter of apparent difficulty, and the center of motion for the tail of the monkey can hardly be applied to the brain of man without bringing comparative anatomy into prominence.

Paralysis of the leg, when dependent solely upon cerebral lesions, is seldom separated from a similar condition of the upper extremity, although a few rare cases of that character are on record; but the rule of Lucas Championnière may be considered as approximately correct, viz., that, to expose the center of motion for the muscles of the leg, it is necessary to trephine over the *upper extremity* of the *fissure of Rolando*.<sup>1</sup>

The centers of motion for the muscles of the *different regions* of the *upper extremity* occupy a much larger space upon the surface of the cerebrum than those of the lower extremity, as might have been expected when we consider the amount of intelligence which the hand exhibits.<sup>2</sup> Ferrier has pointed out certain motor areas for the various movements of extension, adduction and retraction, supination and flexion, and centers for the actions of the wrist and finger muscles.<sup>3</sup>

The close proximity of those centers which control the *facial* and *oral muscles* to the centers governing the motions of the hand possibly explains why movements of retraction of the mouth occur when the hand is brought into powerful action; and also the fact that paralysis of certain groups of muscles situated in the upper extremity are commonly associated with some form of facial paralysis.

From a careful analysis of cases where paralysis of the upper extremity was confined to certain sets of muscles, the results seem to point to the *ascending parietal* and the *upper*

<sup>1</sup> For the surgical guide to locate the situation of that fissure upon the exterior surface of the skull of a living subject, the reader is referred to a subsequent page of this chapter.

<sup>2</sup> Sir Charles Bell, "The Human Hand."

<sup>3</sup> In pages 39 and 41 of this volume, the centers of Ferrier are shown in a diagrammatic cut, and the special action of each given in the descriptive text which accompanies it.

portion of the *ascending frontal convolutions* of the cerebrum, as the probable seat of disease; and lesions of the *ascending parietal* convolution are found, both by experimental research and by pathological deduction, to *affect the hand* in particular. In further support of this statement, the results of the examination of the brains of persons who had suffered amputation of the hand,<sup>1</sup> or who had been characterized by a congenital absence of that member,<sup>2</sup> show an atrophy of the part designated by the experiments of Ferrier as the motor center for its movements.

The motor centers of the *facial muscles* occupy a region in close proximity to those of the arm and hand; and it is an exception to the general rule to observe paralysis confined exclusively to the face, since the muscles of some part of the upper extremity are generally affected simultaneously. It may be also noticed, with some degree of practical interest, that *aphasia* is a common associate of either of these types of localized paralysis, since the center of Broca is liable to be also involved from its close relation to both the centers of the face, arm, and hand.<sup>3</sup> It is considered by some authorities that the absence of aphasia, in cases where the muscles of the face, arm, or hand are paralyzed, is probably confined to lesions affecting only the *right side* of the cerebrum.

The lesions in which aphasia exists have been considered somewhat at length in previous pages of this chapter, but the fact that most of the clinical cases recorded have failed thus far to overthrow the discovery of Broca<sup>4</sup> seems to place it upon a footing above that of mere empirical generalization. Cases have been reported where aphasia has been the result of fracture of the left side of the skull in the region of the frontal lobes,<sup>5</sup> and also where recovery of the power of speech fol-

<sup>1</sup> Reported by Bourdon, "Centres moteurs des membres." Paris, 1877.

<sup>2</sup> Gowers, article in "Brain," 1878.

<sup>3</sup> See the relation of the facial centers, Nos. 7, 8, 11, to those of the arm and hand, Nos. 4, 5, 6, *a*, *b*, *c*, *d*, and to the oro-lingual centers, Nos. 9, 10, in Fig. 15 of this volume.

<sup>4</sup> Some late observations apparently point to other centers, as associated with speech, besides that of Broca.

<sup>5</sup> Mac Cormac, "Brain," 1877.

lowed the operation of trephining,<sup>1</sup> but it occurs most frequently as the result of embolic obstruction of the middle cerebral artery or of some of its branches.<sup>2</sup>

*Diagnosis of Cortical Motor Paralysis.*—The effects of lesions which involve the *corpus striatum* of either side, or the *anterior two thirds* of the *internal capsule* of the cerebrum, differ but little from those of lesions which are confined to the motor area of the cerebral convolutions, since the fibers which are affected in either case are the same.<sup>3</sup>

After the effects of the shock of the attack have passed away, the muscles which are paralyzed are usually those which are the most completely under the control of *volition*; thus the lower muscles of the face are more affected than those upon the forehead or of the eyelids, since the lower facial muscles are by far the most voluntary; the muscles of the hand are very markedly affected, even more than those of the arm; and the muscles of the upper extremity more than those of the lower.<sup>4</sup>

No evidence of impairment of *sensation* can be discovered, provided that the posterior third of the internal capsule of the cerebrum has escaped injury. The nutrition of the paralyzed muscles is apparently normal, and their electric contractility is not impaired.

A tendency toward *rigidity* of the paralyzed muscles develops, later on in the disease, which has been variously explained by some authors (Charcot, Bastian, and Bouchard) as the result of a *progressive sclerosis*, which descends along the motor tract of the pons Varolii, crus cerebri, medulla, and the spinal cord; while the researches of Hughlings-Jackson<sup>5</sup>

<sup>1</sup> Terrillon and Proust, "Acad. de Médecine," 1876.

<sup>2</sup> See researches of Meissner, Charcot, Vulpian, Seguin, Bertin, and others.

<sup>3</sup> Ferrier, *op. cit.* The reader is referred to Fig. 8 of this volume, in explanation of this statement.

<sup>4</sup> Pathological anatomy (recent cases) demonstrates: 1, that destructive lesions of the motor regions of the cortex (and of the para-central lobule) produce descending degeneration throughout the direct cerebral motor tract, extending into the lateral columns of the spinal cord; and 2, that there is a remarkable correspondence between certain localized spasmodic and paralytic symptoms observed during life and lesions irritating or destroying certain definite spots in the motor zone of the cortex.

<sup>5</sup> "Medical Examiner," April, 1877.



warrants him in discarding this explanation and attributing it to an unimpeded *cerebellar influence*, which is no longer controlled by the cerebrum. Both of these hypotheses are, however, discarded by Duret,<sup>1</sup> who considers the rigidity to be the result of simple *reflex irritation*. It will in no way add to the practicability of the matter contained here to enter into the discussion of the relative demerits of these theories, since those interested in the subject will find Ferrier's work on the "Localization of Cerebral Disease" and many of the advanced works upon the pathology of diseases of the nervous system to contain all the desired information.

One of the most valuable signs of paralysis dependent upon a lesion of the cortex is the fact that the condition is not one of complete hemiplegia, but rather of *monoplegia*, in which special groups of muscles only are deprived of voluntary motion: thus, the arm and leg may be affected together; again, the arm, hand, and face; the arm alone; the leg alone; certain movements only of either extremity; and all other possible combinations. Paralysis due to lesions of the cortex may often be transitory, if the lesion be slight and superficial; or it may be permanent, if deep and impinging upon the medulla. It is, furthermore, frequently associated with *rigidity* in its *early stages*, which is a rare occurrence in central cerebral disease.

In attacks of paralysis due to suddenly developed lesions of the cortex, *consciousness* is less frequently lost than in similar lesions of the central ganglia, and *pain* of a local character within the head is often either complained of by the patient spontaneously with the attack, or it may be sometimes elicited by percussion over the seat of the exciting lesion. The loss of consciousness which generally accompanies any sudden lesion of the central ganglia is explained by Duret<sup>2</sup> as due to a *rapid displacement* of the *cerebro-spinal fluid*, which in turn creates a general disturbance of the cir-

<sup>1</sup> "Brain," Part I, 1877.

<sup>2</sup> "Traumatismes cérébraux," Thèse, 1878; "Archiv. de Physiologie," 1875.

culuation of the cerebrum, since this fluid serves to establish a uniformity of pressure throughout the brain.

Ferrier<sup>1</sup> thus briefly summarizes the results of clinical observation bearing upon the diagnosis of paralysis dependent upon destructive lesions of the cortex: "While we can not be quite certain of the position or extent of a cortical lesion causing a sudden and complete hemiplegia, we may take a *monoplegia* of the leg, or of the arm and leg, as an indication of a lesion of the upper extremity of the ascending convolutions close to the longitudinal fissure; *brachial monoplegia*, as a sign of a lesion in the upper part of the ascending frontal convolution, or, if the paralysis *affect the hand* more particularly, of the ascending parietal convolution; *brachio-facial monoplegia*, as indicating a lesion of the mid-fronto-parietal region; while *facial* and *lingual monoplegia*, or this combined with aphasia, indicates a lesion of the lower part of the ascending frontal convolution where the third frontal joins with it."<sup>2</sup>

*Irritative Lesions of the Motor Area.*—It is a well-recognized fact in clinical experience that certain symptoms, which are chiefly of a convulsive type, are dependent upon conditions which create simply *irritation* of certain portions of the cerebrum, without any actual destruction of the gray or white matter. Among the various conditions which are especially liable to produce such local irritation may be mentioned syphilitic meningo-encephalitis, simple inflammation of the same character, deposit of tubercle, superficial cysts or tumors of a more solid character, spiculæ of bone, cicatrices from wounds of previous date, suppuration from caries and necrosis, etc.

In the year 1867,<sup>3</sup> and still later, in the year 1871,<sup>4</sup> the general statement by which the clinical diagnosis of the situation of irritative lesions of the cerebrum might be assisted was

<sup>1</sup> *Op. cit.*

<sup>2</sup> The plate showing the motor centers will tend to explain these deductions. See page 39 of this volume.

<sup>3</sup> "St. Bartholomew's Hospital Reports."

<sup>4</sup> "Medico-Chir. Trans."

advanced by Callender, "that convulsive attacks were most commonly associated with superficial lesions of the cortex situated in the immediate vicinity of the middle meningeal artery." Ferrier, however, concludes, as the result of his extensive facilities for observation, that, while this may be useful as a general rule, still *any portion* of the cortex of the hemisphere may result in convulsions of the opposite side of the body, and he adds the statement that the seat of an irritative lesion can be less accurately determined than one of a destructive character, owing to the difficulty of determining the extent of the zone in which vital irritation concentrates itself.

Hughlings-Jackson<sup>1</sup> has contributed much to the pathology of those conditions of the cortex, produced by irritation, which manifest themselves in the form of *convulsions*. So great a prominence did syphilis have as one of the exciting causes of such irritation that the term "Jacksonian epilepsy" is now often used as synonymous with the convulsions met with in that disease. The theory which this author advances to explain these convulsive attacks is as follows: That irritation of the cortex tends toward an abnormal accumulation of nervous energy, so that the affected part is under a state of high tension, and, under certain conditions, this irritated portion discharges itself in a sudden and explosive manner, thus producing a subsequent exhaustion of its powers; hence a convulsion, and often some type of monoplegia following it.

The convulsions dependent upon irritation of the cortex may assume all of the different varieties produced by destructive lesions of the motor area, and may even result in paralysis; thus the leg may alone be affected with spasm, the arm alone, the arm and hand together, and the face alone, or in connection with the upper extremity.

It may often assist in the localization of a lesion, which is creating the irritation of the cortex, to note carefully the muscles affected at the onset of the convulsion, since they may enable the observer, through a knowledge of the motor centers, to trace the seat of the region within the cortex which

<sup>1</sup> *Op. cit.* Also see "Medical Times and Gazette," 1875.

first exhibited a tendency to explosive discharge of its nervous energy.

#### THE SENSORY REGIONS OF THE CEREBRUM.

The temporo-sphenoidal and occipital lobes of the cerebrum are now accepted by most authors as the only portions which can appreciate the perception of *sensory impressions*. This fact seems to be demonstrated not only by experimental investigation upon animals, but also by clinical observation, with as great a degree of certainty as previous facts which have been mentioned regarding the function of the frontal region and the motor area.

It has been determined, with some approach to positiveness of statement, that the *posterior fibers of the crus* are the principal means of transmission of sensory impressions from the periphery of the body to the cerebrum, and the researches of Meynert have done much to demonstrate that these fibers are connected with the portions of the cortex which have been designated as the regions chiefly associated with sensory perception.

Duret,<sup>1</sup> Veyssièrè,<sup>2</sup> and Raymond have shown by experiment that, when that part of the internal capsule which is situated between the *lenticular nucleus* and the *optic thalamus* is divided, a loss of sensation is experienced in the opposite side of the body, but that, in some instances, some degree of motor paralysis is also produced. On the other hand, these same observers have found that section of the anterior two thirds of the internal capsule produces a distinct motor paralysis, with no effect upon the function of sensory perception of the parts paralyzed, save in a few instances, where such a result of a fleeting character was detected.

That these deductions are fully sustained by clinical facts, as far as the motor nerves are concerned, the statements of preceding pages seem to clearly prove, and the collected cases

<sup>1</sup> *Op. cit.*

<sup>2</sup> "Sur l'hémianesthésie de cause cérébrale," 1874.

reported by Charcot,<sup>1</sup> Pitres,<sup>2</sup> Türck,<sup>3</sup> and others, present a large mass of evidence to warrant the conclusion that lesions of the posterior part of the internal capsule are indicated by hemi-anæsthesia on the side of the body opposite to the lesion. In such cases, *tactile sensation is destroyed to the median line* not only in the trunk, but also upon the face; pain and the sensation of heat are likewise abolished; but the contractility of muscles under the electric current is not impaired or lost. If we examine the mucous membranes of the eye, nose, or mouth, the same condition of destroyed sensibility will be detected, but the viscera remain sensitive. Furthermore, taste, smell, and hearing are usually rendered deficient, and, in some cases, are entirely abolished, on the side opposite to the lesion; and the special sense of sight is affected in a variety of ways, which will be described in detail.

In the admirable work of Charcot,<sup>4</sup> a diagram is given to illustrate the effect of pressure upon the optic tract, the commissure, and the optic nerve itself, which I shall use in the discussion of the value of the optic nerve as a guide in diagnosis later in this course;<sup>5</sup> but the clinical facts afforded by lesions within the internal capsule fail to support similar results as the effect of intra-cerebral pressure. Thus, in lesions of the internal capsule, blindness of the lateral half of both retinæ (*hemianopsia*), as one would expect to find, does not exist; but, on the contrary, a condition of *amblyopia* results, which is characterized by a marked contraction of the field of vision, and especially so as regards the perception of color. By consulting the diagram given you in the description of the optic nerve,<sup>6</sup> you will perceive that the field for blue tints is the largest, and that red is next in point of size, while

<sup>1</sup> "Leçons sur les maladies du système nerveux."

<sup>2</sup> "Lésions du Centre Ovale."

<sup>3</sup> See Grasset, "Localizations dans les maladies cérébrales," 1878.

<sup>4</sup> *Op. cit.*

<sup>5</sup> The reader is referred to the diagrammatic cut and its descriptive text in the lecture upon the optic nerve.

<sup>6</sup> See page of this volume containing a diagram by Hirschberg.

green comes last.<sup>1</sup> Now, in lesions of the internal capsule, the perception of these colors is impaired in the relative proportion of the size of the field, and thus green may be entirely lost, while the vision of red or blue may still remain.

It has been shown by Landolt,<sup>2</sup> who has done much to develop this special field of investigation, that the impairment of vision from intra-cerebral causes is not altogether confined to one side, but that the eye upon the same side as the lesion is somewhat affected, and rendered partially anæsthetic.

If we examine the eyes so affected, we can not discover by the ophthalmoscope any organic disease or evidences of degeneration of either the optic nerve or the retina, provided that the examination is made early, before any late results of the blind condition of the eye manifest themselves as the effect of disuse.<sup>3</sup>

As has been before stated, the condition of amblyopia and the absence of hemianopsia are in opposition to what the effects of pressure upon the optic tracts would seem to suggest, but we still have a clinical fact to explain, viz., that hemianopsia does sometimes occur with attacks of hemiplegia. Ferrier states positively that, in such cases as these, we may conclude that the lesion must be either situated below the cerebral cortex, or exert its influence below the cortex, in case it be contained within it. The angular gyrus,<sup>4</sup> which is now considered as the probable center of vision, does not seem to exert any influence upon the motor apparatus, as is shown by its destruction in animals.

The OCCIPITAL LOBES of the cerebrum have been stated to be properly included among the sensory regions of the cortex. Experiments of section, or even of complete removal of these lobes of one or both sides, however, fail to show any effect

<sup>1</sup> Violet has a still smaller field, but it is not shown upon the chart.

<sup>2</sup> "La France Médicale," 1877.

<sup>3</sup> Any inter-cranial lesion which acts in such a way as to *increase the intra-cranial pressure* may produce (in addition to other symptoms) the condition known as "choked disk," or a neuro-retinitis.

<sup>4</sup> The reader is referred to the lecture on the optic nerve for further information upon this point.

upon sensory or motor functions. So negative, indeed, are these results that no disturbance of taste, hearing, touch, smell, or sight<sup>1</sup> has been positively produced. It is from the absence of positive experimental deduction as to these lobes that the distribution of the decussating fibers of the *optic tracts* to the occipital lobes may be yet considered as questionable, although such an anatomical distribution is stated, by many late authors,<sup>2</sup> to be capable of verification.

Certain clinical facts, however, seem to warrant the belief that the occipital lobes are associated with more apparent *mental derangement* than the frontal or temporo-sphenoidal lobes, in case they be the seat of disease, and the conclusion of Ferrier<sup>3</sup> is thus stated, as an hypothesis: "The occipital lobes are specially related to the visceral sensibilities, and are the anatomical sub-strata of the correlative feelings which form a large portion of our personality and subjectivity." It is claimed by Hughlings-Jackson that irritative lesions of the occipital lobes give rise to *colored perception* of objects and other ocular spectra, and he further states that such evidences of defective perception are more common when the lesion affects the right side.

The TEMPORO-SPHENOIDAL LOBES are situated between the motor area, in front, and the occipital lobe, behind. The following deductions have been drawn, by experimental research, as to the special functions of this lobe and some of the adjoining convolutions, which will require separate consideration:

The apparent connection of this region with the special sense of *vision* has been noticed by Hitzig, Goltz, and McKendrick, the two former of whom confined their experiments to the dog species, while the latter operated exclusively upon pigeons. Ferrier,<sup>4</sup> however, from a belief that other functions could be demonstrated as pertaining to this locality, and from

<sup>1</sup> Munk claims to have positively proved an association of the occipital lobe with vision, but his experiments have not, as yet, been fully substantiated.

<sup>2</sup> Researches of Ferrier, Yeo, Dalton, and others.

<sup>3</sup> "Localization of Cerebral Disease."

<sup>4</sup> *Op. cit.*, Ferrier and Yeo, "Brain," 1880; Exner, "Brain," October, 1880.

disbelief in the method pursued by Goltz,<sup>1</sup> as adapted to the requirements of experimental research concerning the functions of limited areas of the cortex, made a series of experiments upon the brains of monkeys, and claims to have established some new points of physiological interest, and, possibly, of practical value in cerebral localization.

The conclusions which were drawn as the results of the labors of this learned and original investigator may be thus summarized :

1. In the *angular gyrus*<sup>2</sup> is situated a center, which causes, on electric irritation, certain *movements of the eyes, pupils, and head*, but whose destruction creates no evidence of motor paralysis in the muscles of either the eye, its lids, or the pupil. Unilateral destruction, however, of this center causes blindness of the opposite eye, which proves but temporary ; while the destruction of *both sides* causes a *permanent loss of sight* in both eyes.<sup>3</sup> It thus appears that the center of either side is, to some extent, connected with both eyes.

2. In the *superior temporo-sphenoidal convolution*<sup>4</sup> is found to exist a center which, under galvanic stimulation, creates a twitching of the opposite ear and a *modification in hearing* of the opposite side, but which it was found difficult to fully ascertain on account of the animal not being able to exhibit appreciation of modification of that special sense. As in the preceding center, destruction of this convolution, upon one side, caused some abnormality of hearing ; and, when *both sides were destroyed*, the animal became *totally deaf*, but no motor paralysis could be discovered in either case.

3. In the *lower extremity* of the lobe previously designated, a center was found which seemed to exert an influence upon the *special sense of smell*, and also motions of the nos-

<sup>1</sup> That of trephining over the spot selected for investigation, and washing away the brain by a forcible stream of water.

<sup>2</sup> Regions marked 13 in Fig. 15 of this volume.

<sup>3</sup> The experiments of Munk, Luciani, Tamburini, Ferrier, Yeo, Dalton, and others, upon these centers leave the field, as yet, a matter for further investigation.

<sup>4</sup> See diagrammatic cut on page 39 of this volume ; regions marked 14.



tril and head which indicated excitation of that sense. In the regions adjacent to this convolution the special *sense of taste* became affected when destroyed; and, when the convolution and the adjacent region were destroyed, upon both sides, *taste and smell were utterly lost*. In regard also to these two centers, unilateral destruction created the most marked effects upon the side opposite to the lesion, while a bilateral destruction abolished the sense altogether.

4. In the *region of the hippocampus* some evidence was given of the control over *tactile sensation*, but the situation

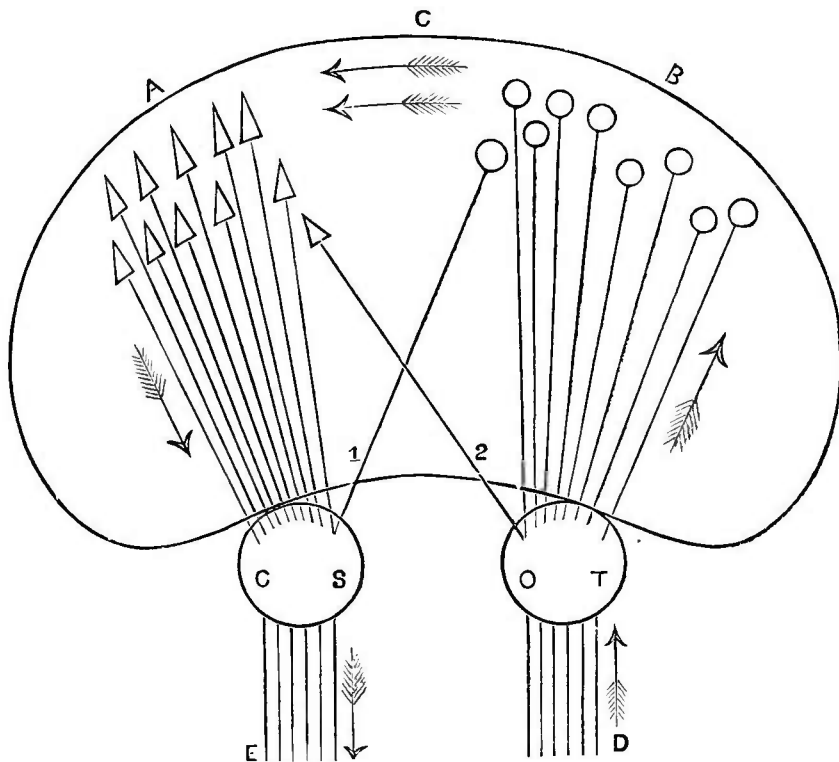

FIG. 17.—A diagram illustrating the course of nerve impulses in the cerebrum. (After Dodds.)

A, the motor regions of the cerebral cortex, represented by arrow-heads; B, the sensory regions of the cerebral cortex, represented by circles; C, commissural fibers, connecting the two regions of the cortex (probable, but not positively demonstrated); D, sensory nerve fibers, the arrow showing the *centripetal* direction of the impulse; E, motor nerve fibers, the arrow showing the *centrifugal* direction of the impulse; C. S., "corpus striatum" (the probable motor ganglion at the base of the cerebrum); O. T., "optic thalamus" (the probable sensory ganglion at the base of the cerebrum); 1, a few sensory fibers, possibly connected with the "corpus striatum"; 2, a few motor fibers, possibly connected with the "optic thalamus."

of the part rendered experiment upon it difficult, and somewhat less positive than those upon the areas previously discussed.

It is to be regretted that the conclusions of this author as to the situation of these special centers in the sensory regions of the cerebrum should not be as positively sustained by clinical and pathological facts as were the conclusions drawn from experimental research upon the motor area of the brain of the monkey tribe. Ferrier endeavors to explain the discrepancy between the facts obtained by experiment and those afforded by disease of the same regions in the human brain, by the hypothesis that the *special senses* may be governed by a *bilateral* rather than a unilateral impulse, as the experimental facts pertaining to the special senses of sight and hearing seem to warrant, and this has not, as yet, been disproved, since all of the cases recorded have been of a unilateral character.

To what extent these physiological subdivisions of the sensory area of the cerebrum may be regarded as of practical utility in diagnosis can hardly be determined, as the field is still a new one, and the collection of clinical and pathological records is insufficient for a basis of positive deduction.

#### THE CORPUS STRIATUM AND OPTIC THALAMUS.

These two bodies, which are called the "basal ganglia" of each cerebral hemisphere, are undoubtedly a means of communication between the gray matter of the convolutions and the fibers of the crura cerebri. While it can not be denied that some of the fibers of the internal capsule are in no way connected with these ganglia, and that a portion of the fibers which pass through them on the way to the convolutions are apparently independent of the nerve cells of these ganglia, still the greater proportion of the *peduncular fibers* of the cerebrum are undoubtedly *indirectly* connected with the gray matter of the convolutions, being intimately associated with the nerve cells of whichever of the basal ganglia they are obliged to pass through, in order to reach the exterior portions of the hemispheres.

It is thus affirmed, by many of our later physiologists, that these ganglia act in the capacity of *middle-men* between the gray matter of the convolutions and the rest of the component parts of the brain, and that they exercise an important influence in mediating between the psychological operations of the cortex and the moto-sensory functions of the remaining parts.

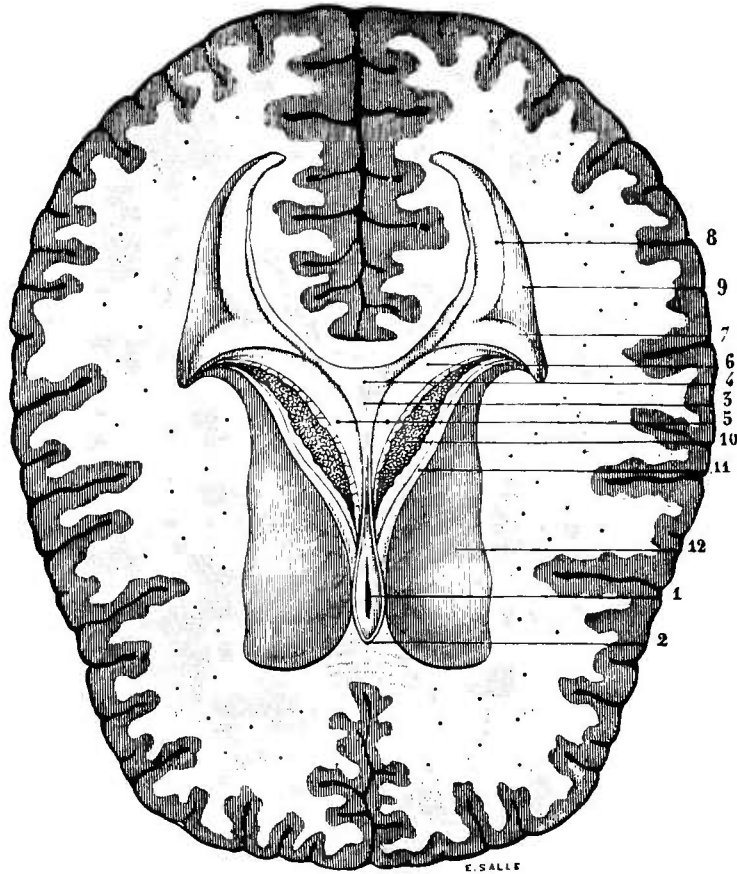

FIG. 18.—*Corpora striata.* (Sappey.)

- 1, fifth ventricle; 2, the two laminae of the septum lucidum meeting in front of the fifth ventricle; 3, hippocampus minor; 4, posterior portion of the corpus callosum; 5, middle portion of the fornix; 6, posterior pillar of the fornix; 7, hippocampus major; 8, eminentia collateralis; 9, lateral portions of the fornix; 10, choroid plexus; 11, tania semicircularis; 12, corpus striatum.

From the statement in previous lectures of the experimental and clinical deductions as to the various portions of the cortex, we may be able now to use with profit the *two axioms* which Foster,<sup>1</sup> in his work upon physiology, lays down as to the general plan of action of the brain in all its different parts. Thus, he says: “The preceding discussions enable us to lay down two broad propositions:

<sup>1</sup> Mich. Foster, “A Text-Book of Physiology.” London, 1878.

“1. The functions of the cerebral convolutions are *eminently psychical* in nature ; these parts intervene only in those operations of the nervous system in which an *intelligent consciousness* and *volition* play a part.

“2. The hinder parts of the brain, viz., the corpora quadrigemina, crura cerebri, pons Varolii, cerebellum, and medulla oblongata, are capable by themselves of carrying into execution *complex movements*, the coördination of which implies very considerable elaboration of afferent impulses ; and they can, in the case of animals, even do this with the total absence of the cerebral hemispheres, corpora striata, and optic thalami.”

The hypothesis, which was long since advanced by Carpenter<sup>1</sup> and also by Todd,<sup>2</sup> that the corpus striatum is called into action in the downward transmission of *motor impulses* to the opposite side of the body, and that the optic thalamus was the center of elaboration and transmission upward of *sensory impressions*, seems to be accepted as proven by some authors, while others are inclined to regard it, in the light of imperfect evidence, as a pleasing but speculative theory. The distribution of the fibers of the crus cerebri certainly points strongly to the corpus striatum as a *motor* ganglion, and to the optic thalamus as one destined to preside over *sensory* impulses.

The results of experimental investigation as to the corpora striata<sup>3</sup> can hardly be said to warrant any positive deductions. In some instances, the entire removal of these ganglia resulted in no loss of either sensation or motion, although it is a well-recognized clinical fact that hæmorrhage into this ganglion causes hemiplegia of the opposite side.<sup>4</sup> It would seem also that convulsions are more frequently produced by lesions confined to the corpora striata than when affecting the optic tha-

<sup>1</sup> W. B. Carpenter, “Principles of Human Physiology.”

<sup>2</sup> Todd and Bowman, “Physiological Anatomy.”

<sup>3</sup> The corpus striatum of each hemisphere taken collectively ; hence the plural termination.

<sup>4</sup> Probably the pressure created upon the anterior part of the *internal capsule* explains these phenomena. (See Fig. 8.)

lami, and these convulsive movements are generally crossed, like the paralysis of motion, in case of hæmorrhage. Both Ferrer<sup>1</sup> and Burdon-Sanderson<sup>2</sup> found that galvanic stimulation of the corpus striatum could be made to produce convulsive movements, and occasionally a condition of complete *pleurosthotonos* of the opposite side.

The two portions of the corpus striatum which are now recognized, viz., the ventricular portion<sup>3</sup> and the lenticular nucleus, have both been the subject of special investigation by Nothnagel;<sup>4</sup> but, while neither seemed to be concerned in the perception of sensory impressions, nothing of a positive character as regards the functions of the two portions was proven, although the ventricular portion seemed to show less effect upon voluntary motion than the lenticular nucleus, when both sides were destroyed.

The optic thalami were once supposed to be the chief ganglia of vision, but that this is an error investigation seems to have partly proven. Longet<sup>5</sup> has succeeded in destroying them upon the two sides, and has been unable to note any impairment in vision or influence upon the movements of the pupil; but Lusanna and Lemoigne<sup>6</sup> state that blindness of the opposite eye followed destruction of the ganglion upon one side only.

Cases of cerebral hæmorrhage throw but little light upon the function of these ganglia, since the destruction of brain tissue is seldom, if ever, confined to these ganglia only, and, in those cases where its limits were nearly confined to this region, paralysis of sensation of the opposite half of the body has been noticed without actual loss of motion upon that side, although the movements may have been somewhat enfeebled.<sup>7</sup>

<sup>1</sup> "Functions of the Brain," New York, 1879.

<sup>2</sup> "Proc. Roy. Soc.," 1875.

<sup>3</sup> Another name for the "caudate nucleus" of the corpus striatum.

<sup>4</sup> Virchow's "Archiv," 1873. This observer used injections of chromic acid into the lenticular nucleus, and destroyed the caudate nucleus by means of a special instrument.

<sup>5</sup> "Traité de Physiologie."

<sup>6</sup> "Fisiologia del Centri Nervosi Encefalici," 1871.

<sup>7</sup> Brown-Séquard, "Archiv. de Physiol.," 1877.

## THE CORPORA QUADRIGEMINA.

The experiments of Adamük,<sup>1</sup> by which he endeavored to prove the existence of a center or a collection of centers in the nates, whose function was to control the movements of the eyeball, will be considered in connection with the motor oculi nerve.<sup>2</sup> They seem to be substantiated in great measure by Hensen, Voelkers, and Knoll; and that a center also exists in the nates which contracts the pupil is quite as positively ascertained. This arrangement is in accordance with the wise provisions of nature, since the movements of the eyeball and the pupil (which are constantly associated) are thus controlled by centers in close proximity to each other.

The experiments of Hensen,<sup>3</sup> and also of Voelkers,<sup>4</sup> seem to point to the *aqueduct of Sylvius*, which lies immediately underneath the tubercula quadrigemina, as the exact seat of these centers, since stimulation of the deep portions of the nates after section produces more uniform results than could be obtained before the deeper parts were exposed.

Destruction of either side, in the region of these ganglia, produces blindness of the opposite eye; but the animal can see, even after the cerebral hemispheres have been removed, in case the tubercula quadrigemina are left intact. This latter statement seems somewhat at variance with the results of experiments of Ferrier upon the *angular gyrus*, as given in a previous lecture of this course, in which vision was utterly lost when both sides were destroyed; but it only goes to show that the cerebral hemispheres are in some way connected with the tubercula quadrigemina in the perceptions gained by sight, since, when the hemispheres are removed, an apparently crude vision remains.

The sense of sight has a marked effect upon the coördina-

<sup>1</sup> "Cbl. med. Wiss.," 1870.

<sup>2</sup> See later pages of this volume.

<sup>3</sup> "Archiv. f. Ophthalmol.," 1878.

<sup>4</sup> *Ibid.*, 1878.

tion of movement,<sup>1</sup> and the discovery of Flourens,<sup>2</sup> that the removal of the tubercula quadrigemina created impairment of this power, sustains the belief that the ganglion of vision must be in some way associated either with the cerebellum, crura, or pons Varolii, in their effects upon coördination of muscular movements.

#### THE CRURA CEREBRI AND PONS VAROLII.

These parts form the larger portion of the meso-cephalon, and are abundantly supplied with gray matter, which seems to be mixed throughout its interior. We thus infer that these parts have some individual functions, in addition to being simply connecting commissures between the upper parts of the brain and spinal cord, but what these functions are it is difficult, at present, to say. Both of these regions are unquestionably connected in some way with the power of coördination of muscular movement, since section of either of them results in marked disorder of this function, and often in unnatural and forced movements.

The fact that some of the nerve fibers decussate in these regions seems proven by clinical evidence, since lesions of the pons Varolii often produce *paralysis of the facial nerve* upon the same side as the lesion, while the opposite side of the body is affected below the face.<sup>3</sup>

The facial nerve makes its exit from the side of the medulla oblongata; some of its roots of origin can be traced as far as the floor of the fourth ventricle, others come from the lower part of the medulla oblongata, and others descend from the

<sup>1</sup> This subject is quite fully discussed in connection with the optic nerve.

<sup>2</sup> "Recherches experimentales sur les propriétés et les fonctions du système nerveux," 1845.

<sup>3</sup> This class of paralysis, where certain cranial nerves are paralyzed on the same side as the existing lesion, while the body is rendered hemiplegic on the opposite side, is called "*crossed paralysis*" (the "*paralyse alterne*" of the French). It presents *several types* depending upon the cranial nerve affected; hence the so-called third nerve (motor oculi) and body type, the fifth nerve (trigeminus) and body type, the seventh nerve (facial) and body type. Professor Romberg of Berlin and Gubler of Paris have done much to elucidate the clear appreciation of this complex form of paralysis and the mechanism of its production.

upper border of the pons Varolii, where they probably decussate. Now, a lesion existing in a lateral half of the pons Varolii will, therefore, produce a paralysis of the corresponding facial nerve and of the opposite spinal nerves; whereas, if it occur above the point of decussation of the encephalic fibers, the paralysis will be on the opposite side for all parts of the

body. These facts are shown in the accompanying diagram (Fig. 19).

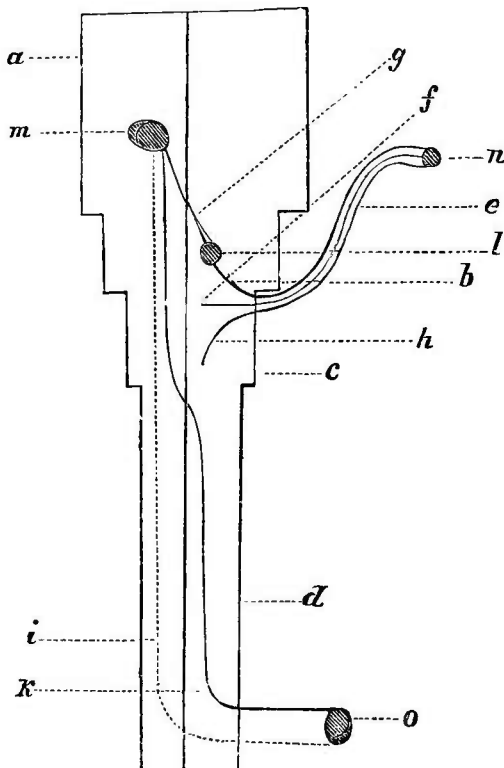

FIG. 19.—A diagram to illustrate the method of production of crossed paralysis. (After Hammond).<sup>1</sup>

*a*, the left hemisphere; *b*, right half of pons; *c*, right half of medulla oblongata; *d*, right half of spinal cord; *e*, right facial nerve; *f*, fiber of origin from nucleus in medulla oblongata; *g*, descending fiber decussating at upper border of pons; *h*, ascending fiber; *i*, sensory root of spinal nerve; *k*, motor root of sensory nerve; *l*, lesion in pons; *m*, lesion in left hemisphere; *n*, paralyzed part supplied by facial nerve; *o*, paralyzed part supplied by spinal nerve.

It is obvious, from a study of this diagram, that a lesion of one lateral half of the pons (at *l*) will cause paralysis of motion and of sensibility of the opposite side of the body generally, and of the corresponding side of the face; and that a lesion of the hemisphere (at *m*) will produce paralysis of the opposite side of the face and body.

As we might naturally expect from the direction of the fibers of the pons Varolii, this portion of the brain acts as a direct conductor of both motor and sensory impressions from and to the cerebrum; while the collections of gray matter within its substance prove it to possess some functions of its own which are independent of the stimulation of the cerebral cortex.

Without entering into the different experiments which have been made to determine the exact part which this portion

<sup>1</sup> Hammond, "Diseases of the Nervous System." New York, 1876.



of the meso-cephalon plays in the complex machinery of movement and sensation, it seems probable that the pons Varolii is capable of originating a stimulus which may give rise to voluntary motion without the aid of the hemispheres, and that it probably regulates those automatic movements which govern *station* and *progression*. The experiments of Vulpian<sup>1</sup> and Longet<sup>2</sup> also seem to prove that the *sensation of pain* is perceived by the pons Varolii even when the cerebrum and the basal ganglia are removed, which, when these portions are allowed to remain, are probably transmitted to the hemispheres as sensations, and are there remembered.

## THE CEREBELLUM.

There seems to be a greater contradiction between the deductions drawn from the results of experiment upon the cere-

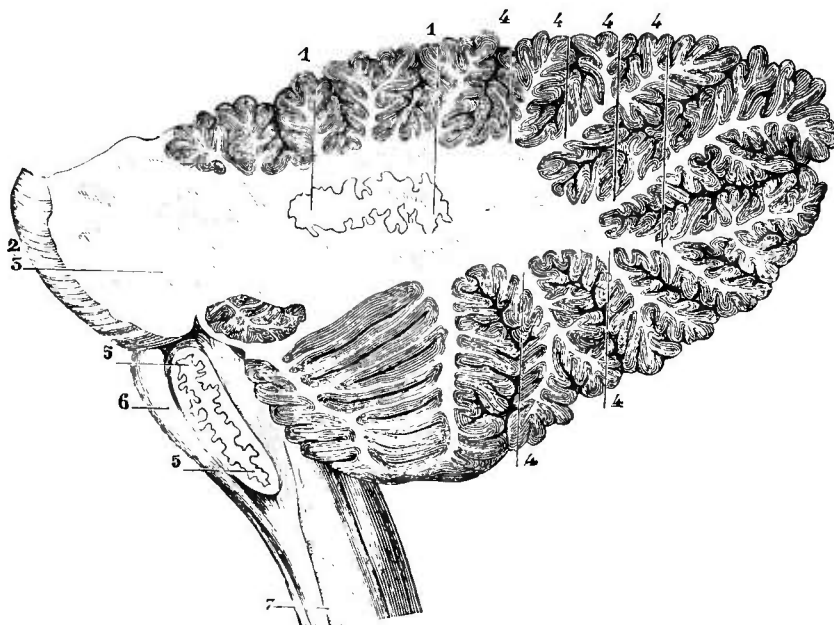

FIG. 20.—*Cerebellum and medulla oblongata.* (Hirschfeld.)

1, 1, corpus dentatum; 2, tuber annulare; 3, section of the middle peduncle; 4, 4, 4, 4, laminae forming the arbor vitae; 5, 5, olivary body of the medulla oblongata; 6, anterior pyramid of the medulla oblongata; 7, upper extremity of the spinal cord.

bellum and the statistics of well-reported pathological observation than exists with any of the other ganglia of the

<sup>1</sup> *Op. cit.*

<sup>2</sup> *Op. cit.*

encephalon, since, although the power of governing coördination of muscular movements has generally been attributed to it by most physiologists, cases are on record where the whole ganglion has been almost destroyed by disease in man, and still no marked effect upon coördination has been observed.

The experiments of Flourens,<sup>1</sup> Bouillaud,<sup>2</sup> Vulpian,<sup>3</sup> and others seem, however, to show that, while removal of any portion of the cerebellum produces interference with the coördinating power over the voluntary muscles, a *recovery* still takes place, after a lapse of time, without a regeneration of the severed portion; and this fact alone may assist us to explain how very large portions of the cerebellum may be gradually destroyed by disease and the remaining part acquire the power of performing the normal function of the entire ganglion. Thus Andral<sup>4</sup> reported some ninety cases of disease of the cerebellum, in all of which but one the symptoms were not so well marked as to support the theory of the coördinating function of that ganglion, but, in many of these cases, as proven by Flint,<sup>5</sup> the circumstances warranted no physiological deduction whatever, while in others the destruction was not more extensive than had frequently been made on animals and recovery of the coördinating power been perfectly regained.

There are certain facts which tend to show some connection between the semicircular canals of the ear and the cerebellum, and some authors have endeavored to prove that the effects of section of the cerebellum are due in great measure to a *vertigo* produced similar to that which exists in the so-called "Menière's malady," which is dependent upon the ear mechanism.<sup>6</sup> The experiments of Purkinje on the human cerebellum, by passing the electric current through the head from ear to ear, showed a marked type of vertigo to ensue; and an oscillation of the eyes, which perform all varieties of movement, was observed by Hitzig<sup>7</sup> in the same class of experiment.

<sup>1</sup> *Op. cit.*

<sup>2</sup> *Op. cit.*

<sup>3</sup> *Op. cit.*

<sup>4</sup> "Clinique Médicale." Discussed and quoted in full in the "Text-Book of Physiology," by A. Flint, Jr.

<sup>5</sup> A. Flint, Jr., "Text-Book of Physiology." New York, 1880.

<sup>6</sup> See lecture on the auditory nerve.

<sup>7</sup> *Op. cit.*

Numerous attempts have been made to connect the cerebellum with the sexual functions, but the results of later experiments seem to locate the center of the sexual appetite in the spinal cord, somewhere in the lumbar region.

Stimulation of the cerebellum has been observed to create peristaltic movements in the œsophagus and stomach, as shown by Budge,<sup>1</sup> and diabetes has been observed to follow galvanism of this ganglion, by Eckhard.<sup>2</sup> Some relation between the cerebellum and the intestinal tract seems to be further demonstrated by the researches of Schiff, who observed that after injuries to the peduncles of the cerebellum an inflammatory condition of the intestine followed, which was of so acute a type as to be accompanied with hæmorrhage.

The hypothesis of Mitchell, that the cerebellum is the storehouse for nervous force for use in emergencies, is plausible, from the remarkably numerous and intimate connections of this ganglion with other parts of the nervous system, but cannot, as yet, be considered as proven.

The cerebellum is remarkable for the numerous connections which exist between it and the other parts of the nervous system. Each hemisphere is connected with the caudate nucleus and the hemisphere of the cerebrum of the opposite side; also, by special fibers, with the substance of the pons Varolii and the deeper parts of the meso-cephalon (including its gray and white substance); again, with the medulla oblongata and the spinal cord; and, finally, the existence of commissural fibers connecting the hemispheres of the cerebellum is probable. The close relation which it bears (1), to the medulla, whose numerous centers are doubtless well known to you all; (2), to the corpora quadrigemina and its center governing the vaso-motor function, and having a possible effect upon convulsive movements; (3), to the "tegmentum cruris," the great sensory tract; and (4), possibly to the third, fourth, and eighth nerves,<sup>3</sup> which have been traced by some observers to this

<sup>1</sup> As quoted by Foster.

<sup>2</sup> Eckhard's "Beiträge," 1878.

<sup>3</sup> This source of origin is as yet undecided.

ganglion, certainly seem to point to some most important functions as located in this part of the brain, but at present little can be positively stated.

The intimate relation which this ganglion bears to these parts renders it a matter of extreme difficulty to discriminate, clinically, between the results of disease of the cerebellum and the effects of pressure created upon adjacent regions. When we consider how near the ganglia of vision, the points of origin of the third, fourth, and sixth nerves, and the various nuclei of the fourth ventricle, are to the cerebellum, we can understand why careful observers are loath to accept symptoms referable to the eye or ear as positive evidence of cerebellar disease, and why vomiting, so often present, may not be attributed with equal force to pressure exerted upon the medulla oblongata. In point of fact, we can only consider the symptom called "cerebellar ataxia" and the presence of pain in the occipital region as of positive value in the diagnosis of disease of this ganglion, and even these may often be absent.

When the loss or coördination of movement dependent upon disease of the cerebellum is well marked, a peculiarity of attitude in walking, called by some authors "titubation," is developed. The patient walks with the feet widely separated; the trunk is usually bent forward and sways constantly; while the hands and arms are used to preserve the equilibrium of the body. The absence of all spasmodic movement, of tremor, and of the want of harmony between antagonistic groups of muscles, as seen in true ataxia, tends to distinguish it from other forms of disease. The upper extremities are usually free from this imperfect coördination; closing of the eyes sometimes increases the ataxic symptoms, but often fails to affect them; the recumbent position seems to arrest all symptoms of incoördination; and the general condition closely resembles that of alcoholic intoxication. The recent researches of Nothnagel, in which he publishes the analysis of over two hundred and fifty cases, seem to point to the superior vermiform process as the region most liable to produce this type of

ataxia. He states that, if the patient be barefoot, the toes will be seen to be in active motion ; that the patient will bring the foot to the floor, sometimes on the heel and sometimes on the ball, irrespective of intention, thus giving an irregularity to the movements of that member ; that the body will sway to and fro ; and that the legs will be separated in order to afford additional security in the standing or walking position.

#### THE MEDULLA OBLONGATA.

This ganglion—the uppermost portion of the spinal cord—is the true *nerve center of animal life*, since immediate death follows severe injury to its substance. The fact that the seventh, eighth, ninth, tenth, eleventh, and twelfth nerves arise directly from this ganglion, and that some fibers from other of the remaining six cranial nerves can be traced to the cavity of the medulla—the fourth ventricle—serves to explain the importance of this special nerve center. In addition to the special influence of the medulla oblongata upon the nerves which arise from it, it contains most of the fibers which are distributed to the other parts of the encephalon, and thus it must transmit both the motor and sensory impulses, as they pass from and enter the cerebrum.

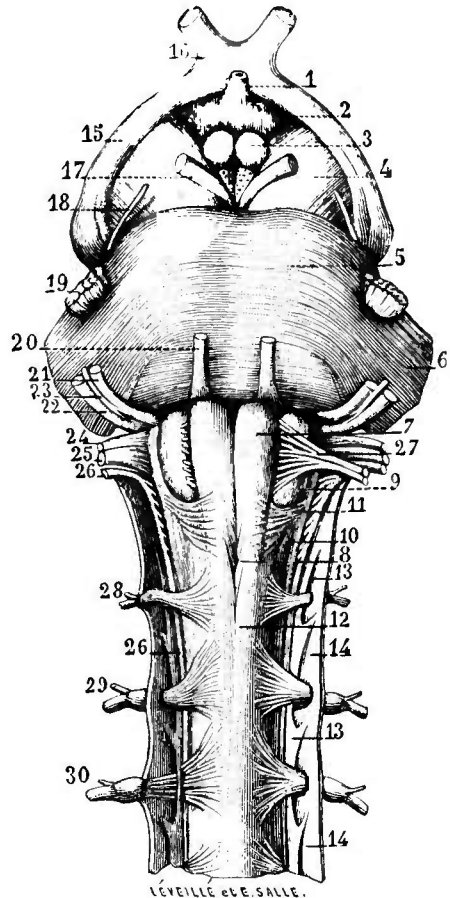

FIG. 21.—Anterior view of the medulla oblongata. (Sappey.)

- 1, infundibulum ; 2, tuber cinereum ;
- 3, corpora albicantia ; 4, cerebral peduncle ; 5, tuber annulare ; 6, origin of the middle peduncle of the cerebellum ; 7, anterior pyramids of the medulla oblongata ; 8, decussation of the anterior pyramids ; 9, olivary bodies ; 10, restiform bodies ; 11, arciform fibers ; 12, upper extremity of the spinal cord ; 13, ligamentum denticulatum ; 14, 14, dura mater of the cord ; 15, optic tracts ; 16, chiasm of the optic nerves ; 17, motor oculi communis ; 18, patheticus ; 19, fifth nerve ; 20, motor oculi externus ; 21, facial nerve ; 22, auditory nerve ; 23, nerve of Wrisberg ; 24, glosso-pharyngeal nerve ; 25, pneumogastric ; 26, 26, spinal accessory ; 27, sublingual nerve ; 28, 29, 30, cervical nerves.

The medulla is possessed of a large amount of *gray matter* within its interior, where it forms the lining of the cavity of the fourth ventricle; and it is in this gray matter that the action of the medulla, which is largely *reflex* in character, takes place. From the nerves which spring from its substance, we should expect that these reflex acts should be chiefly concerned in the movements of the facial muscles by means of the seventh nerve; with audition by means of the eighth; with deglutition by means of the ninth; with respiration through the pneumogastric or tenth nerve; with phonation and the action of the heart by means of the spinal accessory; and with lingual movements by means of the hypo-glossal.

Various collections of gray matter in the floor of the fourth ventricle have been described by Lockhart Clarke, who has connected them with special nerve roots; while experimental investigation has also determined certain special *physiological centers* to have their seat within the substance of the medulla oblongata. As the former centers may be found in almost all of the later works upon descriptive anatomy,<sup>1</sup> an enumeration only of the physiological centers will be given, since their presence adds much to the interest which pertains to the medulla as a reflex ganglion.

1. The *respiratory center*, which governs the respiratory acts, in response to sensory impressions transmitted to it by means of the pneumogastric nerve.

2. The *vaso-motor center*,<sup>2</sup> which seems to control the

<sup>1</sup> The *fourth cranial* nerve is said to arise from a nucleus on the outer side of the locus cœruleus. The *trigemini* (fifth cranial) nerve probably arises from two nuclei situated at the outer angle of the floor of the fourth ventricle; the more external or *sensory nucleus* being continuous with the gray tubercle of Rolando, while the internal or *motor nucleus* lies close to the sensory nucleus, but nearer the median line. In the upper half of the fourth ventricle, the *sixth* cranial nerve and *seventh* cranial nerve (facial) take their origin from distinct nuclei. The *auditory nerve* (eighth cranial) has two separate nuclei, as has the fifth cranial, called the *internal* and *external auditory nuclei*, which are situated below those of the trigemini nerve and above the nucleus for the glosso-pharyngeal nerve. Finally, in the lower half of the fourth ventricle, close to the postero-median fissure, are found separate nuclei of origin for the glosso-pharyngeal, pneumogastric, the accessory portion of the spinal accessory, and the hypo-glossal nerves.

<sup>2</sup> The upper limit of this center in the rabbit is placed by Owsjannikow (Ludwig's

caliber of the larger blood-vessels, by means of efferent impulses, transmitted chiefly through the splanchnic nerves, which affect the muscular coat of the vessels of the thorax, abdomen, and pelvis.

3. The *cardio-inhibitory center*, by which the heart is arrested in diastole, or held under control,<sup>1</sup> in response to sensory impressions carried to the medulla from other sources by means of sensory nerves.

4. The *center for deglutition*, which controls both the second and third stages of that act, or from the time when the bolus passes the isthmus of the fauces.

5. The *center for the movements of the œsophagus and the stomach*, with its allied center for the control of the mechanism of the *act of vomiting*.

6. The *diabetic center*,<sup>3</sup> which, when stimulated, produces a saccharine condition of the urine.

7. The *salivary center*,<sup>4</sup> which, upon excitation, tends to increase the flow of the saliva, and possibly, also, the pancreatic fluid and the other digestive juices.

“Arbeiten,” 1871) at about 2 mm. below the tubercula quadrigemina, and its lower limit at about 4 or 5 mm. above the calamus scriptorius. Clarke locates it near to the origin of the facial nerve, and claims that large multipolar cells can be detected in the vaso-motor area; while Dittmar (Ludwig’s “Arbeiten,” 1873) places it chiefly in the lateral columns, after the fibers have been given off to the decussating pyramids. Besides this vaso-motor center in the medulla oblongata, other parts of the spinal cord unquestionably exert a positive vaso-motor influence, causing constriction or dilatation of the blood-vessels.

<sup>1</sup> If the mesentery of a frog be exposed, and a slight tap be given it by the handle of the scalpel, the heart will at once cease to beat, but will soon resume its function. This experiment, coupled with many others of interest, seems to point definitely to the medulla as the seat of mediation between afferent sensory impulses and efferent inhibitory impulses upon the heart.

<sup>2</sup> This subject will be found discussed, at some length, in the pages devoted to the mechanism of deglutition, as well as the movements of the œsophagus.

<sup>3</sup> The diabetic center, as marked out by Eekhard, corresponds closely to that defined by Owsjannikow as the vaso-motor area. Pricking of this center in a well-fed rabbit will produce a considerable amount of sugar in the urine, within an hour or two following the experiment. This effect is poorly marked in animals whose livers have been deprived of glycogen by starvation.

<sup>4</sup> The flow of saliva is apparently a reflex act dependent upon afferent impulses perceived through the gustatory branch of the fifth cranial nerve, the efferent impulse being transmitted by means of the chorda tympani branch of the facial nerve. It is this function of the latter nerve that is considered by some physiologists as explanatory of the effect of the chorda upon taste. (See pages descriptive of the facial nerve and its branches.)

Finally, it is proven that the medulla oblongata in animals plays a part in the coördination of movement, and it may be considered probable that in man the same property is likewise possessed ; but it is, unfortunately, incapable of demonstration, as the death of the individual usually follows any traumatic lesion of this ganglion.

The clinical aspects of the medulla, its minute anatomy, and its physiological construction, will be more fully considered in connection with the spinal cord and cranial nerves.

#### THE SURGICAL BEARINGS OF CEREBRAL TOPOGRAPHY.

In the year 1861, Broca invented a scientific method of determining the relations of different parts of the cerebrum to the exterior of the skull, which consisted of driving pegs through the skulls of animals and of cadavers, holes having been previously bored through the bone in order to prevent fracture and injury to surrounding parts. The skull-cap was then removed with extreme care, and the convolutions which were wounded were thus determined. It was discovered by this observer that the *fissure of Rolando*, whose relation to the coronal suture was then unknown, lay obliquely, and that its upper extremity could be placed, with great accuracy in man, at a point situated *forty millimetres behind the coronal suture*. This fissure was particularly studied on account of its relation to the *motor region of the cortex*, and its exact bearing to the exterior of the skull was therefore of great importance. The same observer was also able to prove that the *external parieto-occipital fissure* of the cerebrum lay under the *lambdoid suture* of the cranium. In 1873, the experiments of Heftler and Bischoff were added to those of Broca, while Turner followed with his researches in 1874, and Féré in 1875. The drawings which Turner furnished were admirable in their way, but are, to my mind, hardly adapted to the purposes of the surgeon, since the guides which the bony prominences of the skull afford are not brought into such prominence as to be readily comprehended by the casual reader. If the surgeon is



to utilize the valuable researches of the investigators above named (and several most brilliant surgical operations have already been performed from the light which the newly acquired knowledge of the topography of the cerebrum has afforded), certain *bony prominences* of the skull must be designated, as of importance, as guides to the special convolutions and fissures of the brain. Now, there is one line which is easily drawn upon the head of the living subject (the alveolo-condyloid plane of Broca), upon which perpendicular lines may be described, intersecting certain bony points, which lines can be utilized as guides to parts whose situation is now positively known. This base line should be a straight one, and should intersect the tip of the mastoid process and the line of the cusps of the teeth of the upper jaw.<sup>1</sup>

This is the natural posture of the human skull, when the upper jaw is removed and the skull placed upon a table; hence it is a plane admirably adapted for the study of the guides (which will be given), upon the skeleton, in the office of each practitioner, previous to an operation. Furthermore, a skull can easily be painted upon its exterior so as to bring the lines, designated as important, into prominence, and so assist the surgeon in the review of those points which possess special value. The contribution of Féré is, to my mind, the best of all the authors named, since it presents the points most needed by the surgeon in a practical way; and the *résumé* of his guides is so tersely and clearly stated by my friend Professor Seguin that it would be useless to attempt to improve upon it. It will be perceived in the plate, introduced to make these guides more clear than a mere verbal description, that the line described, viz., the alveolo-condyloid plane of Broca, is used as a base line upon which to erect perpendiculars at distances which can be accurately measured upon it; and that these perpendicular lines inter-

<sup>1</sup> This author places the line as intersecting the *condyle of the occipital bone*; but, as this can not be felt in the living subject, and as it corresponds to the tip of the *mastoid process*, I have modified the guide so as to simplify its exact situation upon the exterior of the skull.

sect certain regions which, from facts previously recorded, are of the greatest importance. I quote the *résumé* of Seguin<sup>1</sup> upon this special department of cerebral localization :

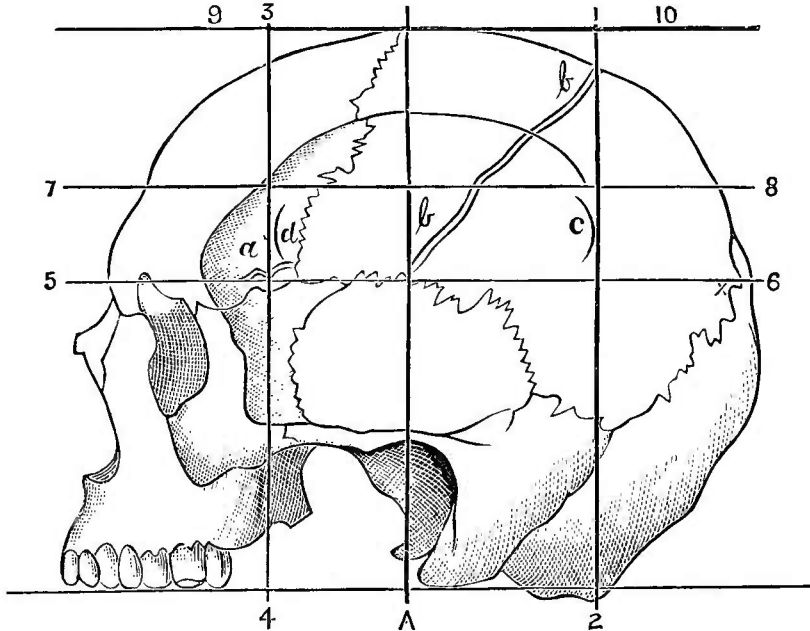

FIG. 22.—Outline of skull resting upon the alveolo-condyloid plane of Broca. (Modified from Topinard's "Anthropology" by Seguin.)

Vertical line  $\Lambda$ , or auriculo-bregmatic. Line 9-10, drawn parallel to the plane of Broca. Upon this line, at a distance of 45 mm. posterior to the bregma, a vertical line, 1-2, will pass through the upper (inner) end of the fissure of Rolando,  $b, b$ , and through the posterior extremity of the thalamus opticus ( $c$ ). A third vertical line, 3-4, drawn at 30 mm. forward of the bregma, will pass through the fold of the third frontal gyrus ( $a$ ), and through the head of the nucleus caudatus ( $d$ ). The horizontal line, 7-8, at 45 mm. below the bregma (scalp), indicates the upper limit of the central ganglia. The third horizontal line, 5-6, passing through the external angular process of the frontal bone and the occipito-parietal junction, approximately indicates the course of the fissure of Sylvius, and serves for measurements. At 18 or 20 mm. behind the external angular process on this line is the speech center of Broca; 5 to 8 mm. behind the intersection of 3-4 and 5-6 is the beginning of the fissure of Sylvius, and at 28 or 30 mm. behind this intersection is the lower end of the fissure of Rolando,  $b, b$ , placed a little too far back in the cut. At  $\times$  (near 6), near the median line, is the location of the occipito-parietal fissure.

“1. A vertical line ( $\Lambda$ ) drawn from the alveolo-condyloid plane, through the external auditory meatus upward, will pass through or very near to the bregma, or line of junction of the frontal and parietal bones at the vertex; it passes through the anterior (lower) extremity of the fissure of Rolando.

“2. If, from the upper end of this vertical line  $\Lambda$ , we measure a distance of 45 mm.<sup>2</sup> backward toward the occiput and

<sup>1</sup> "Medical Record," 1878.

<sup>2</sup> A millimetre is about one twenty-fifth of an inch.

draw a descending vertical line (1-2), we mark out the location of two most important parts of the cerebrum, viz., the posterior extremity of the fissure of Rolando [at *b*], and the posterior limit of the thalamus opticus in the hemisphere [at *c*].

“3. To conclude with the occipital end of the skull; if we can make out with the finger the lambdoid suture at the median line, we thus learn the situation of the subjacent occipito-parietal fissure, which separates the parietal and occipital lobes.

“4. The last vertical line worth noting is one drawn at a distance of 30 mm. forward of the auriculo-bregmatic line. This vertical line (3-4) will pass through the middle fold of the third frontal convolution (just forward of the speech center), and will also indicate the anterior limit of the central cerebral ganglia, viz., the head of the nucleus caudatus in the hemisphere [at *d*].

“5. The upper level of the central cerebral ganglia may be quite exactly indicated by an horizontal line drawn at a distance of 45 mm. below the surface of the scalp, at the bregma, (or 35 below the surface of the bare skull at the same point). This line (7-8) also runs across the middle regions of the motor district of the convolutions, containing centers for the face and upper extremities.

“6. The external angular process of the frontal bone, not difficult to define in the living subject, is the starting-point of another horizontal line (5-6), whose posterior extremity passes a little below the lambdoid suture. Upon this horizontal line we can, by measurement, determine the location of certain parts. Thus, at a distance of 18 or 20 mm. behind the external angular process, lies the folded part of the third frontal convolution (*a*). This point, in many heads, will correspond to the vertical line 3-4.

“7. The situation of the fissure of Sylvius may be approximately ascertained in the following manner: Its middle portion extends horizontally, almost under the upper part of the squamous suture, which in the living subject is to be found a little below the horizontal line 5-6. The anterior extremity or beginning of the fissure of Sylvius is a little below this hori-

zontal line, at a distance of some 5 to 8 mm. posterior to the intersection of 3-4 and 5-6, and consequently about 22 or 25 mm. anterior to the auriculo-bregmatic line A. Lastly, according to Turner, the parietal eminence almost always overlies the supra-marginal gyrus (P<sup>1</sup>, Fig. 23), consequently the posterior extremity of the fissure of Sylvius is likewise in this vicinity.

“8. The angular gyrus is to be found below and behind the parietal eminence, a little above the horizontal line drawn from the external angular process (5-6).

“9. The anterior (lower) end of the fissure of Rolando lies at a distance of 28 or 30 mm. behind the line 3-4, and a little above 5-6. It is, therefore, a few millimetres anterior to the vertical line A.”

With this plate as a guide, and with a thorough knowledge of the facts comprised in previous pages of this chapter, it is not out of the bounds of possibility to definitely locate the existence of lesions in certain portions of the human brain, to map out their situation upon the exterior of the skull, and to reach them with surgical means of relief, provided the case be one which would justify such a measure. When Broca has been successful in trephining directly over an abscess of the third frontal convolution, which was suspected, and when successful cases have been reported of trephining of the skull for fragments of the inner plate which were compressing the ascending gyri of the frontal and parietal lobes, thus causing paralysis, have we not every reason to hope that the day is coming when the rules governing this operation will be those based upon science rather than upon empiricism, and when the surgeon will owe his success to the researches of the physiologist and the labors of the pathologist?

There are certain suggestions, which may be thrown out in this connection, which are safe ones to follow in cases where the propriety of surgical relief is called into question. These may be stated in the form of propositions, which are of necessity based upon the contents of the previous lectures.

1. If the injury sustained, provided the case in question be one of a traumatic origin, be *situated over the motor area*

of the cortex, the presence of *anæsthesia* in combination with motor hemiplegia is a contraindication to attempts at surgical relief. This symptom (anæsthesia) probably indicates some injury to the posterior third of the internal capsule, or to the white substance of the hemispheres ; hence the lesion is probably too extensive to be relieved by trephining.

2. If the *sensory region* of the cortex be involved, and *paralysis* or *convulsive movements* occur, an operation is contraindicated ; since the lesion has either been so extensive as to extend to the motor area, or has torn or compressed the cerebrum at a point removed from the apparent seat of injury

3. The occurrence of *paralysis on the same side* as that upon which the injury was received is always a contraindication to any surgical procedure at the seat of injury, since it usually indicates some lesion of the opposite side, probably dependent upon transmitted force (*contre-coup*).

4. The *completeness of the paralysis* may be often taken as a guide to the amount of injury done to the cerebrum : if the paralysis be very profound, the chance of success from trephining is extremely small, since the injury has probably affected parts deeper than the cortex centers.

5. The appearance of *paralysis of any of the special nerves of the cranium*, or the development of the symptoms due to lesions of the base of the brain or of the basal ganglia, such as the Cheyne-Stokes respiration,<sup>1</sup> choked disk, and vomiting, may be regarded as contraindications to surgical interference.

6. When an injury to the skull is followed, after a lapse of some weeks, by *aphasia*, the diagnosis of abscess of the base of the third frontal convolution, or possibly involving the island of Reil or the white substance situated between the third frontal convolution and the basis of the cerebrum, may be safely made.<sup>2</sup> In such a case, the operation of trephining, as performed by Broca, affords a strong probability of relief.

7. Cases of injury which are *followed immediately by aphasia* are strongly diagnostic of either a spicula of bone or

<sup>1</sup> A respiration whose rhythm steadily increases, and then decreases, in a short interval of time ; described in 1818 by Cheyne, and by Stokes in 1846.

<sup>2</sup> Authorities are not all in accord with this statement.

the pressure of a clot in the neighborhood of the center of Broca. The former condition would be strongly in support of surgical interference, since it would probably continue to create pressure or irritation until removed, while the pressure of a clot might also be relieved by trephining.

8. If the *region over the fissure of Rolando* be subjected to apparent injury, and the symptoms of some of the *special types of monoplegia* appear (affecting the muscles of the face, arm, leg, or any of these combined<sup>1</sup>), or even the occurrence of a *slight form of hemiplegia* follow, successful trephining may be reasonably expected. The presence of anæsthesia, as before mentioned, would, however, still be a strong contra-indication to such a step, since it would prove that the lesion was probably of too deep a character to be benefited by the simple removal of a button of bone, as the posterior third of the internal capsule would probably be found to be impaired. It must be also remembered that the motor paralysis, of whatever kind it may be, must be confined to the side of the body opposite to the seat of injury, if benefit is to be expected. The type of monoplegia which exists may often be used as a guide to determine the extent of the lesion as well as its situation.<sup>2</sup>

#### GENERAL SUMMARY OF THE BRAIN, AND ITS CLINICAL RELATIONS.

We have now considered the various parts of the brain somewhat in detail, and have noted some of the points of clinical interest which each presents. Many anatomical terms have, however, been employed at various times, which may be a source of embarrassment to you, provided you are not perfectly familiar with the anatomical construction of the encephalon. I have deemed it advisable, therefore, to hastily review such anatomical points as seem important for you to grasp (as a preparation for clinical study), before I bring this

<sup>1</sup> See page 45 of this volume.

<sup>2</sup> See the motor centers situated in the ascending frontal and parietal convolutions, page 29 of this volume, and the various forms of monoplegia described in the early pages of this chapter.

subject to a close, and pass to the other portions of the nervous system.

The *gray matter* of the exterior surface (the cortex) of the cerebrum and cerebellum forms a true ganglionic mass, which is spread out over a large expanse of surface, but which, like all ganglionic masses, consists of nerve cells, nerve fibers, blood-vessels, and the connective tissue of the brain—the neuroglia. The rapid growth of the requirements which advancing age demands of this gray matter of the cortex demands a larger expanse of surface than the interior of the skull would admit of, provided this gray matter was smoothly distributed; hence the presence of convolutions, or “gyri,” and the depressions between them, the “sulci,” which are much more marked in the adult than in the infant. It should be understood also that the gray matter of the cortex is of nearly the same thickness in all portions, and that it therefore lines the sulci, as well as covers the convolutions. The foldings of the gray cortical layer are, however, not of a uniform character; hence a difference in the depth of the depressions between them. It *has* been found necessary to name some of the more prominent fissures or “sulci,” in order to have certain easily defined landmarks, for the purpose of more readily designating the separate convolutions, which are apparently arranged as a confused mass, but which are found to be uniformly developed and constant in their situation.

The admirable monograph of Ecker on the topography of the cerebral convolutions and the researches of Ferrier<sup>1</sup> and Dalton<sup>2</sup> enable us so to group these various gyri and fissures as to assist us in retaining them in our memories; while such a knowledge is indispensable to a complete understanding either of the pages which have preceded or of those which are to follow.

We may start, then, with the statement that we have to know the situation of four lobes, four lobules, and four principal fissures or “sulci.” These may be given as follows:

<sup>1</sup> *Op. cit.*

<sup>2</sup> “Text-Book of Physiology.” H. C. Lea, Philadelphia, 1876.





Let us now consider, in a superficial way, the points of value which pertain to each of these special localities, noting such guides as may suggest themselves to aid memory, and following Fig. 23 as we progress, in order to make the description more clear than words alone could do.

#### THE PRINCIPAL FISSURES OF THE CEREBRUM.<sup>1</sup>

The *ascending limb* of the *fissure of Sylvius* (*s''*) passes in front of the island of Reil and among the frontal convolutions.

The *horizontal limb* of the *fissure of Sylvius* (*s'*) passes backward behind the island of Reil, and separates the temporo-sphenoidal lobe from the frontal and parietal lobes, which lie adjoining it.

The fissure of Sylvius has a surgical and medical importance from the fact that it contains the middle cerebral artery, which is particularly liable to obstruction from the impaction of an embolus, especially upon the left side of the body; which accident is liable to be followed by aphasia, since the center of speech is supplied by this artery.

The *fissure of Rolando* (*c*) separates the frontal from the parietal lobe; it passes downward and forward from the upper part of the cerebrum till it almost joins the horizontal limb of the Sylvian fissure. It is an important surgical region (see page 40).

The *external parieto-occipital fissure* (*po*) separates the parietal and occipital lobes, hence its name. It is continued upon the inner surface of the cerebrum as the "internal parieto-occipital fissure." It is very variable in its extent, and is sometimes scarcely recognizable.

#### THE LOBES OF THE CEREBRUM.<sup>1</sup>

The **FRONTAL LOBE (F)** is contained in the anterior fossa of the skull. It presents four convolutions,<sup>2</sup> or

<sup>1</sup> See Figs. 12 and 23.

<sup>2</sup> The frequent occurrence of an accessory, or *fourth frontal convolution* in the brains of criminals is noted by Benedikt ("Centralbl. f. d. med. Wiss.," Nov., 1880). It was

“gyri,” which are specially named. These may be thus stated :

The *ascending frontal convolution*, or *gyrus* (A), which lies anterior to the fissure of Rolando, being separated from the ascending parietal convolution by that fissure.

The *superior frontal convolution*, or *gyrus* ( $F_1$ ), which joins the ascending gyrus, passing transversely across the frontal lobe.

The *middle frontal convolution*, or *gyrus* ( $F_2$ ), passing parallel to the superior.

The *inferior frontal convolution*, or *gyrus* ( $F_3$ ), lying below the middle, but still running transversely across the frontal lobe.

The PARIETAL LOBE<sup>1</sup> (P) has also four convolutions, or gyri, called the ascending, the supra-marginal, the parietal lobule, and the angular gyrus.

The *ascending parietal convolution* (B) lies back of the fissure of Rolando, being separated from the ascending frontal convolution by means of that fissure.

The *supra-marginal convolution* ( $P_1$ ), the *parietal lobule* ( $P_2$ ), and the *angular gyrus* ( $P_2'$ ), being the other three convolutions of the parietal lobe, are situated behind the ascending parietal convolution.

The TEMPORO-SPHENOIDAL LOBE (T) presents three well-marked convolutions, which run in an antero-posterior direction. They are named as follows :

The *superior temporo-sphenoidal convolution* ( $T_1$ ), which lies below the horizontal limb of the Sylvian fissure, and which is continuous behind with the parietal lobe.

found to exist, more or less completely developed, in the majority of brains of this class in his possession. It originated usually by a bifurcation of the middle frontal convolution, occasionally by a bifurcation of the superior frontal convolution. Other points of interest are presented, including the occurrence of a *fifth convolution*. These facts the author regards as the expression of a great pathological law, that atypical structure is the chief agent in the production of atypical (morbid) performance of function.

<sup>1</sup> The letters in parentheses refer to Fig. 23, although Fig. 12 will perhaps give a better conception of the convolutions to the reader.

The *middle temporo-sphenoidal convolution* ( $T_2$ ), which becomes continuous with the angular gyrus, and is connected to the middle occipital convolution.

The *inferior temporo-sphenoidal convolution* ( $T_3$ ), seen on the under surface of the cerebrum, and connected with the third occipital convolution.

The OCCIPITAL LOBE (O) presents three badly defined convolutions, which are superimposed upon each other, and which lie in a more or less antero-posterior direction.

The *superior occipital convolution* ( $O_1$ ) is connected with the parietal lobule.

The *middle occipital convolution* ( $O_2$ ) is connected with the angular gyrus, and also with the middle temporo-sphenoidal convolution.

The *inferior occipital convolution* ( $O_3$ ) is connected with the inferior temporo-sphenoidal convolution.

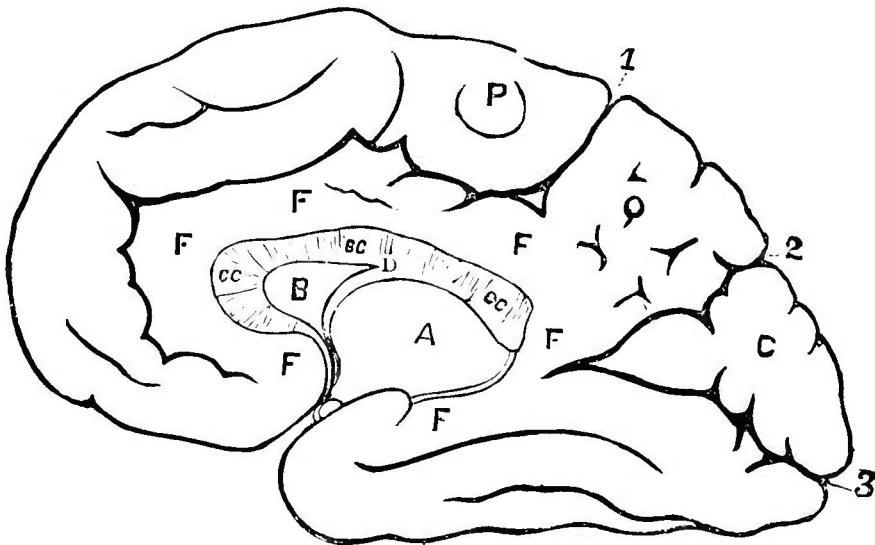

FIG. 24.—A diagram of the cerebrum in longitudinal median section. (After Dalton.)

1, callosal-marginal fissure; 2, parieto-occipital fissure; 3, calcarine fissure; A, third ventricle; B, fifth ventricle; D, anterior crura of fornix; C, cuneus (occipital lobule); Q, præcuneus (lobulus quadratus); P, para-central lobe; C C, corpus callosum; F, gyrus fornicatus.

#### THE LOBULES OF THE CEREBRUM.<sup>1</sup>

The *lobulus centralis*, or the island of Reil, is deeply situated at the bottom of the fissure of Sylvius, between the

<sup>1</sup> See Figs. 23 and 24.

frontal and the temporo-sphenoidal lobes. It presents five or six convolutions, which are nearly straight, and which are directed outward and upward. This portion of the cerebrum is probably connected with the faculty of speech. It is supplied with blood by the middle cerebral artery. It can not be well shown in a plate, on account of its situation.

The *para-central lobule* (P) is found on the internal surface of the cerebrum, in front of the lobulus cuneus. It is of great importance, from a clinical point of view, since we know that disease of this convolution is followed by secondary degeneration of the motor tract of the brain and spinal cord.

The *lobulus quadratus* (Q) is also situated upon the inner surface of the cerebrum, between the para-central lobule and the lobulus cuneus.

The *occipital lobule* (C) is triangular in form, and lies posterior to the lobulus quadratus upon the inner surface of the cerebrum.

Certain *fissures* upon the *inner surface* of the cerebrum are also perceived, whose names may be met with by you in the descriptions of existing lesions, in special works upon nervous diseases, and which are therefore enumerated. They are named as follows :

The calloso-marginal fissure.

The internal parieto-occipital fissure.

The calcarine fissure.

#### CLINICAL SUBDIVISIONS OF THE BRAIN.

In studying the brain from the standpoint of its physiology and clinical interest, an advantage is gained by a departure from the subdivisions of the encephalon found in most of our standard anatomical treatises; since many points, which could not be omitted in a descriptive treatise without the author incurring censure, are of no importance to the physiologist or pathologist, in our present ignorance as to the

functions of many parts, or the results of disease when confined exclusively to them. I am inclined, therefore, to adopt the classification of Professor Seguin, used some years ago in a course of lectures delivered upon this subject,<sup>1</sup> since it seems to possess perspicuity and many advantages from a clinical standpoint. I quote from the above author as follows:<sup>2</sup>

“For our purpose I make the following subdivisions of the encephalon—a semi-physiological classification:<sup>3</sup>

“1. The *basis cerebri*, including all the parts which lie upon the base of the skull, but more especially the pons Varolii, crura cerebri, their attached nerves, and the optic and olfactory apparatuses.

“2. The *great basal ganglia*, *i. e.*, the thalamus opticus, nucleus caudatus, nucleus lenticularis, and the corpus quadrigeminum.

“3. The *white substance* of the hemispheres, especially the internal capsule.

“4. The *cortex cerebri*.

“5. The *cerebellum*.

“The general pathological propositions relative to these parts are as follows:

“1. Lesions of the *basis cerebri*, especially if involving the pons Varolii and crura, give rise to the following symptoms: paralysis (often of crossed variety); anæsthesia in the face and limbs; impairment of equilibrium; changes within the eyes; no psychical symptoms.

“2. Lesions of the *great basal ganglia* probably produce no symptoms unless by encroaching upon the internal capsule which passes near them. An exception may be the nucleus caudatus.

“3. Lesions of the *white center of the hemispheres* produce no symptoms when they do not involve the parts composing the *internal capsule*; if the anterior portion of this

<sup>1</sup> “N. Y. Med. Record,” 1878.

<sup>2</sup> *Ibid.*, February, 1878.

<sup>3</sup> The *italics* are my own.

capsule be injured, we observe paralysis, if its posterior part, anæsthesia.

“4. Lesions of the *cortex cerebri* produce, when located anteriorly, psychical symptoms; when located in the median regions, paralysis of an imperfect kind, and when situated posteriorly, no symptoms at all (sensory symptoms in animals).

“5. Lesions of the *cerebellum* produce no symptoms except by involving adjacent parts containing important motor and sensory tracts, thus giving rise to irregular paralyses, changes in the optic apparatus, symptoms of irritation of the vagus nerve, etc.

“6. Lesions in one *lateral half* of any part of the encephalon produce motor and sensory symptoms in the side of the body opposite to the lesion. When the lesion is in one half of the basis cerebri, some symptoms (direct symptoms) are found in the side of the face and head corresponding to the lesion, others in the opposite half of the body (crossed paralysis).

“7. Lesions in the *median line* cause symptoms to appear in both sides of the body

“8. Any intra-cranial lesion which acts in such a way as to *increase the intra-cranial pressure* may produce (in addition to other symptoms) the condition known as choked disk, or neuro-retinitis.”

#### SUMMARY OF THE PHYSIOLOGY OF THE CORTEX AND THE EFFECTS OF DISEASE LOCATED IN THAT PORTION OF THE CEREBRUM.

From the statements made in previous pages, we may summarize the functions of the cortex (the gray matter of the cerebral convolutions), as well as the symptoms which can be attributed to disease confined to that region, as follows:

1. That, contrary to old statements, the cortex is capable of artificial stimulation; and that the functions of certain areas can thus be determined with an approach to accuracy.

2. That a well-defined relation exists between the cortex and certain muscular groups. This has lately been

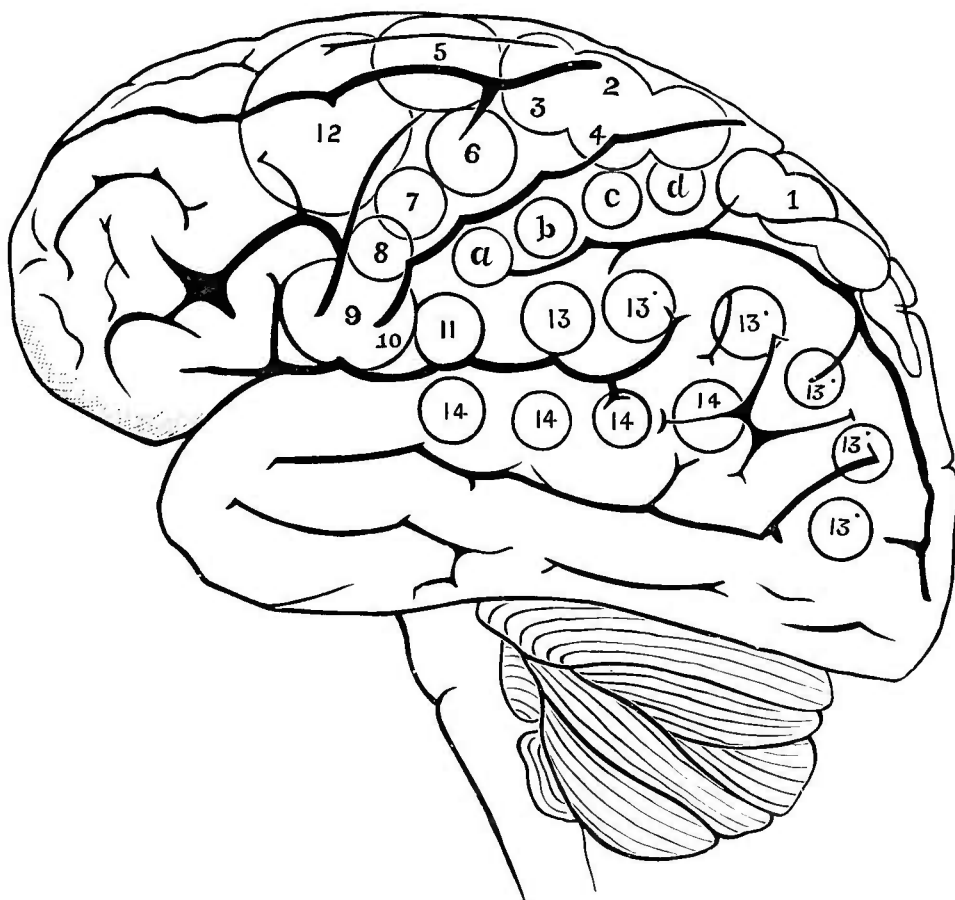

FIG. 25.—*Side view of the brain of man and the areas of the cerebral convolutions.* (After Ferrier.)

1 (on the postero-parietal [superior parietal] lobule), advance of the opposite hind-limb as in walking; 2, 3, 4 (around the upper extremity of the fissure of Rolando), complex movements of the opposite leg and arm, and of the trunk, as in swimming; *a, b, c, d* (on the postero-parietal [posterior central] convolution), individual and combined movements of the fingers and wrist of the opposite hand: prehensile movements; 5 (at the posterior extremity of the superior frontal convolution), extension forward of the opposite arm and hand; 6 (on the upper part of the antero-parietal or ascending frontal [anterior central] convolution), supination and flexion of the opposite forearm; 7 (on the median portion of the same convolution), retraction and elevation of the opposite angle of the mouth by means of the zygomatic muscles; 8 (lower down on the same convolution), elevation of the ala nasi and upper lip with depression of the lower lip, on the opposite side; 9, 10 (at the inferior extremity of the same convolution, Broca's convolution), opening of the mouth with 9, protrusion, and 10, retraction of the tongue—region of aphasia, bilateral action; 11 (between 10 and the inferior extremity of the postero-parietal convolution), retraction of the opposite angle of the mouth, the head turned slightly to one side; 12 (on the posterior portions of the superior and middle frontal convolutions), the eyes open widely, the pupils dilate, and the head and eyes turn toward the opposite side; 13, 13 (on the supra-marginal lobule and angular gyrus), the eyes move toward the opposite side with an upward 13, or downward 13' deviation; the pupils generally contracted (center of vision); 14 (of the infra-marginal, or superior [first] temporo-sphenoidal convolution), pricking of the opposite ear, the head and eyes turn to the opposite side, and the pupils dilate largely (center of hearing). Ferrier, moreover, places the centers of taste and smell at the extremity of the temporo-sphenoidal lobe, and that of touch in the gyrus uncinatus and hippocampus major.

confirmed on the human subject by Dr. Amidon, of this city <sup>1</sup>

<sup>1</sup>“Dr. Amidon’s experiments<sup>1</sup> in *cerebral localization* are based on the following propositions: 1. Marked local variations in the temperature of the cephalic contents can be demonstrated by *surface thermometers*. 2. Cerebral cortical localization is now so far advanced as to warrant the assertion that the psycho-motor centers for one half the body occupy a certain area in the cerebral cortex of the opposite hemisphere. 3. Functional activity of an organ implies increased blood supply and tissue change, and consequent *elevation of the temperature* of that organ. 4. Willed contraction of muscles presupposes an increased activity of the volitional motor center of those muscles in the cerebral cortex. From this it was natural to make the deduction that voluntary activity in a peripheral part would cause a *rise of temperature in the psycho-motor center* for that part, which might be indicated by external cerebral thermometers.

“Seguin’s self-registering surface thermometers were used, numbers of which were applied to the surface to be tested by passing them through holes in rubber straps secured to the head by buckles. The desirable points in the subject experimented on are, a well-shaped head, thin hair, well-developed and trained muscles, power of facial expression, especially of unilateral facial movements and the ability to contract individual muscles, and moderate intelligence. A man is preferable to a woman, and a European to an African. The mode of performing and recording experiments and the liabilities to error are all fully described, and the following results are given.

“The part of the brain underlying the trapezius area is thus seen to be the anterior part of the first frontal convolution. Farther back on the same comes the deltoid, and farther still the biceps area, while that of the triceps probably overlaps to a slight degree the fissure of Rolando. The area for the scaleni, etc., will fall on the second frontal convolution, in front of its middle; that for the deep extensors of the neck, on the second frontal convolution, near its middle. The pectoralis area will fall on the middle of the second frontal convolution, slightly overlapping the superior frontal sulcus. The area for the latissimus dorsi occupies a similar position farther back. The point of junction of the superior and ascending frontal is occupied by the hand and finger flexors, while lower on the ascending frontal lies the area for the elevators of the angle of the mouth, and lower still, that for the orbicularis oris, in front of and above which is the area for the tongue and the hyoids, which lies on the third frontal convolution. At the base of the ascending parietal convolution, but reaching a slight distance across the fissure of Rolando, lies the platysma area; higher, the area for the orbicularis palpebrarum, and higher still, lying partly on the ascending parietal, and partly on the ascending frontal convolutions, is the area for the extensors of the hand and fingers. The anterior part of the superior parietal lobule holds the anterior tibial area, behind which lies that of the calf of the leg. On the posterior part of the superior parietal lobule, but falling chiefly on the first and second occipital gyri, is found the area for the quadriceps extensor femoris, while on the third occipital gyrus and the posterior part of the inferior middle temporal lobule will fall the area for the abdominal muscles. On the posterior parts of the angular gyrus and middle temporal lobule will fall the psoas and iliacus area. The rather indefinite area marked out for the erector spinæ overlies about equally the posterior part of the upper and of the middle temporal lobules, while higher up, over the contiguous portions of the angular and supra-marginal gyri and the superior temporal lobule, is the area for the flexors of the leg on the thigh. On the upper part of the supra-marginal gyrus will fall the area set apart for ocular movements. This transference of the motor areas from the scalp to the brain leaves but little of the cerebral convexity uncovered, viz., the anterior half of the temporo-sphenoidal lobe and the extreme

<sup>1</sup> Prize Essay of 1880, “Archives of Medicine,” April, 1880.



3. That the *excitable region* of the cortex, where motor effects are chiefly produced, may be stated to be localized in the following parts, if we accept the results obtained by Ferrier: The ascending frontal convolution; the base of the first frontal convolution; the second frontal convolution; the third frontal convolution; the ascending parietal convolution; the first parietal convolution; and the para-central lobule. Now, let us see what centers pertain to each of these convolutions.

The center for *movements of the lips and tongue* (the true speech center) lies at the base of the *third frontal convolution*, near the fissure of Sylvius. (See 9, 10, on Fig. 25.) Upon the *first and second frontal convolutions*, you will find a center (see 12, on Fig. 25): (1) For *lateral movements of the head*; (2) for *elevation of the eyelids*; and (3) for *dilatation of the pupil*.

The *ascending frontal convolution* presents, from below upward, the following centers: For *elevation and depression* of the corners of the mouth (8 and 7); for *movements of the forearm and the hand* (6); for *extension and the forward movement of the hand and the arm* (5); centers for *complex movements of the arms and legs*, when acting together (2, 3, and 4).

The *ascending parietal convolution* presents, from above downward, four centers for *complex movements of the hand and wrist* (*a, b, c, d*), such as the use of individual fingers, prehensile movements, etc. At its most superior portion, the centers (2, 3, and 4), which control the alternating movements of the arm and leg, as in the act of swimming, seem to overlap the ascending parietal convolution; but they are not definitely placed.

The *superior parietal convolution* presents the center which presides over the *movements of the leg and foot*, as in the act of walking.

anterior frontal region. These areas are held to be the outward representation of psychomotor centers in the cerebral cortex." (Report in "New York Med. Jour.," October, 1880.)

The *para-central lobule*, when diseased or excised, seems to exert, through some influences, a gradually extending process of *secondary degeneration of the spinal cord*.

4. The *sensory region* of the cortex is confined to the parietal, temporal, and occipital lobes of the cerebrum. In it certain centers have been definitely located by Ferrier, which are not, as yet, accepted as fully proven, but which are considered as being rather supported than confuted by clinical and physiological evidence.

The *angular gyrus* is said by this author to present the *centers for vision* (13, 13), while movements of the eyes also are produced when these regions are stimulated.<sup>1</sup>

The *superior temporo-sphenoidal* convolution is also said to present the *centers of hearing* (14, 14, 14), while the head and eyes are caused to move toward the opposite side and the pupils to dilate largely.

5. The collection of reported cases of tumors, clots, softening, pressure effects (from exostoses, meningeal exudations, or thickenings, etc.), seems to confirm, to a greater or less extent, the effects of physiological experiment or faradization, and that the following general statements as to the results of lesions of the cortex can be safely used as possessing practical value at the bedside.

(a) When the *faculty of speech* is affected to any extent, or the symptoms of amnesic aphasia exist, it is safe to conclude that the lesion involves one of three situations, viz. : the anterior convolutions of the island of Reil, the base of the third frontal convolution, or the white substance lying between the third frontal convolution and the base of the cerebrum.<sup>2</sup> The lesion, being most frequently met with upon the left side of the brain, will usually be asso-

<sup>1</sup> Experiments of Ferrier, Yeo, Dalton, and others.

<sup>2</sup> E. C. Seguin, "Med. Record," 1878.

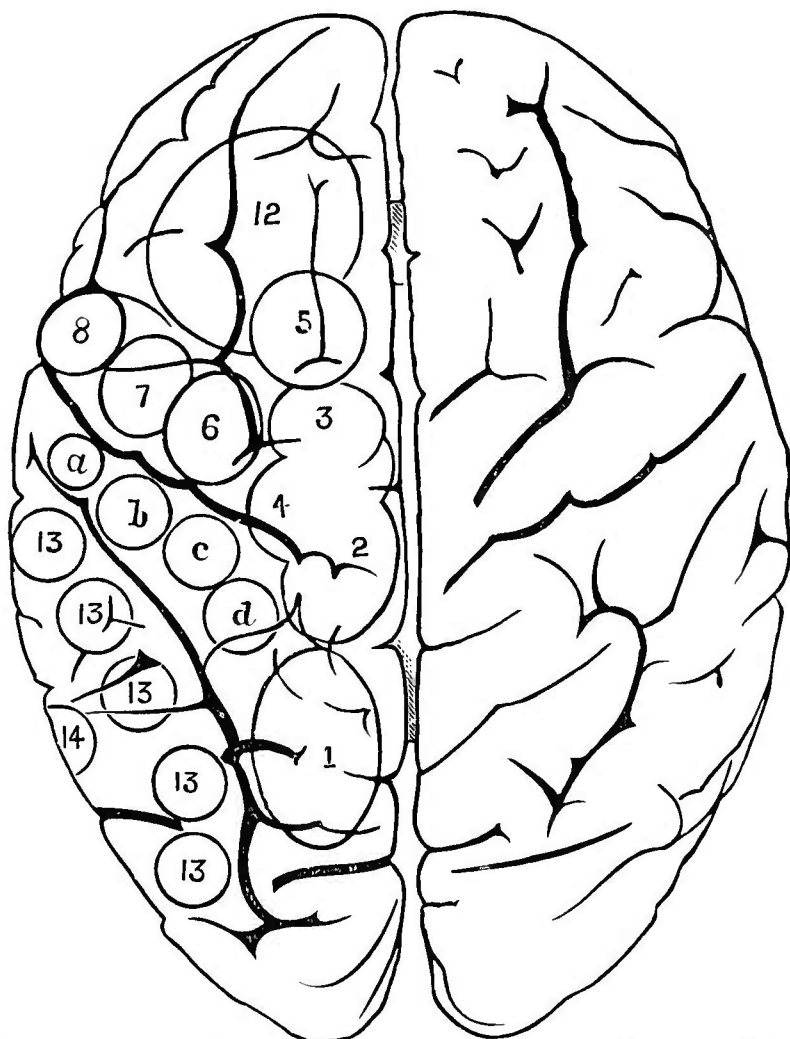

FIG. 26.—Upper view of the brain of man and the situation of areas of the cerebral convolutions. (After Ferrier.)

1 (on the postero-parietal [superior parietal] lobule), advance of the opposite hind-limb as in walking; 2, 3, 4 (around the upper extremity of the fissure of Rolando), complex movements of the opposite leg and arm, and of the trunk, as in swimming; *a*, *b*, *c*, *d* (on the postero-parietal [posterior central] convolution), individual and combined movements of the fingers and wrist of the opposite hand; prehensile movements; 5 (at the posterior extremity of the superior frontal convolution), extension forward of the opposite arm and hand; 6 (on the upper part of the antero-parietal or ascending frontal [anterior central] convolution), supination and flexion of the opposite forearm; 7 (on the median portion of the same convolution), retraction and elevation of the opposite angle of the mouth by means of the zygomatic muscles; 8 (lower down on the same convolution), elevation of the ala nasi and upper lip with depression of the lower lip, on the opposite side; 9, 10 (at the inferior extremity of the same convolution, Broca's convolution), opening of the mouth with 9, protrusion, and 10, retraction of the tongue—region of aphasia, bilateral action; 11 (between 10 and the inferior extremity of the postero-parietal convolution), retraction of the opposite angle of the mouth, the head turned slightly to one side; 12 (on the posterior portions of the superior and middle frontal convolutions), the eyes open widely, the pupils dilate, and the head and eyes turn toward the opposite side; 13, 13 (on the supra-marginal lobule and angular gyrus), the eyes move toward the opposite side with an upward 13, or downward 13' deviation—the pupils generally contracted (center of vision); 14 (of the infra-marginal, or superior [first] temporo-sphenoidal convolution), pricking of the opposite ear, the head and eyes turn to the opposite side, and the pupils dilate largely (center of hearing). Ferrier, moreover, places the centers of taste and smell at the extremity of the temporo-sphenoidal lobe, and that of touch in the gyrus uncinatus and hippocampus major.

ciated with some form of *paralysis affecting the right side* of the body; but the faculty of speech may be affected by lesions of the right side as well as those of the left side.

- (b) Paralysis of motion *affecting the upper extremity*, either entirely or to a greater extent than other parts involved,<sup>1</sup> suggests a lesion which is situated on the side opposite to the paralysis; and either confined to, or involving, the *ascending convolutions* of the frontal or parietal lobes.
- (c) When the *facial muscles* are prominently affected, I am inclined to think the lesion may be located in the frontal lobe, anterior to or in the vicinity of the *pre-central fissure* or *sulcus*.<sup>2</sup>
- (d) When the *muscles of the leg*<sup>3</sup> are exclusively affected (and the probability of spinal lesions involving only the lateral half of the spinal cord can be excluded), or when the leg muscles, in an attack of hemiplegia of clear cranial origin, show special impairment, the lesion can be probably placed at the *upper end of the fissure of Rolando*, affecting the ascending convolutions of the frontal or parietal lobes.
- (e) That lesions of the *sensory area* of the cerebral cortex are not understood in their *clinical aspects*, since little opportunity has been afforded for the pathological study of this type of cases.
- (f) That all of the symptoms produced by lesions of the cortex may be the result either of *actual destruction* of the nerve tissue of the cortex, or *evidences of irritation* of the cortex; and that the symptoms will differ in the two cases, so as to often assist the diagnostician.
- (g) That lesions of the cortex, if *outside of the motor area*, will produce no symptoms, unless they involve the *dura mater*; in which case, the diseased condition may be

<sup>1</sup> See the peculiar types of *brachial monoplegia*, as described on pages 45 and 46 of this volume.

<sup>2</sup> It may not be confined alone to this region, since the various forms of brachial monoplegia are often associated with facial paralysis.

<sup>3</sup> See the types of *crural monoplegia*, described on pages 40 and 42 of this volume.

manifested by *convulsions*, and, possibly, by *headache*. These convulsions, and the headache which may be produced, are respective evidences of irritation of some portion of the motor area of the cortex, or of adjoining sensory areas.

- (i) That the symptoms which prominently indicate *irritation of the cortex* are *convulsions*, which are often *followed by paralysis*. This paralysis may be either of the transient or permanent variety, although the former is the more common. The groups of muscles which are prominently affected in the convulsive attacks may afford the physician a guide to the seat of the irritation, since the same centers are probably affected, as if the corresponding muscles were paralyzed, rather than convulsed.
- (j) The *destructive lesions* of the gray matter of the cerebral convolutions, if limited to the motor area, produce peripheral paralysis of the parts governed by the centers which are involved, but on the side of the body *opposite* to the situation of the *seat of disease*. Thus embolism, by plugging the middle cerebral artery, shuts off the blood supply to the center of Broca, and *aphasia* will usually be produced; with an accompanying hemiplegia of the side opposite to the embolus, in case the blood supply is impaired to other parts of the motor area. A destructive lesion of the motor region, if not due to embolism, is liable to produce hemiplegia, without aphasia, on the opposite side to the seat of disease; but it exists to a greater or less extent when the motor area of the cortex is affected in any part.
- (k) When the *paralyzed muscles become rigid*, after an attack of hemiplegia, from destructive lesions of the motor area of the cortex, it may be considered as an evidence of a *secondary degeneration* of the nerve fibers, which is progressing downward along the spinal cord. This is prominently developed when the para-central lobule is the seat of disease, but it exists, to a greater or less extent, when the motor area of the cortex is affected in any part.

- (*l*) In those cases where the lesions are *diffused over a large surface* of the cortex (as in the exudation of acute meningitis, suppuration between the bone and the dura mater, etc.), *delirium, convulsions, and local pain*, are often present, and may properly be regarded as evidences of the excessive irritation which exists in consequence of the pressure and hyperæmia. *Coma* and *paralysis* may follow; in which case they are to be attributed, either to the local anæmia produced by the pressure (thus causing impairment of nutrition to the subjacent cortex), or to circulatory changes and increased tension of the entire brain.
- (*m*) The affection called “diffuse meningo-encephalitis” or the “general paralysis of the insane” is so commonly met with, and affords such striking evidences of the effects of *general pressure upon and irritation of* the cerebral cortex, that its symptoms have to the neurologist more than a clinical interest. From a careful study of such cases, we learn that the symptoms first manifested are contractions of special fibers in the muscles of the face, tongue, and limbs, and that the speech becomes tremulous and the articulation spasmodic. Later on, acute delirium and impairment of memory and judgment appear, and a state of the muscles of the limbs develops which may be one either of semi-paralysis or of semi-ataxia. In the final stages, the mental faculties become abolished; a state of insanity, characterized by periods of delirium, is produced; and the patient dies without any apparent changes in the ordinary organic functions of the body.

I would repeat, that a person exhibiting tremors of the facial muscles, of the tongue, and hand, a vibratory and slurred speech, angular or tremulous handwriting, and irregular, small pupils, should be suspected of having chronic peri-encephalitis or paralytic dementia. The addition of gradual failure of mind—true dementia—makes the diagnosis certain. In case there should be added to these above-named symptoms exalted notions, with ma-

niacal attacks and epileptiform seizures, the case deserves the name of general paresis, and as such the form is more usually seen and studied by asylum physicians.

6. The physiology of the *great ganglia of the cerebrum* is far from being satisfactorily determined, since the experiments of different observers apparently prove most glaring contradictions. It is, however, probable that the two subdivisions of the corpus striatum (the caudate and the lenticular nuclei) have motor functions of a character which are not yet positively decided, while the attributes of the optic thalamus are still involved in obscurity.<sup>1</sup>

7. It can safely be considered as proven that the *corpora quadrigemina* (the nates and testes) are, in some way, concerned in the special sense of vision, and belong to the optic apparatus, although the motions of the eyeball seem to be more directly influenced than vision itself. For the experiments which seem to prove this, the reader is referred to page 58 and 59 of this volume.

8. The *internal capsule* of the cerebrum seems to be one of the most important regions of the brain, from a clinical standpoint, since the slightest pressure upon it produces symptoms which vary with the portion pressed upon, and since a *secondary degeneration*,<sup>2</sup> which descends along the nerve fibers of the crus, pons, medulla, and spinal cord, is inevitably the result of disease of this portion of the cerebrum. If the *anterior two thirds* of the internal capsule be the seat of pressure or disease, *hemiplegia* of the opposite side results; if the *posterior third* be affected, a condition of *anæsthesia* of the opposite side is produced. *Choreic movements*, which vary in degree and type, and which may appear as athetosis, ataxia, true chorea, or tremor, are strongly diagnostic of lesion of the internal capsule, provided they follow an attack of hemiplegia or hemi-anæsthesia.

<sup>1</sup> To what extent this ganglion presides over or influences sensory perceptions must be considered unsettled. For opinions on the subject, the reader is referred to page 57 of this volume.

<sup>2</sup> For the effects of this descending type of secondary degeneration of nerve tissue, see page 44 of this volume.

9. The *parts adjoining the internal capsule* (the caudate nucleus, the lenticular nucleus, the white center of the frontal lobe, and the optic thalamus), if the seat of hæmorrhage, tumors, or other lesions which are capable of causing pressure upon it, may produce symptoms similar to those of disease of the internal capsule itself.

10. When the *central portions* of the cerebral hemispheres are the seat of some type of disease which has been suddenly developed, as in hæmorrhage, acute softening, etc., symptoms *referable to the optic apparatus* are usually present, in addition to the other symptoms which have been given above. Thus the eyes are often turned away from the paralyzed side, and, therefore, toward the seat of the lesion ; the head also is usually similarly turned ; and, in case the injury done to the brain is severe or extensive, a very marked rise in the surface temperature of the body will be observed.

11. When the *pressure upon the central portions* of the cerebral hemispheres is *gradual*, as in the case of growing tumors, we have developed certain special signs, which depend upon the situation of the tumor and the line of its greatest pressure ; but we are also liable to have evidences develop in the eye, which are called those of “neuro-retinitis,” and may result in the condition known by ophthalmologists as the “choked disk.”



# THE CRANIAL NERVES.

*THEIR ANATOMY, PHYSIOLOGY, AND CLINICAL VALUE.*



## THE CRANIAL NERVES.

---

THE nerves which arise from the brain are arranged as<sup>1</sup> twelve pairs, which from before backward are called the olfactory, optic, motor oculi, trochlearis, trigemini, abducens, facial, auditory, glosso-pharyngeal, pneumogastric, spinal accessory, and hypo-glossal. All of these, excepting the ninth, tenth, and eleventh pairs, are confined in their distribution to the head; while the other three have a distribution to the structures of the neck and trunk.

### THE OLFACTORY NERVE.

The first cranial nerve or nerve of smell consists (1) of three roots; (2) an olfactory process; (3) a bulb; and (4) terminal branches, which are distributed to the cavities of the nose.

The three roots are called the *external*, *middle*, and *internal*.

The external root arises apparently from the posterior border of the fissure of Sylvius, and is said to be traceable to the corpus striatum, the anterior commissure, the optic thalamus, and the island of Reil. The internal or short root is said by Foville to be connected with the longitudinal fibers of the gyrus fornicatus. The middle or gray root arises from a pyramidal mass of gray matter, the *caruncula mammillaris*.

<sup>1</sup> Willis has divided the cranial nerves into nine pairs, grouping the seventh and eighth nerves as one pair, and the ninth, tenth, and eleventh as one pair.

All three of the roots join to form a band, which is prismoidal in form (the olfactory process or tract), which passes forward

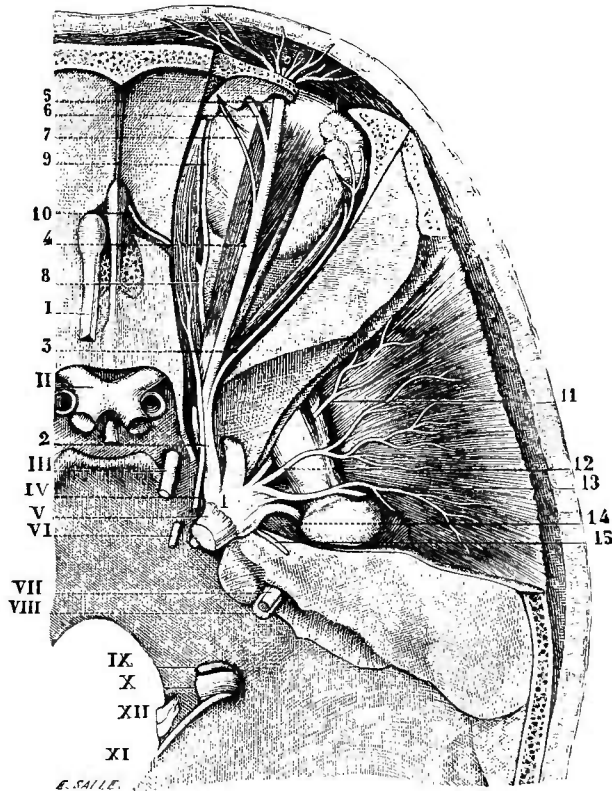

FIG. 27.—*Roots of the cranial nerves.* (Hirschfeld.)

- I. First pair; olfactory.
- II. Second pair; optic.
- III. Third pair; motor oculi communis.
- IV. Fourth pair; patheticus.
- V. Fifth pair; nerve of mastication and trifacial.
- VI. Sixth pair; motor oculi externus.
- VII. Facial, } Seventh pair.
- VIII. Auditory, }
- IX. Glosso-pharyngeal, } Eighth pair.
- X. Pneumogastric, }
- XI. Spinal accessory, }
- XII. Ninth pair; sublingual.

The numbers 1 to 15 refer to branches which will be described hereafter.

along the floor of the brain in a deep sulcus till it expands into the terminal enlargement, known as the “olfactory bulb,” or “ganglion.” This terminal enlargement lies upon the *upper surface* of the *cribriform plate* of the ethmoid bone, through the numerous foramina of which its branches escape, as small, thread-like filaments; which subsequently form a plexus upon the surface of the Schneiderian, or pituitary, membrane of the nose.

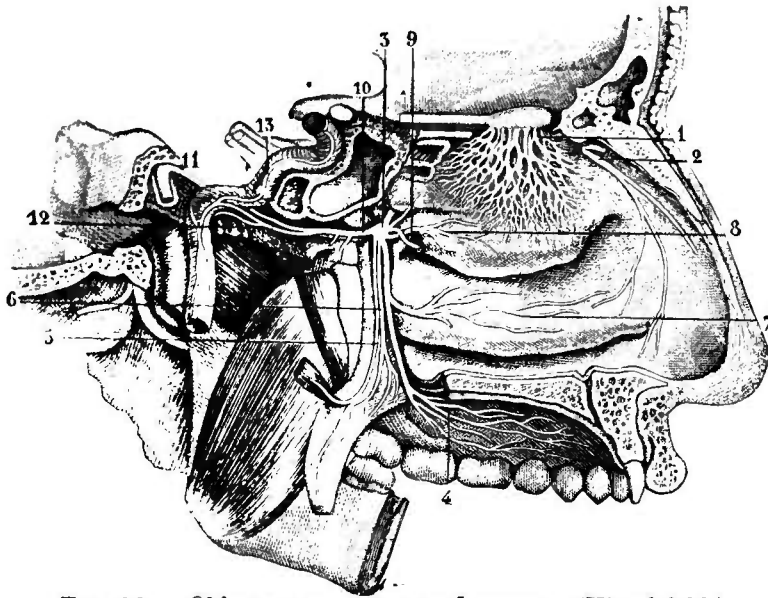

FIG. 28.—*Olfactory ganglion and nerves.* (Hirschfeld.)

1, *olfactory ganglion and nerves*; 2, branch of the nasal nerve; 3, spheno-palatine ganglion; 4, 7, branches of the great palatine nerve; 5, posterior palatine nerve; 6, middle palatine nerve; 8, 9, branches from the spheno-palatine ganglion; 10, 11, 12, Vidian nerve and its branches; 13, external carotid branch from the superior cervical ganglion.

The filaments of the olfactory nerve are described by Messrs. Todd and Bowman<sup>1</sup> as differing in their structure from the ordinary filaments found in the other cranial nerves, in that they contain no white substance of Schwann, and are nucleated and finely granular in texture. This absence of the white substance, found in other nerves, renders it difficult to trace their course in the Schneiderian membrane; which difficulty is still further enhanced by the existing nuclei, which resemble those of the tissues through which they pass.

The limit of distribution of the olfactory nerves seems to be confined to the superior three fourths of the septum of the nose, the superior turbinated bone, the upper half of the middle turbinated bone, and the roof

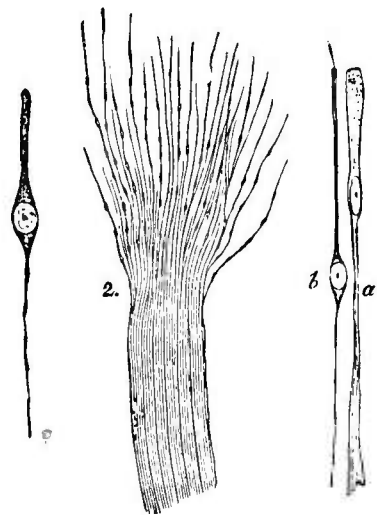

FIG. 29.—*Terminal filaments of the olfactory nerves; magnified 30 diameters.* (Kölliker.)

1, from the frog—*a*, epithelial cells of the olfactory region; *b*, olfactory cells. 2. Small branch of the olfactory nerve of the frog, separating at one end into a brush of varicose fibrils. 3. Olfactory cell of the sheep.

<sup>1</sup> "Physiological Anatomy."

of the nasal cavities ; all of which seems to be defined by a brown-colored tessellated epithelium.

Odorous particles, present in the inspired air, as they pass through the lower chambers of the nares, are diffused into the upper nasal chambers, and, falling upon the olfactory epithelium,<sup>2</sup> produce sensory impulses which are transmitted to the brain and give rise to the sensations of smell.

Forced inspiration, or sniffing, increases the upward diffusion of inspired air, and thus a more complete contact of the odorous particles is insured.

It seems that, for the development of smell, the odorous particles must be transmitted to the nasal mucous membrane in a *gaseous* medium, as the simultaneous contact of fluids destroys all appreciation of odor.<sup>2</sup>

Animals with a very acute sense of smell have a modified arrangement of the turbinated bones, to afford a larger expanse of surface than exists in man.

It has been asserted by some physiologists that the olfactory nerve is not the only nerve of smell, and Magendie claimed that animals could perceive the odor of some substances after the olfactory bulbs had been removed. He used ammonia, however, as a test in his experiments, which is hardly a test of smell, as it is a powerful stimulant to the fifth nerve.

Bernard<sup>3</sup> reports cases of absence of the olfactory bulbs in man, where smell existed during life. Prevost,<sup>4</sup> however, claims that section of the olfactory bulbs entirely destroys the sense of smell. Injury to the *fifth nerve* may also destroy smell, even where the olfactory nerve remains intact ; but this effect is hardly a proof that the nerve is in any way related to that special sense, since the effect is probably due to an *altered condition of the nasal mucous membrane*, which prevents its performing its natural function. The loss of smell may, therefore, be of some diagnostic value, if associated with other symptoms referable to impairment of the fifth cranial nerve.

<sup>1</sup> Max Schultze.

<sup>2</sup> Mich. Foster, "Text-Book of Physiology."

<sup>3</sup> "Syst. nerv.," vol. ii.

<sup>4</sup> "Archives de sci. phys. et nat.," 1871.

It seems necessary, in all animals which live in the air, that all odorous materials must enter the nostril to be perceived, and, furthermore, that the membrane of the nose must be in a proper condition of moisture; hence, by breathing through the mouth, the most disagreeable of odors may usually be unperceived, and the blunted sensibility of the power of smell, which occurs in catarrh, may plausibly be explained as the result of a deficient secretion in the early stage of the attack, and of excessive secretion later on in the disease. The curious effects of section or injury of the fifth cranial nerve upon the sense of smell may justly be attributed to the alteration in the amount of secretion of the lining membrane of the nose, since this nerve exerts a marked influence upon the secretions of the tissues supplied by it.

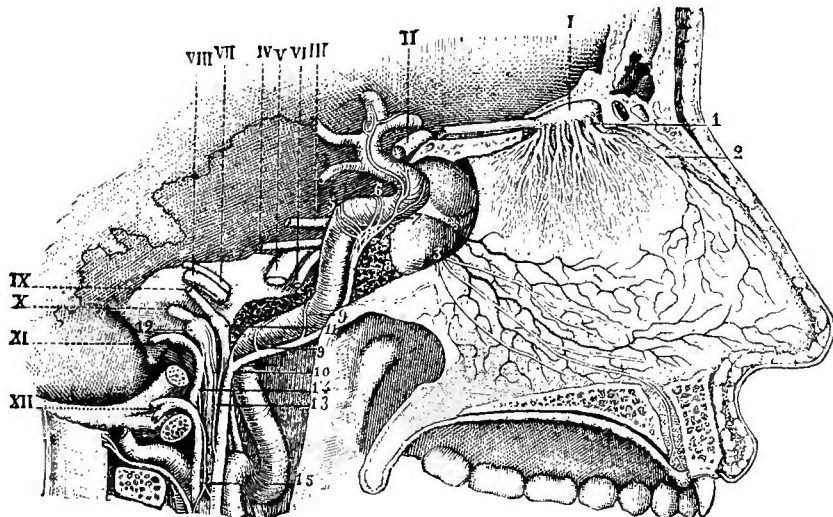

FIG. 30.—*Internal branches of the olfactory nerve.* (After Sappey.)

1, internal branches of the olfactory bulb, ramifying in the mucous membrane covering the septum of the nasal fossæ; 2, internal branch of the ethmoidal division of the nasal nerve; 3, naso-palatine nerves; 4, 5, 6, cavernous plexus; 7, superior or ascending branches of this plexus; 8, internal carotid branch from the superior cervical ganglion; 9, 9, filaments connecting this branch with the external carotid branch; 10, origin of this branch; 11, ganglion of the glosso-pharyngeal; 12, jugular ganglion of the pneumogastric; 13, anastomotic filaments extending from the sympathetic to the two preceding nerves; 14, anastomosis of the spinal accessory with the pneumogastric; 15, filament connecting the sympathetic with the hypoglossal; I, olfactory; II, optic; III, motor oculi; IV, patheticus; V, trigeminus; VI, abducens; VII, facial; VIII, auditory; IX, glosso-pharyngeal; X, pneumogastric; XI, spinal accessory; XII, hypoglossal.

The *act of sneezing*, by which a forcible blast of air is driven through the nostrils, is often an effort on the part of Nature to get rid of some irritating substance; and thus,

through the agency of the fifth nerve, is the nose made the *portal of the respiratory apparatus*, where cognizance of the quality of the air breathed is constantly taken, and where all foreign or injurious matters are at once detected, and often expelled.

A marked peculiarity of the olfactory nerve is shown by the fact that no form of irritation of its fibers excites reflex muscular action through other nerves;<sup>1</sup> neither is it capable of the sensation of pain, since section of the nerve, or even the destruction of the olfactory ganglia, seems to create no special distress in animals, and the nose retains its normal sensitiveness until the fifth nerve is also divided.

The olfactory nerve, however, may be the source of another variety of marked reflex action. Many cases are recorded where *fainting* and *vomiting* have been produced by certain odors; while, for some unexplained reason, mental associations cluster around sensations of smell more strongly than any other form of impression received from without.<sup>2</sup>

The importance of the sense of smell among many of the lower animals, in guiding them to their food, or in giving them warning of danger, and also in exciting the sexual feelings, is well known. Among the savage tribes, whose senses are more cultivated than those of civilized nations, the scent is almost as acute as in the lower mammalia. It is asserted by Humboldt that the Peruvian Indians, in the middle of the night, can thus distinguish the different races, whether European, American, Indian, or Negro.

The agreeable or disagreeable character assigned to any particular odor is by no means constant among different individuals. Many of the lower animals pass their whole lives in the midst of odors which are to man (in a civilized condition) in the highest degree revolting, and will even refuse to touch food until it is far advanced in putridity.<sup>3</sup>

<sup>1</sup> Carpenter, "Principles of Physiology." The act of *vomiting* may possibly be considered as an exception to this statement.

<sup>2</sup> Mich. Foster, "Text-Book of Physiology," 1880; Todd and Bowman, "Physiological Anatomy."

<sup>3</sup> Carpenter, "Principles of Human Physiology."



It is difficult to say when effluvia have been completely removed from the nasal passages, since it is not unlikely that odorous particles (supposing such to exist) are often absorbed, or possibly dissolved by the mucous secretion. It frequently happens, in regard to odors and savors, that habit makes that agreeable, and even strongly relished, which was at first avoided; the taste of an epicure for game that has acquired the *fumet*, for assafoetida, garlic, etc., is an instance of this. A case is reported, where, in a state of hypnotism, a youth had his sense of smell so remarkably heightened as to be able to assign, without the least hesitation, a glove placed in his hand to its right owner, in the midst of about thirty persons, the boy himself being blindfolded;¹ but modified forms of this excessive development of this power of smell are by no means rare.

The word "taste" is often used when the word "smell" should be employed. We speak of tasting odoriferous substances, such as onions, wines, etc., when in reality we only smell them as we hold them in the mouth. This is proved by the fact that the so-called taste of these things is lost when the nose is held or the nasal membrane rendered inert by a catarrh.²

#### CLINICAL POINTS AFFORDED BY THE OLFACTORY NERVE.

The nerves of smell may become the seat of disease, or may simply manifest the presence of disease in other parts. The two conditions, which are clinically recognized as indicative of existing disease, are hyperæsthesia and anæsthesia—not of the sensibility of the part, in its generally accepted sense, but an increase or decrease of the acuteness of the olfactory sense.³

¹ Carpenter, *op. cit.*

² Foster, *op. cit.*

³ According to Althaus, if the mucous membrane of the nose be irritated with very strong galvanic currents, the *taste of phosphorus* is produced; but no perception of odors is perceived, although pain, vertigo, and sensations of light may be created. It is customary, therefore, to use other means for the purpose of testing the acuteness of this special sense, and the most successful method consists of making the patient smell different odors, using the nostrils alternately, and avoiding all things, as tests, which would create an irritation of the filaments of the fifth nerve, such as ammonia, acetic acid, snuff, etc. (Hence the defect in Magendie's experiments mentioned on page 98.) It is advisable

To the former condition, the term "*hyperosmia*" is applied, while the latter is called "*anosmia*."

The condition of hyperosmia is often perceived, as a temporary excitation, in patients recovering from some prolonged disease which has exhausted their nervous power, and also in the hysterical and insane.<sup>1</sup> Should the presence of unnatural odors, or a marked increase of the susceptibility to odors, exist in the insane, it may indicate the existence of some type of neoplasm involving the frontal lobes at the base of the cerebrum, localized disease (softening, as a rule) of the olfactory bulbs, or adhesion of the olfactory bulbs to the dura mater; since all of these conditions have been found at autopsies, where such symptoms existed during life. Sander reports a curious case, where such a subject was liable to epileptic attacks, and where the attacks were associated with abnormal sensations of taste; the autopsy showed a tumor of the left olfactory bulb.

The *abolition* of the sense of smell is a symptom of greater frequency, as well as importance, than the excitation of that special sense. In rare cases, as in one reported by Cloquet, the absence of the power of smell may be a congenital defect. Anosmia may be developed, as a *temporary* condition, during an attack of acute catarrhal inflammation of the nares, which alters the character of the membrane, or, in chronic catarrh, by the effect upon the natural moisture of the mucous lining of the nose. It may be present in "Bell's paralysis,"<sup>2</sup> since the facial nerve no longer affords motor power to the muscles which dilate the nostril, and thus the entrance of air to the upper nasal chamber is obstructed. Anosmia may be one of

to use odors which are both agreeable and disagreeable; hence cologne, camphor, musk, etc., on the one hand, and valerian, assafoetida, turpentine, sulphureted hydrogen, etc., on the other hand, are commonly employed. It is also customary to place *aromatic substances*, such as coffee, wine, liquors, and cheese, *within the mouth*, so that the posterior part of the nose can perceive them, since the odoriferous particles pass upward by means of the pharynx, rather as an imaginary taste, however, than as true olfactory perceptions.

<sup>1</sup> Frequently odors of the most pleasant character, such as those of flowers, etc., may occasion fainting, nausea, headache, or even convulsions, in this class of patients; while odors nauseating to others may be tolerated, and, possibly, preferred by them.

<sup>2</sup> For the symptoms of this affection, see pages of this volume descriptive of the facial nerve.

the manifestations of tumor at the base of the brain; of abscess of the pituitary body (as reported by Oppert); of syphilitic thickening of the periosteum and mucous lining of the nose; of lesions resulting in paralysis of the fifth cranial nerve, for some unexplained reason; of hysteria; and, finally, of certain types of insanity. A partial loss of smell has been known to follow typhoid fever and meningitis, in which case the sense is usually regained. Chronic rheumatism, chronic rhinitis, and traumatism, have also proven exciting causes of a temporary but serious loss of the sense of smell.<sup>1</sup>

#### THE OPTIC NERVE.

The second cranial or optic nerve presents for examination from before backward: 1, the optic nerve proper; 2, the optic commissure; and 3, the optic tract.

The *optic tracts* of either side extend from their point of origin in the *corpora quadrigemina*, where they receive a few fibers from the optic thalamus,<sup>2</sup> to the optic commissure, to reach which point, each is compelled to pass around the *crus cerebri*. In their passage around the *crus*, each tract receives a few fibers of attachment at its anterior margin; and, after leaving the *crus*, just before the optic chiasm is formed, each receives additional fibers from the *lamina cinerea* and the *tuber cinereum*.

The *optic commissure* or *chiasm* is formed by the junction of the two optic tracts, and from it the two optic nerves diverge to pass to their distribution in the retina of either eye. The construction of the optic chiasm is of interest both from an anatomical and a physiological standpoint. In it, four sets of fibers may be demonstrated, called, respectively,

<sup>1</sup> In almost all cases, where anosmia affects both sides of the nasal cavity, the sense of taste is also impaired. All aromatic forms of food and wines have a distorted flavor. It is claimed by Ogle that the pigment in the olfactory mucous membrane has some effect upon the sense of smell.

<sup>2</sup> Physiological experiment seems to point to the *angular gyrus* as intimately connected with the deep fibers of the optic nerve (see pages 51 and 52 of this volume).

the *inter-cerebral* fibers, which are situated at the posterior portion of the commissure, and connect the two hemi-

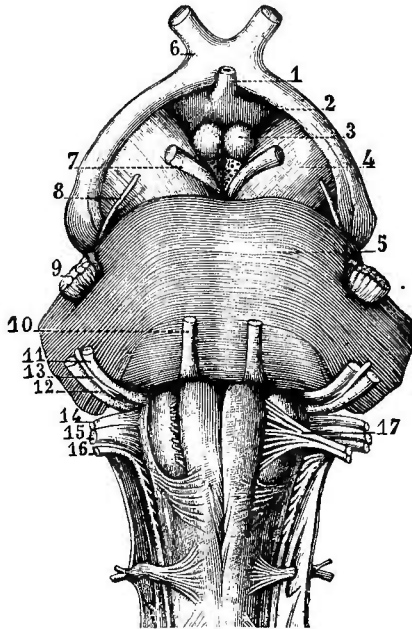

FIG. 31.—*Optic tracts, commissure, and nerves.* (Hirschfeld.)

- 1, infundibulum ; 2, *corpus cinereum* ; 3, corpora albicantia ; 4, *cerebral peduncle* ; 5, *tuber annulare* ; 6, *optic tracts and nerves, decussating at the commissure, or chiasm* ; 7, *motor oculi communis* ; 8, *patheticus* ; 9, *fifth nerve* ; 10, *motor oculi externus* ; 11, *facial nerve* ; 12, *auditory nerve* ; 13, *nerve of Wrisberg* ; 14, *glosso-pharyngeal nerve* ; 15, *pneumogastric* ; 16, *spinal accessory* ; 17, *sublingual nerve*.

pierces the sclerotic and choroid coats of the eye, about one tenth of an inch to the inner side of the axis of the eye, and then divides into numerous small fibrils, which appear to spread themselves out from the papilla of the retina somewhat like the spokes of a wheel.

In the accompanying diagram,<sup>1</sup> which is not given as an accurate representation of the parts, but rather as an aid to memory, and to render plain what words alone might make obscure, the fibers of the optic nerve are seen to enter the re-

spheres of the cerebrum ; the *inter-retinal fibers*, which are situated in the anterior portion of the chiasm, and connect the retina of one eye with that of the other ; the *longitudinal fibers*, which lie on the external side of each of the optic tracts, and connect the retina with the cerebral hemisphere of the same side ; and, finally, the *decussating fibers*, which pass through the center of the optic chiasm, and serve to connect the retina of each eye with the opposite cerebral hemisphere.

The *optic nerve* proper arises from the anterior part of the optic commissure and enters the optic foramen, in company with the *ophthalmic artery*, being surrounded by a tubular process of dura mater, which, as the nerve enters the orbit, subdivides and forms both the sheath of the nerve and the perosteum of the orbit. The nerve

<sup>1</sup> After Weber, of Darmstadt. (See page 105.)

tina at the point designated by the letter P, which is called the *papilla*, since, at this point, the retina is slightly raised above the remaining portion. This papilla is not in the exact center of the retina, since that point is reserved for the *macula lutea*, in the center of the so-called "yellow spot of Sömmering," where the most exact vision of external objects is ob-

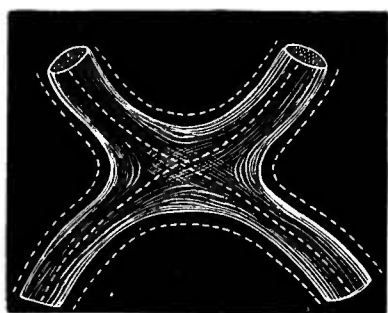

FIG. 32.—Diagram of the decussation at the optic commissure. (After Flint.)

The dotted lines show the four directions of the fibers.

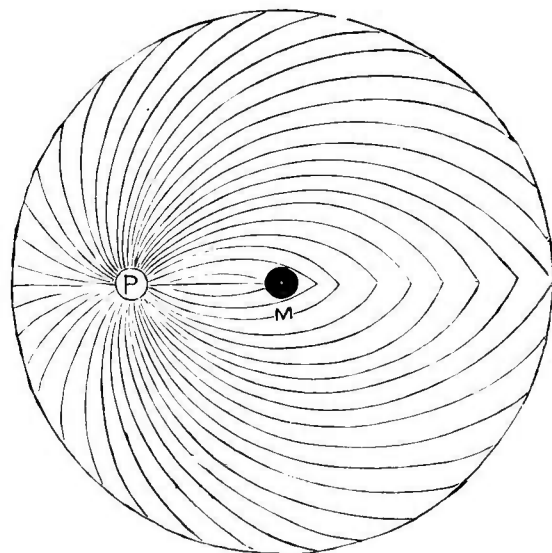

FIG. 33.—A diagram to show the course of the optic fibers in the retina. (After Weber.)

P, the *papilla*, where the optic nerve enters ; M, the *macula lutea*.

tained ; but it is placed to the *inner side of the center*, and nearly on the same level with the yellow spot. It will be seen that those nerve fibers which are distributed to the *yellow spot* of Sömmering are directed outward in a nearly straight line from the papilla, as are also those which supply the part internal to the papilla ; but that, in order to avoid crossing the yellow spot, the fibers are compelled to pass in a more or less curved direction to the other parts of the retina, whereas, if the papilla were in the exact center, the fibers of the optic nerve would probably have been straight, and arranged as the radii of a circle. This arrangement of the optic fibers differs from that described by some of the text-books on physiology, one of which, to my knowledge, states that they are arranged as a plexus, and that the frequent inosculation gives a peculiar "net-like" appearance to the

optic fibers.<sup>1</sup> Probably the fact that the nerve fibers lose their sheaths as soon as they enter the retina, and thus, unless they be previously stained, afford some difficulty in tracing them, explains the error in description.

REFLEX ACTS EXCITED BY THE OPTIC NERVE.

The optic nerve differs from the olfactory nerve in one important respect, viz., in its power of conveying impressions which create reflex muscular movements.<sup>2</sup> The motions of the iris are always influenced by the amount of light which enters the eye, and which thus affects the optic nerve filaments. When the optic nerve is divided, the *pupil immediately contracts*, unless the third cranial nerve, which controls its movements, is also severed, when the iris fails to be so affected.<sup>3</sup> In rare cases of disease, where the sight of one eye has been destroyed by some lesion of the optic nerve, the pupil of the affected eye will be found to move in unison with the uninjured eye ; but this effect is to be attributed to a motor impulse created by the influence of light upon the retina of the normal organ. In some cases also, where the tissue of the hemispheres has undergone changes which render the perception of objects impossible, the pupil may still be seen to respond to the variations of the quantity of light which enters the chamber of the eye ; thus showing that the *optic nerve alone* is required to create the reflex act upon the pupil through the third nerve, irrespective of the brain.

In addition to the power of the optic nerve to cause changes in the pupil, there is still another form of reflex act which deserves notice, viz., its power of producing contraction of the *orbicularis palpebrarum* muscle. This is perceived when an excessive quantity of light renders the effect upon

<sup>1</sup> Carpenter, *op. cit.*

<sup>2</sup> Carpenter, *op. cit.* (It is a question if *fainting* and *vomiting* can not be often justly regarded as reflex muscular acts, dependent upon the sensations perceived through the olfactory nerve.)

<sup>3</sup> Doubtless on account of the simultaneous division of sympathetic nerve fibers, which are probably derived from the fifth nerve ; these accompany the optic nerve and thus control the dilating fibers of the iris.

the retina one of pain, or when objects to be perceived are brought into too close proximity to the eye. Thus, in photophobia, the peculiar half-closed condition of the eye is not purely a voluntary act, as the eye is, at the same time, rolled upward and inward to a much greater extent than can be performed in response to a merely voluntary effort.

The act of *sneezing* may often be excited by the visual sense, when a sudden exposure of the eyes to a strong light occurs. That this reflex phenomenon is due to the excitation of the optic, and not to the olfactory nerve, is proven by the fact that, unless the *light be seen*, the attack of sneezing does not take place.

#### DECUSSATION OF THE OPTIC FIBERS.

The object of the decussation of the fibers of the optic nerve has been explained by Wollaston,<sup>1</sup> Mayo,<sup>2</sup> and others, as an arrangement on the part of Nature to have the fibers, which spring from each optic ganglion, distributed to the corresponding side of each retina; the *right optic ganglion* being thus associated with the *outer portion* of the retina of the *right eye* and the *inner portion* of the *left eye*, while the *left ganglion* is distributed to the *outer portion* of the *left eye* and the *inner portion* of the *right eye*. If this be demonstrated as true, each optic ganglion must perceive objects on the side opposite to it; since the images of things seen by the retina must fall upon the outer side of the left eye, when placed upon the right side of the eye, and vice versa.<sup>3</sup>

A similar decussation of nerve fibers is known to exist in both the posterior horns of the spinal cord and also in the anterior pyramids of the medulla oblongata; and the same arrangement in the optic nerves, which are known to be of the greatest value in preserving a *harmony of motion* throughout the body, may be for the object of bringing the visual impressions into a more direct and proper accord with the motor

<sup>1</sup> "Philos. Trans.," 1824.

<sup>2</sup> See Carpenter's "Physiology."

<sup>3</sup> See bearing of this arrangement on diagnosis of cranial tumors, later on in this chapter.

apparatus. In support of this view, it is found that in the invertebrate animals, where the optic fibers do not decussate, no decussation of fibers exists in the general motor system.

In some animals, where the two eyes have an entirely different field of vision, the decussation of the fibers from each optic ganglion is found to be complete,<sup>1</sup> the longitudinal set being absent, and the whole of the fibers from each ganglion

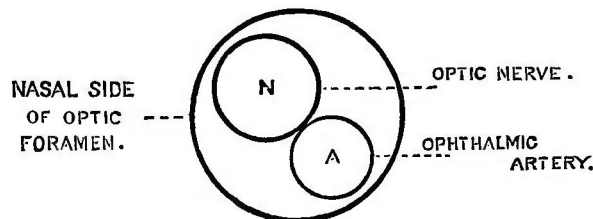

FIG. 34.—Relation of nerve and artery in the optic foramen.

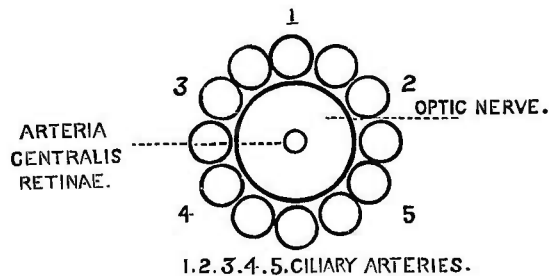

FIG. 35.—Relations of optic nerve to vessels in the orbit.

passing into the opposite eye. This arrangement can be perceived in almost all of the bird species<sup>2</sup> and in some of the osseous fishes.

#### RELATIONS OF OPTIC NERVE IN THE ORBIT.

The *relations* of the optic nerve to *blood-vessels* may have often a bearing upon vision. It passes through the optic

<sup>1</sup> The decussation of the fibers of the optic nerve seems also to be influenced largely by the extent of the field of vision which can be covered by both eyes simultaneously. The bundle of decussating fibers differs, in its relative size, from the bundle of non-decussating fibers, in different animals, who possess a stereoscopic perception of objects (their vision being binocular); and the extent of the field of binocular vision seems to explain this fact. It is said that certain birds (as the hawk, for example) have an additional power of binocular vision afforded them by means of two maculæ luteæ in each retina; so that, having two spots of distinct vision in each eye, the two eyes can the more readily focus suddenly upon any object.

<sup>2</sup> Solly, "The Human Brain" (Am. edition).



foramen in company with the ophthalmic artery, and is surrounded, for the balance of its length, by the ciliary arteries, which lie in close relation with it. It is also *pierced* by the *arteria centralis retinae*, which is thus enabled to reach the papilla of the retina, and, from that point, to ramify throughout that membrane.

It can be readily understood, therefore, how liable would be any vascular growth within the orbit to press upon the fibers of the optic nerve, or to create sympathetic changes in the vessels of the retina itself; while, as an anatomical fact, the enormous collateral circulation which exists on account of the frequent anastomosis in this region, renders such vascular growths within the orbit by no means uncommon.

#### ANATOMICAL DEFECTS OF VISION AND THEIR CONSEQUENCES.

A ray of light falling upon the retina strikes the expansion of the fibers of the optic nerve, and creates what may be called a *sensation* of light. What this sensation is, it is not within the province of this work to discuss, nor is it possible, from our present enlightenment, to explain how the brain transforms impressions, received from the fibers of the different nerves of special sense, into an actual recognition of either smell, sight, taste, or hearing. This should not deter us, however, from carefully studying all the mechanical ingenuity which Nature has shown in the arrangement of certain parts, or from attempting to interpret her aims and purposes when any such subject of inquiry seems to be presented.

There are certain practical points pertaining to the mechanism of vision concerning which every physician should be intelligent; since a recognition of existing optical defects and their bearings upon health will often enable the medical adviser to guide aright those consulting him, when otherwise serious consequences might follow the very lack of this practical knowledge.

The most common optical defects<sup>1</sup> are, undoubtedly, *hyperopia*, or far-sightedness; *myopia*, or near-sightedness;

<sup>1</sup> Bowman and Todd, "Physiological Anatomy."

and *astigmatism*, or imperfect perception of objects in certain meridians of vision.

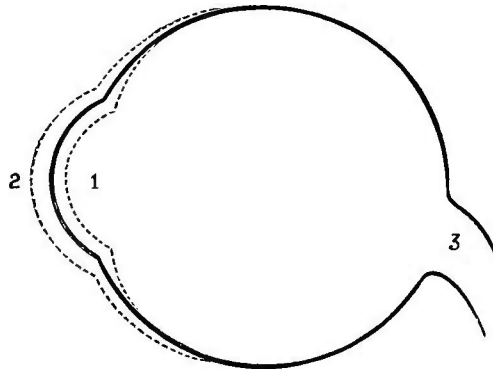

FIG. 36.—Diagram to illustrate congenital or acquired defects in the antero-posterior diameter of the eye. The black line represents the normal line of the eye. No. 1 represents the hyperopic eye; 2, the myopic eye; 3, the optic nerve.

The first of these conditions indicates, as a rule, a congenital or acquired *diminution* in the *antero-posterior axis* of the eye. Thus, as age advances, the eye either naturally becomes flattened, or the ability to accommodate for distance becomes impaired, and vision necessarily becomes hyperopic; but, in many cases, children are born with this deformity, which often goes too long unrecognized. Were Nature not able to compensate for this abnormality by means of the ciliary muscle, which, by altering the shape of the crystalline lens of the eye, is enabled to increase its convexity, and thus artificially to focus near objects, such cases would be immediately made known by the inability of the patient to read or even to see near objects with distinctness. But such cases go on from year to year, struggling, with the aid of this muscle, to see, and thus wearing out their vital energy; trying to excel in their studies, only to fail from the fatigue which attempts at study bring about, which they themselves or their parents can not explain, and which often causes them to incur bodily chastisement; and seeking, as a relief, out-of-door amusements, in which they usually excel, since little muscular effort is required to perceive objects at a distance.

<sup>1</sup> Foster, Volckers, Hensen, and Hock claim that the increased convexity of the lens is due to the relaxation of the suspensory ligament, thus allowing the lens to bulge forward from its own elasticity.

How cruel and injurious to health must be compulsory education to such a one, till, by the aid of properly adjusted glasses, reading becomes a pleasure; study no longer a burden, but a joy; and nervous headache, throbbing in the orbit, double vision, and other evidences of nervous prostration, are numbered as among the things of the past!<sup>1</sup>

On the other hand, *myopic patients* can not see objects at a distance, since their eyes are too convex; but only when placed close to the eyes are the beauties of outline fully perceived, and distinct vision rendered possible. Out-of-door exercise is, to children of this type, a burden and a disappointment, since they can not enjoy Nature in her most beautiful aspects, nor indulge in sports without danger, which to the healthy child, with perfect vision, is harmless. Such children seek enjoyment in books, the contents of which can be seen by them and easily read; the fields are discarded for the parlor; the enforced retirement is wrongly construed by the parents and physician as an indication of precocity and a taste above that of the romping child; the health is imperiled, the intellect weakening by undue strain, and the mind made one of ideals rather than of realities, since pictures and book representations are to them Nature in her true aspects.<sup>1</sup>

*Astigmatism* is a condition due to the fact that either the surfaces of the cornea or of the crystalline lens are not of the *same curvature*, but are more convex in some portions than in others, or in the perpendicular meridian than in the horizontal. This abnormality of contour causes a distortion of the image of objects in the field of vision. If black lines, of equal width, be drawn parallel with each other, and several placed perpendicularly on one portion of a page and several horizontally on another portion of the same page, such an eye will see one or the other set either less distinctly as to outline, or one set will appear darker than the other.

Almost all eyes are slightly *astigmatic*, and generally with the greatest convexity in the vertical meridian. And the same irregularity in lenses can be demonstrated by attempting to

<sup>1</sup> See article by Dr. Loring, "Harper's Mag.," August, 1879.

focus light from a luminous point, when the image will be found to be radiated, instead of a perfect circle, as it should be from a perfect lens.

In choosing spectacles, for the purpose of correcting errors of the eye, it is of great consequence not to make an *over-compensation*; for this has a tendency to increase the defect, besides occasioning great fatigue in the employment of the sight.

From observations previously made as to the mechanism of the action of the ciliary muscle upon the lens, by which vision is accommodated for near objects in case the eye is normal, it may be understood why all power of accommodation of vision is lost after the operation for cataract.

A TEST FOR MYOPIA AND HYPEROPIA.

**E B F P T Z D**  
**D L T Z F P E**  
**B E P F Z T L**

The normal eye should read letters of this kind and size at twenty feet. Vision is then said to be normal. If the eye can not do this at twenty, but can at ten feet, then vision is ten twentieths, or one half of the normal, and so on.

To test the eyes, place the letters at twenty feet distance, in a good light. Try first one eye, and then the other.

Any eye which can not read the letters fluently at this distance deviates from the normal standard, and should have a thorough examination.

To test for the defect which has been mentioned in the foregoing remarks as astigmatism, place the drawing, show-

ing parallel lines arranged vertically and horizontally, at fifteen or twenty feet, and be sure to test each eye separately.

## A TEST FOR ASTIGMATISM.

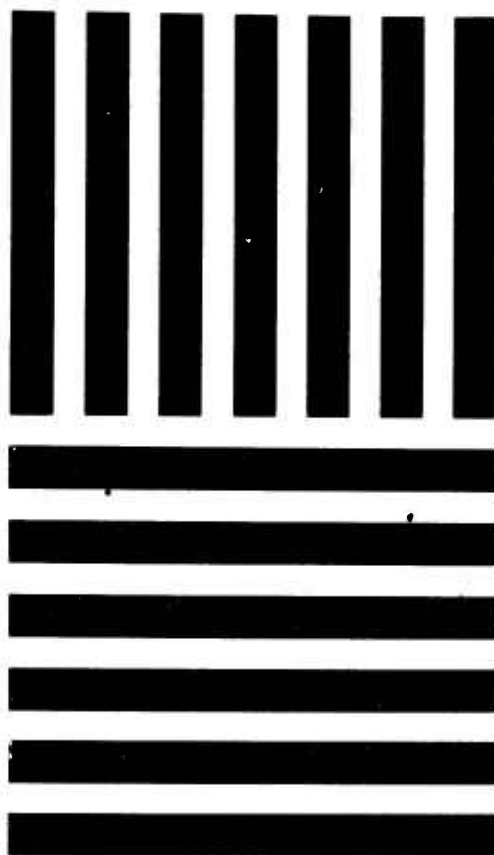

These lines should appear equally distinct ; that is, those running vertically should look as black and clearly defined as those which run horizontally, and vice versa. If, however, there is any difference between them as to shade of color or distinctness of outline, the eye is astigmatic, and the greater the difference, the greater the degree. Such an eye as this requires peculiar glasses, which can only be determined by a careful examination, and which have to be selected to fit each case. It may be that a person is not astigmatic for vertical or horizontal lines, but is for those running obliquely. To test this, turn the drawing so that what are ordinarily the vertical lines shall run obliquely, say, at an angle of forty-five degrees.

If, now, this were all, it would be a simple matter for the

parent or teacher to determine just what children needed a careful examination, but, unfortunately, there are a large number of children who, as has been already explained, have a deficiency of optical power, but who can, nevertheless, neutralize this deficiency by an effort, so that they can see at as great a distance and as clearly as those who have normal eyes. These are those who most suffer from headache, and from all the ills of a nervous nature which have been detailed in the foregoing remarks. The only satisfactory way out of the difficulty would appear to be, that every child should have the optical condition of the eye and the amount of vision determined, before school life begins, by some competent person trained in the methods of making these examinations.

#### CHANGES IN THE PUPIL.

The pupil of the eye may be seen to dilate when distant objects are to be perceived, and to contract when near objects are inspected, since, by so doing, the amount of light which enters the eye is regulated, and the distinctness of the image is thus increased.

Irritation of the optic nerve, by an excessive quantity of light, also creates contraction of the pupil; while the same condition may be the result of simply turning the eyeball inward.<sup>1</sup>

In the early stages of anæsthesia<sup>2</sup> from chloroform, in alcoholic excitement, in poisoning from morphia, physostigmin, and some other drugs, and, finally, in deep slumber, the pupils are found to be *contracted*.

*Dilatation* of the pupil may be dependent upon a dim light, an attempt to view distant objects, emotional excitement, the latter stages of anæsthesia from chloroform, and from belladonna poisoning and that of drugs of similar action; while it may also occur in all conditions creating an

<sup>1</sup> "I may here say that small and unequal pupils in a person of middle age, from twenty-five to sixty, should lead to an inquiry into the possible existence of one of three morbid states, viz.: paralytic dementia (or general paralysis), sclerosis of the posterior columns, and cardiac or aortic disease (intra-thoracic disease)." (E. C. Seguin.)

<sup>2</sup> Mich. Foster, "Text-Book of Physiology."

excess of aqueous humor within the eye, and during dyspnoea and excessive muscular exertion.

The mechanism of the action of the pupil will be more properly considered under the description of the third nerve, which furnishes it with motor power.

#### VISUAL SENSATIONS AND THEIR MODIFICATIONS.

Shadows thrown upon the retina are perceived as specks in the vision, the so-called *musca volitantes*.<sup>1</sup> They may arise from tears upon the cornea, a temporary unevenness of the cornea after the eyelid has been pressing upon it, imperfections of the lens or its capsule, and from shadows produced by the margin of the iris, especially if it be imperfect.

They are distinguished chiefly by their almost continual change in position, when the head is moved up and down, and by a tendency to entire disappearance when an effort is made to fix the vision upon them.

That point on the retina, the *papilla*, where the optic nerve pierces it, is called the "blind spot,"<sup>2</sup> since no sensations of light can be perceived in that locality

In that portion of the retina, the "macula lutea," where the images to be perceived by the optic nerve fall most directly, and where most of our visual perceptions are therefore gained, a markedly *yellow pigment* exists, which tends to absorb some of the greenish-blue rays of light; hence what we perceive as *white* in color is, in reality, more or less yellow.

When pressure is forcibly exerted upon the eyeball, the whole retina speedily becomes insensible to light. This fact has been explained as the result of a loss of the conductive power of the nerve structures. Exner, however, endeavors to use this fact as the basis of an argument to prove that the sensation of light is the result of some substance (as yet undetermined) within the retina, whose *production is temporarily arrested* by any pressure upon the eye which is sufficiently forcible to occlude the vessels of the retina, and thus to interfere with its nutrition.

<sup>1</sup> Bowman, "Phys. Anat."

<sup>2</sup> Helmholtz, "Phys. Optik."

## THE PERCEPTION OF COLOR.

The subject of *color blindness*, which is to-day assuming great importance, naturally suggests to the inquiring mind—by what anatomical arrangement are the optic nerve fibers

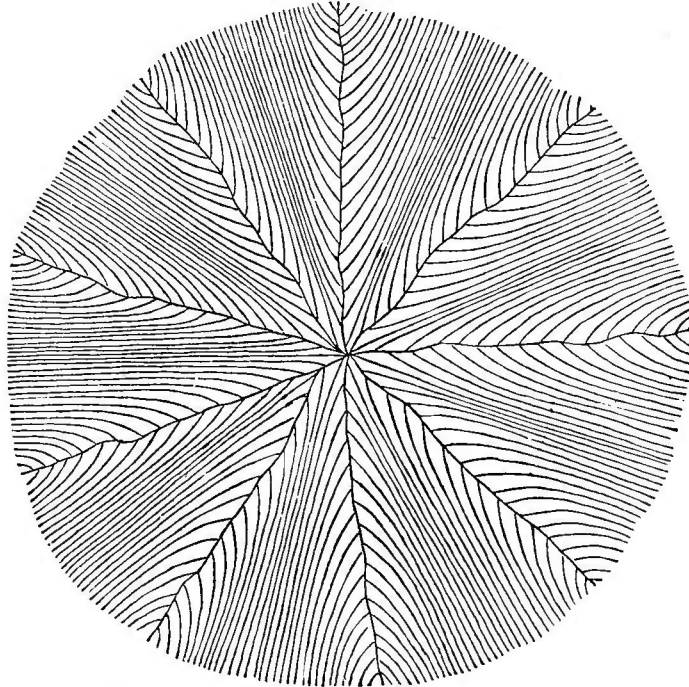

FIG. 37.—Crystalline lens, anterior view. (Babuchin.)

informed, through the aid of the coats of the retina, of the perception by that membrane of the color of images?

That the retinae of animals possessed color was first noticed by Krohn, as early as 1839; but the matter was not regarded as of any physiological importance until Boll, in 1876, announced that the retina of all vertebrated animals possessed a purplish color, which faded in the light, but which darkness restored. He concluded that the color must be largely concerned in the act of vision.<sup>1</sup>

The subsequent experiments of Kühne upon this subject seem to have partially verified this discovery, but exactly what

<sup>1</sup> A very interesting article, by my friend Dr. Ayres, of this city, appeared in the "New York Med. Jour." (December, 1880), in which the physiological action of the *visual purple* was discussed; its function is here stated to be a *photo-chemical one*, designed to *accommodate vision to different degrees of light*, since it is capable of changing and regaining its original color when circumstances demand it (an intensity of light or an approach to darkness causing rapid effects upon it).



its function is may yet be considered a subject of investigation. A prominent author says of this matter: "It is very tempting to connect this visual purple with color vision; but

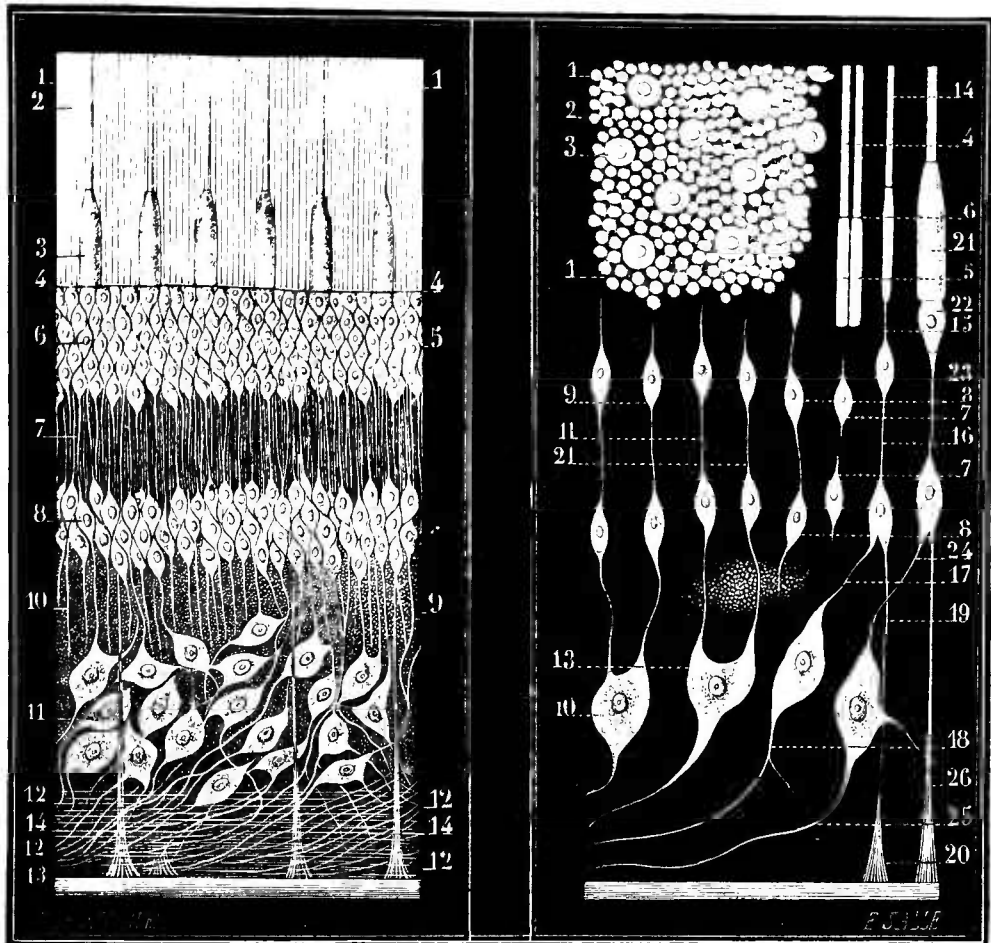

FIG. 38.—A. *Vertical section of the retina.* B. *Connection of the rods and cones of the retina with the nervous elements.*  
(H. Müller.) (Sappey.)

- A. 1, 1, layer of rods and cones; 2, rods; 3, cones; 4, 4, 5, 6, external granule layer; 7, inter-granule layer (cone-fiber plexus); 8, internal granule layer; 9, 10, finely granular gray layer; 11, layer of nerve cells; 12, 12, 12, 12, 14, 14, fibers of the optic nerve; 13, membrana limitans.
- B. 1, 1, 2, 3, rods and cones, front view; 4, 5, 6, rods, side view; 7, 7, 8, 8, cells of the external and internal granule layers; 9, cell, connected by a filament with subjacent cells; 10, 13, nerve cells, connected with cells of the granule layers; 11, 21, filaments connecting cells of the external and internal granule layers (12 is not in the figure); 14, 15, 16, 17, 18, 19, 20, 22, 23, 24, 25, 26, a rod and a cone, connected with the cells of the granule layers, with the nerve cells, and with the nerve fibers.

we know that our color vision is most exact in the *fovea centralis*, where the retina consists of cones alone, which are destitute of this visual purple.”<sup>1</sup>

<sup>1</sup> Mich. Foster, *op. cit.*

While no positive statements can as yet be made as to the function of that layer of the retina known as "the rods and cones of Jacob," still authorities seem inclined to attribute to the *cones*, rather than to the rods, the power of perceiving color. It is known that these cones are absent in the retina of nocturnal animals; while, in the eyes of birds and reptiles, globules containing color are found within the cones. Moreover, the "fovea centralis" in the human eye is destitute of rods.

To explain our perception of color, the hypothesis was first made by Young that there existed in the retina the power of perceiving *three distinct color sensations*, which, being parts of the spectrum, could, by a proper admixture of certain proportions of each, produce white; he further supposed that there existed *three distinct sets of nerve fibers*, each set being sensitive to a primary color sensation, viz., to wave lengths of a certain length. Helmholtz has done much to bring this theory to notice, so that the theory is known now as the "Young-Helmholtz theory," rather than by the name of the originator of the hypothesis alone. The fact that the most careful microscopical examinations of the retina fail to discover the existence of sets of fibers, which differ in their anatomical construction, seems to place this theory rather on the basis of a pretty hypothesis than that of an acknowledged fact.

Hering and Aubert<sup>1</sup> have discarded the Young-Helmholtz theory, however, and have attempted to explain the perception of color by a process of *disintegration*, in one set of colors, and, in another, by a process of *assimilation* of a property of the retina, which is denominated "*visual substance*."

All persons vary much in their power of discriminating and appreciating color;<sup>2</sup> but only those can properly be said to be "color blind" who regard colors as similar which to most people would be glaringly distinct. Thus, red and green

<sup>1</sup> "Physiologie der Netzhaut," 1865.

<sup>2</sup> Seebeck, Wartmann, Müller's "Physiology" (Baly's edition).

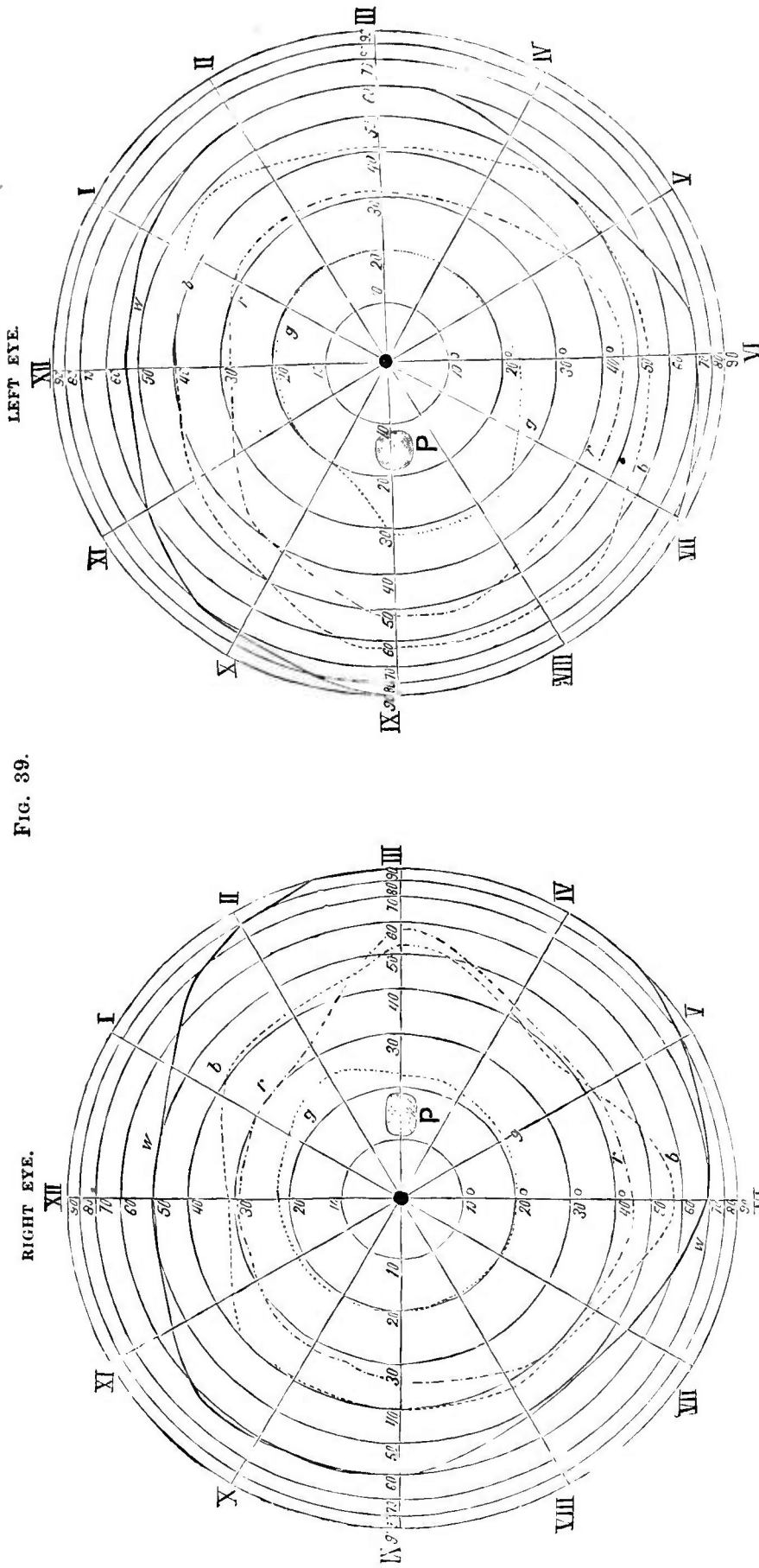

FIG. 39.

In this diagram, the results of the researches of the German investigators have been so clearly defined by Dr. Hirschberg as to simplify the examination of the retina, and enable any deviation from its normal condition to be perceived and recorded.

— stands for the limit of vision for white objects.  
 - - - - - stands for the limit of vision for blue objects.  
 . . . . . stands for the limit of vision for green objects

P stands for the papilla of the retina.  
 The letters on the color lines indicate the color which each represents.  
 The center of the diagram, from which the lines diverge, corresponds to the *macula lutea*, the center of the "yellow spot of Sommering"; while the numbers on the lines are placed at equal degrees from the center, to enable the oculist to designate the exact situation of *special points of interest* pertaining to any ophthalmoscopic examination.

are commonly mistaken for each other; while purple and blue, red and brown, and brown and green, are often detected from one another with difficulty, if at all.

#### APPARENT VISION OF OBJECTS NOT REALLY SEEN.

Any stimulation of the optic nerve or of the retina, if sufficiently intense, may give rise to certain sensations, which are mistaken for actual vision. As examples of this fact, a blow in the eye or on the back of the skull will often make the injured person "see stars" or have flashes of light apparently cross the field of vision.

Foster<sup>1</sup> mentions a case, where, by a voluntary compression of the eyeball by the orbicularis palpebrarum muscle, gorgeous visions of flowers and landscapes could be produced.

#### EFFECT OF OPTIC NERVE ON COÖRDINATION.

The optic nerve may become a means of vertigo, when objects are caused to pass rapidly before the field of vision, as in viewing a waterfall, being rapidly whirled, etc. This subject, however, will be more fully considered, with points of interest pertaining to the auditory nerve, since Menière's malady is more often dependent upon disease of the acoustic apparatus.

Goltz<sup>2</sup> has shown, by experiments upon birds whose heads were artificially secured in an abnormal position, that they at once become incapable of orderly flight, thus further confirming the apparent connection between the special sense of sight and those muscular movements which require the exercise of the power of coördination.

#### EFFECT OF THE OPTIC NERVE ON THE LACHRYMAL APPARATUS.

The contraction of the orbicularis muscle tends to press the tears, which the lachrymal canals contain, onward toward the nasal duct; and they dilate to receive a fresh quantity during the relaxation of this muscle. Thus the act of *wink-*

<sup>1</sup> Taylor's "Scientific Memoirs."

<sup>2</sup> *Op. cit.*

<sup>3</sup> Pflüger's "Archiv," 1873, as quoted by Foster.

*ing*, which usually precedes any special attempt to see with distinctness, by calling the orbicularis palpebrarum muscle into play, assists in cleansing the eye of any excess of tears. It has been stated by Demtschenko,<sup>1</sup> that, during the closure of the eyelid, a peculiar arrangement of the muscular fibers tends to keep the lachrymal canals open, and thus to act as an aid to the orbicularis muscle in its mechanical effect. In

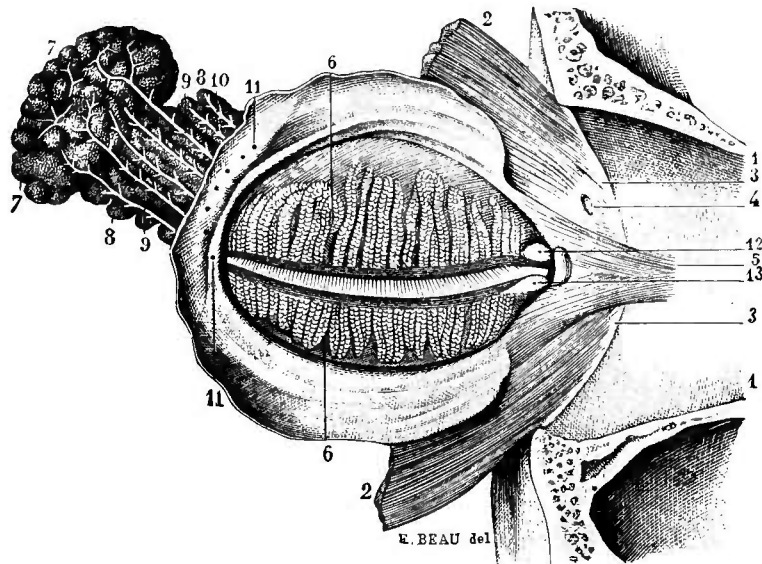

FIG. 40.—*Lachrymal and Meibomian glands.* (Sappey.)

1, 1, internal wall of the orbit ; 2, 2, internal portion of the orbicularis palpebrarum ; 3, 3, attachment of this muscle to the orbit ; 4, orifice for the passage of the nasal artery ; 5, muscle of Horner ; 6, 6, posterior surface of the eyelids, with the Meibomian glands ; 7, 7, 8, 8, 9, 9, 10, lachrymal gland and ducts ; 11, 11, openings of the lachrymal ducts.

addition to this anatomical device, the alternating pressure of the *tendo oculi* upon the lachrymal sac tends to act as a pump, and thus to draw the tears from the globe of the eye.<sup>2</sup>

The flow of tears, while constant in a state of health, may be greatly increased by a reflex act. Such exciting causes as a stimulation of the nasal mucous membrane, the conjunctiva, the optic nerve, and the tongue, and, more forcibly, the effect of the emotions, are commonly perceived. It is said that *venous congestion of the head* is frequently manifested by an excessive production of tears.<sup>3</sup> The different efferent

<sup>1</sup> Hoffman und Schwald's "Bericht," 1873.

<sup>2</sup> Darling and Ranney, "Essentials of Anatomy," 1880.

<sup>3</sup> Mich. Foster, *op. cit.*

nerves, which exert a controlling influence upon the lachrymal apparatus in response to the exciting causes above mentioned, include the lachrymal and orbital branches of the fifth cranial nerve and filaments of the cervical sympathetic.<sup>1</sup>

Many of the facts pertaining to the optic nerve may, by the skillful physician, be made useful in his daily practice as guides to diagnosis ; while others are given as explanations of many phenomena which often occasion alarm to those not familiar with the mechanism of their production.

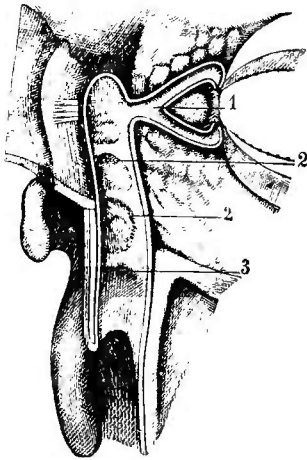

FIG. 41.—*Lachrymal canals, lachrymal sac, and nasal canal, opened on their anterior portion.* (Sappey.)

- 1, walls of the lachrymal passages, smooth and adherent ; 2, 2, walls of the lachrymal sac, presenting delicate folds of the mucous membrane ; 3, a similar fold belonging to the nasal mucous membrane.

#### CLINICAL POINTS AFFORDED BY MEANS OF THE OPTIC NERVE.

The optic nerve has of late acquired an importance to the oculist, which is based upon the physiological distribution of the nerve, but which has to the specialist more than a theoretical value, since, by means of the knowledge afforded, the diagnosis of the *existence of cranial tumors* pressing upon the nerve, or of *local pressure* from *inflammatory exudations*, may be not only positively made out, but the exact situation of the pressure often determined.

The hypotheses of Wollaston and Mayo have been so far confirmed by later investigators, that it may now be quite positively stated that the *exact half* of each retina derives its power of vision from one optic tract, and the other half from the opposite tract. It has been proven that the *longitudinal fibers* of each optic tract supply the sense of vision to the *outer* or *temporal side* of each retina, and that the *decussating fibers* of each optic tract supply the *inner* or *nasal side* of each retina. When, therefore, the optic tract of either side is pressed upon, so as to affect the entire thickness of the

<sup>1</sup> See experiments of Herzenstein, Wolferz, Reich, and others.

nerve, and thus to interfere with the action of *all the fibers* which that tract contains, the temporal side of the retina of that eye which corresponds to the optic tract affected and the nasal side of the retina of the opposite eye will be rendered blind, or will be impaired in exact proportion to the pressure exerted upon the optic tract. Blindness of the lateral half of the retina of either eye is termed "hemioopia" or "hemianopsia"; and this condition may affect, 1, both eyes similarly; 2, both eyes diametrically; and 3, either eye alone.

When either eye is alone affected with blindness of *one half* of the retina, it indicates that the optic nerve is pressed upon, or otherwise impaired, at a point situated *in front* of the *optic chiasm*; since, if the optic tract were the seat of the existing trouble, both eyes would be affected, as it would be almost impossible for the pressure to affect the longitudinal fibers, and still leave the decussating fibers of the tract uninjured, or vice versa. With this as a starting point in the diagnosis, we determine which half of the eye is blind, knowing that, if the nasal side be the one where vision is lost, the pressure must be on the inner side of the nerve, and, if the outer or temporal side be blind, that the outer side of the nerve is the seat of the disease which is causing the pressure. Should both sides of one eye be rendered blind, and no local cause within the eye be found to exist, then the existence of pressure anterior to the optic chiasm, of such a character that the entire nerve is destroyed or impaired, may safely be diagnosed.

Total amaurosis of one eye is frequent evidence of *glioma* or *sarcoma* within the orbit, as they are the two forms of tumors which most frequently affect that region; and the diagnosis of the presence of this cause will probably be confirmed, in case it exists, by symptoms referable to paralysis of some of the muscles of the eye, since the same pressure will be also likely to affect either the third, fourth, or sixth nerves.

The most common form of "hemianopsia"<sup>1</sup> met with,

<sup>1</sup> A synonym for *hemioopia* in its generally accepted sense, but a better term, since it means blindness of half of the retina, while the former means only half vision.

as the result of the pressure of cranial tumors, is where the temporal half of one eye and the nasal half of the opposite eye are rendered blind. This clinical fact is supported by the anatomical distribution of the fibers of the optic tract, which, as before stated, supply the temporal side of the eye of the same side and the nasal side of the eye of the side opposite. When this condition is met, we know, therefore, that the *optic tract* must be pressed upon, and that the pressure is being exerted upon the side corresponding with the eye which is blind in its temporal or outer half.

In those uncommon cases where the inner or *nasal half* of each retina is deprived of sight, the existence of pressure at the anterior or posterior portions of the optic chiasm may be diagnosed, since the decussating fibers of each optic tract cross each other at these points only; and the nasal side of each eye being affected proves that the *decussating fibers* of each tract must be simultaneously pressed upon, without any disturbance of the longitudinal fibers.

In those cases where the outer or *temporal sides* of both retinae exhibit evidences of pressure from some cause within the cranium, the explanation of the mechanism of its production has, until of late, been involved in obscurity; but it is now explained by a curious anatomical relation between the internal carotid arteries (as they assist to form "the circle of Willis") and the optic nerve.<sup>1</sup> It will be observed, by reference to the plates of your anatomy, that the *anterior communicating artery* passes underneath the optic nerves and in front of the chiasm, while the main trunks of the carotid arteries are adjacent to the chiasm, and curl outward from nearly its central point toward its outer edge. Now, in *senile degeneration* of the vessels, the atheromatous changes in the arterial coats tend to destroy the elasticity of the vessels, and to either shorten them, or to render them less elastic, and thus, in this region, the arteries act as a gathering string around the optic chiasm, and, by pressing upon the outer portion of each tract, the longitudinal fibers of each tract are

<sup>1</sup> An explanation original, I believe, with Professor H. Knapp, of this city.



impaired, while the decussating fibers of each tract are not injured, thus accounting for the blindness of the temporal half of each retina.<sup>1</sup>

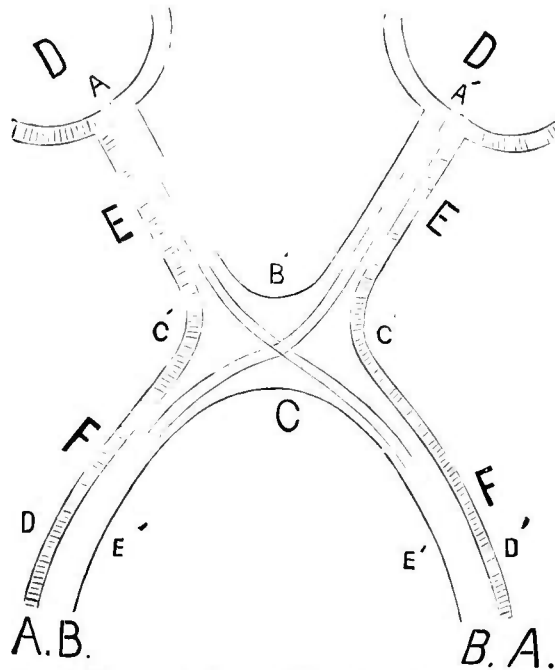

FIG. 42.—A, *Longitudinal* fibers of the optic tract (colored red on chart); B, *Decussating* fibers of optic tract (colored blue on chart); C, *Optic Chiasm*; D, *Retina* (showing nerve distribution to each half); E, *Optic Nerves*; F, *Optic Tracts*; A'—B', region where pressure may produce "hemianopsia" or "total amaurosis" of one eye; E'—D', region where pressure will result in "hemianopsia" of opposite halves of the retina of both eyes; C'—C', region where the constriction of the vessels of the "circle of Willis" will produce "hemianopsia" of *temporal half* of the retina of both eyes; B' or C, special localities where "hemianopsia" of the nasal half of the retina of both eyes will ensue from pressure; C C', B C', region which must be entirely destroyed by pressure to produce *total amaurosis* of both eyes.

If you will look at the diagrammatic picture which I now show you, it will enable you, perhaps, to better understand the mechanical explanations of the various conditions which may result from pressure upon the optic tracts, or upon the optic nerves, if in front of the chiasm. You will perceive that the longitudinal fibers of each tract, which I have colored red,<sup>2</sup> if traced to their distribution, supply the outer half of the eye of the same side, while the decussating fibers of each tract, which I have colored blue,<sup>3</sup> pass to the inner or nasal

<sup>1</sup> It might be possible for two tumors, each so situated as to affect the *outer side* only of each optic tract, to produce this condition; but the probability of such a condition ever existing in any special case would be extremely small.

<sup>2</sup> Shaded dark in figure, but colored for class demonstration.

<sup>3</sup> Not colored in plate, but represented by decussating lines. The presence of color for demonstration to large classes is oftentimes of great assistance.

side of the opposite eye. You can, therefore, see the reason for the following summary of the guides afforded by partial blindness of the retina, in making a diagnosis of the situation of cranial tumors.

1. *Total amaurosis of one eye* indicates pressure between the chiasm and the eye affected, which has destroyed the conducting power of both the decussating and longitudinal fibers of the nerve.

2. *Total amaurosis of both eyes* seldom occurs in tumor;<sup>1</sup> but, if it be dependent upon a tumor, it must affect the chiasm itself, and have completely destroyed it.

3. A loss of vision in the *nasal half* of both eyes indicates the existence of a tumor, either in front of or behind the optic chiasm, which affects only the decussating fibers of each tract.

4. A loss of vision in the *nasal half* of one eye and the *temporal half* of the other, indicates pressure upon the *optic tract* upon the side where the temporal half of the retina is destroyed.

5. A loss of vision in the *temporal half* of both eyes indicates *senile degeneration* of the vessels forming the "circle of Willis," which are creating pressure upon the outer side of each of the optic tracts.

The optic nerve may be the guide to many diseased conditions of parts more or less distant. The condition of *hyperæsthesia* of the retina, to which its terminal filaments are distributed, may be indicative of congestive diseases of the brain; of the development of cerebral tumors; and of certain mental diseases (as prominently shown in ecstasy, hypochondria, etc.). It also occurs in hysteria, chorea, chronic alcoholism, narcotism, the inhalations of certain toxic gases, etc. It may frequently be the evidence of some local condition of the optic apparatus; hence we meet it in cases of congestive and inflammatory conditions of the retina; also where an excessive amount of application of vision has been demanded, in disease and atrophy of the nerve itself, and in slight compression of the nerve from local causes.

<sup>1</sup> This condition is more commonly due to atrophy of the optic nerve and to glaucoma.

When the optic nerve filaments become *anaesthetic*, sight is impaired in the exact ratio of the loss of sensibility: hence we speak of the condition of "*amblyopia*," when the sight is partly destroyed by this condition, and of "*amaurosis*" when the sight is entirely destroyed.

We may consider a loss of sensibility of the optic nerve filaments as a symptom of the gravest import, since it indicates either some disease of the brain or some advanced changes of the nerve itself. The *brain conditions* which are most liable to produce this condition are as follows; neuroretinitis, which may follow cerebral hæmorrhage, cerebral softening, Bright's disease, lead poisoning, and syphilis; the various forms of ataxia; cerebral tumors; chronic effusion into the ventricles; and hysterical cerebral disorders.

The *local conditions* which may result in optic anæsthesia include inflammation of the retina and the adjoining structures; hæmorrhage into the retina; retinal tumors; the compression of glaucoma; pressure of tumors, in the orbit or cranium, upon the optic tracts; thickening of the meninges in the vicinity of the optic chiasm; and traumatism.

Atrophy and sclerosis of the corpora geniculata may result in amaurosis;<sup>1</sup> lesions of the cerebellum<sup>2</sup> may be accompanied by symptoms referable to the optic apparatus (probably on account of the pressure created upon adjoining regions of the encephalon); and an increase of intra-cranial pressure, from any cause, may produce retinal changes.

#### THE THIRD OR "MOTOR OCULI" NERVE.

This nerve has its apparent origin from the *inner border* of the *crus cerebri*. The deep origin of the nerve can, however, be traced to the "*locus niger*," and to a *gray nucleus* in the *floor of the aqueduct of Sylvius*, slightly below the tubercula quadrigemina.

The course of this nerve, after it escapes from the brain, is of importance, from the relations which it has with impor-

<sup>1</sup> See p. 58 of this volume.

<sup>2</sup> See p. 62 of this volume.

tant structures, and from the physiological phenomena produced by it. It pierces the dura mater opposite to the *anterior clinoid process*, in order

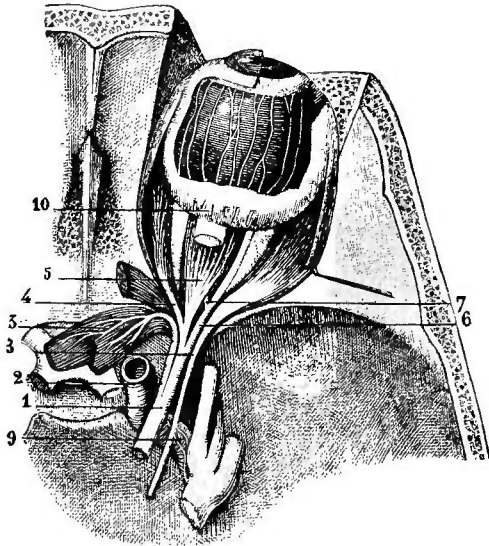

FIG. 43.—*Distribution of the motor oculi communis.* (Hirschfeld.)

- 1, trunk of the motor oculi communis ; 2, superior branch ; 3, filaments which this branch sends to the superior rectus and the levator palpebrae superioris ; 4, branch to the internal rectus ; 5, branch to the inferior rectus ; 6, branch to the inferior oblique muscle ; 7, branch to the lenticular ganglion ; 8, motor oculi externus ; 9, filaments of the motor oculi externus anastomosing with the sympathetic ; 10, ciliary nerves.

to reach the outer wall of the cavernous sinus, where it lies in close relation with the fourth cranial nerve, and the ophthalmic branch of the fifth cranial nerve, being above them both, and also with the cavernous sinus, which lies internal to it. It is in this region that the nerve is joined by filaments from the cavernous plexus of the sympathetic system.

between the *two heads of the external rectus muscle* of the eyeball, and from this point they pass onward to their respective distributions, viz., the superior branch to the levator palpebrae and the superior rectus muscles, and the inferior branch to the inferior oblique, the inferior rectus, and the internal rectus muscles, and, by a small filament, furnishing the motor root to the ciliary or lenticular ganglion of the orbit.

The third cranial nerve thus supplies *all of the muscles of the eye but two*, viz., the superior oblique and the external rectus muscles, which derive their motor power, respectively, from the fourth and the sixth nerves. It also supplies filaments to the ophthalmic ganglion (which is also called the ciliary, and the lenticular ganglion), which filaments

The nerve now passes from the cavity of the cranium by means of the *sphenoidal fissure*, having, however, divided into two branches, before its escape, called the superior and inferior.

In the sphenoidal fissure, these two branches are placed

are subsequently distributed to the *ciliary muscle* and the *iris*.

It is now claimed that the fibers of the third nerve, which pass to the aqueduct of Sylvius, decussate; and it is to this

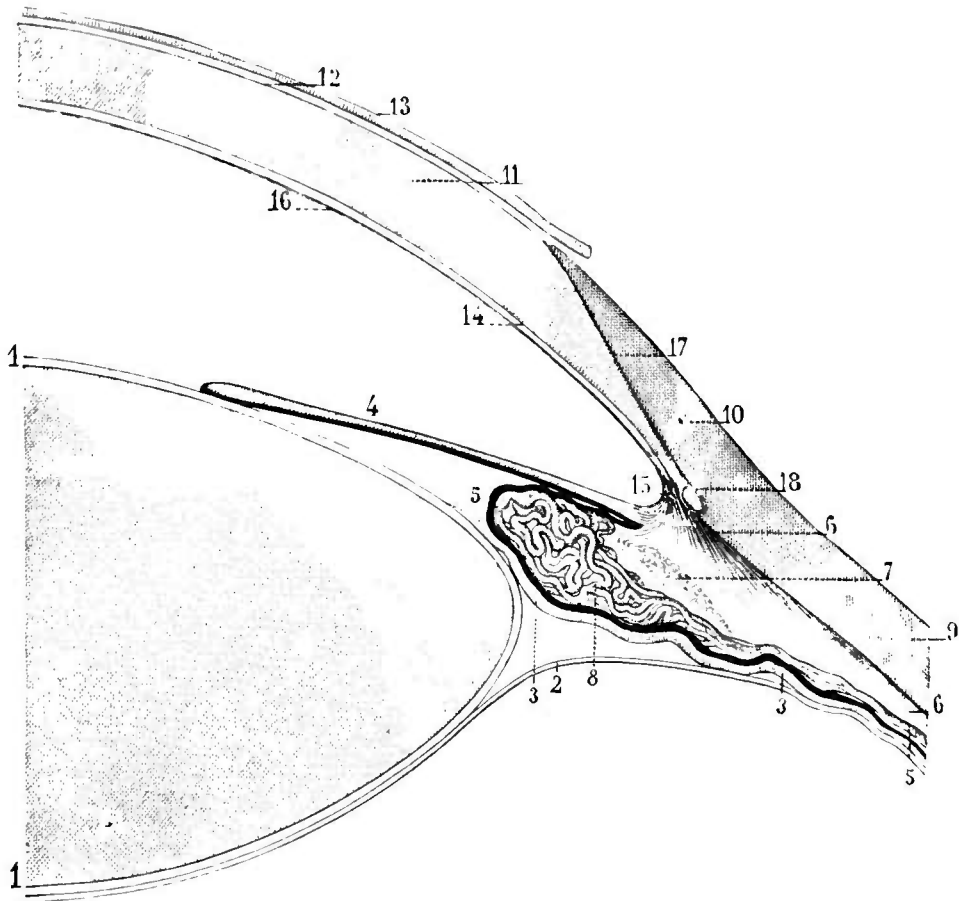

FIG. 44.—*Ciliary muscle*; magnified 10 diameters. (Sappey.)

1, 1, crystalline lens; 2, hyaloid membrane; 3, zone of Zinn; 4, iris; 5, 5, one of the ciliary processes; 6, 6, radiating fibers of the ciliary muscle; 7, section of the circular portion of the ciliary muscle; 8, venous plexus of the ciliary process; 9, 10, sclerotic coat; 11, 12, cornea; 13, epithelial layer of the cornea; 14, membrane of Descemet; 15, ligamentum iridis pectinatum; 16, epithelium of the membrane of Descemet; 17, union of the sclerotic coat with the cornea; 18, section of the canal of Schlemm.

anatomical arrangement of its fibers of origin that the effect of the pupil of one eye upon the condition of the pupil of the opposite eye is occasionally observed in disease, and that the muscles of the two eyes, as well as the iris, are thus enabled to work in perfect harmony with each other. As an example of this, it is occasionally observed that, when amaurosis affects one eye, the pupil of the diseased organ will not respond to the effect of light upon the retina of that side, but, when the

light creates a movement of the iris of the unimpaired eye, the pupil of the opposite side also responds, thus showing that reflex action is possible between the two eyes.

MECHANISM OF THE CONTRACTION OF THE PUPIL.

The mechanism of the reflex act, by which the third nerve is enabled to so affect the contraction and dilatation of the pupil as to have its varying size correspond exactly to the requirements of the retina, as regards the amount of light

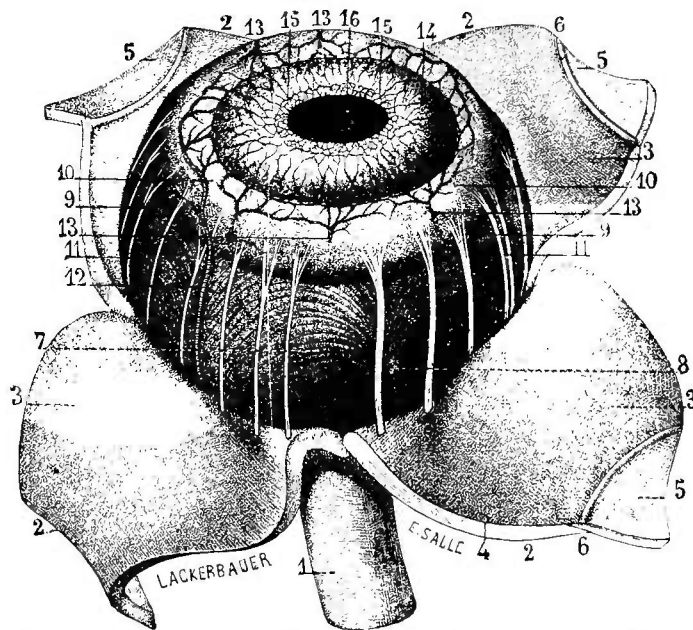

FIG. 45.—*Choroid coat of the eye and the ciliary nerves.* (Sappey.)

- 1, optic nerve; 2, 2, 2, 2, 3, 3, 3, 4, sclerotic coat, divided and turned back to show the choroid; 5, 5, 5, 5, the cornea, divided into four portions and turned back; 6, 6, canal of Schlemm; 7, external surface of the choroid, traversed by the ciliary nerves and one of the long ciliary arteries; 8, central vessel into which open the vasa verticosa; 9, 9, 10, 10, choroid zone; 11, 11, ciliary nerves; 12, long ciliary artery; 13, 13, 13, 13, anterior ciliary arteries; 14, iris; 15, 15, vascular circle of the iris; 16, pupil.

necessary for perfect vision at all times and under all circumstances, is a subject of interest to those who study anatomy from the standpoint of its physiological bearings. The optic nerve, when a person comes from darkness into the light, perceives, on account of the dilated condition of the pupil, an excess of light which at once compels the eye to momentarily close<sup>1</sup> until the pupil shall become contracted. The

<sup>1</sup> A reflex act produced through the optic nerve upon the orbicularis palpebrarum muscle.

sensation of over-stimulation created in the optic nerve by the glare of light entering the dilated pupil is carried backward to the brain, and, probably in the region of the aqueduct of Sylvius, creates a reflex act which sends motor impulses along the fibers of the third nerve to the iris, by means of the branch to the ciliary ganglion. Thus it happens that, when the eye is again opened, the sensation of distress in the optic nerve is no longer present, and the pupil is found to be contracted in a direct proportion to the amount of light which at the time exists.

REASONS FOR THE PECULIAR DISTRIBUTION OF THE THIRD NERVE.

The distribution of the third cranial nerve may suggest to the inquiring mind the following questions: "Why does

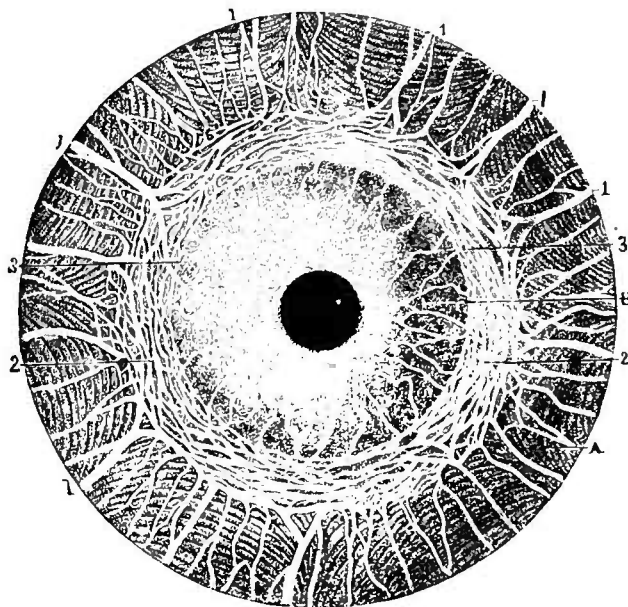

FIG. 46.—*Plexus of ciliary nerves.—Nerves of the iris.* (After Sappey.)

A, choroid; B, iris; 1, 1, 1, 1, ciliary nerves dividing at their terminal extremity into two or more branches, which anastomose to form a circular plexus surrounding the greater circumference of the iris; 2, 2, plexus formed by this anastomosis; 3, 3, nerves of the iris originating from this plexus.

Nature use three nerves to control the movements of the six ocular muscles, when she could have used one nerve to accomplish the effect! Why are the internal rectus, the inferior oblique, and the inferior rectus supplied from one nerve source, to the exclusion of the external rectus, and the supe-

rior oblique muscles? Furthermore, why is the iris supplied with nerve power from the third nerve, and not also from the fourth nerve or the sixth nerve?"

As was stated in the introductory lecture of this course, when touching upon the distribution of nerves in general, Nature often indicates, by the distribution of the nerves, some valuable hints as to the physiology of the parts supplied by each nerve filament; and such questions, as are presupposed above, will, if constantly asked by the student of anatomy, often enable him, by close study, to gain not only information of a most practical kind, but it will also greatly assist him to retain in his memory what would otherwise escape, and render this line of study a source of unceasing pleasure and interest.

It is evident, when a glance at the distribution of the motor oculi nerve is taken, that it is essentially the *nerve of accommodation of vision* for objects of variable distances from the retina. By its control over the internal muscles of the orbit, the eyes can be moved in unison in their endeavor to focus objects simultaneously upon each retina, and thus to gain a perception of the *solidity* of objects, which can not be afforded by one eye alone. It is a fact, which perhaps the reader has never thought of, that the two external recti muscles, or the two superior oblique muscles, are seldom called into simultaneous action, since they both tend to cause the eye to roll outward, and thus oppose the natural movement of the two eyes, one of which usually moves inward while the other moves outward, in order to favor the perception of the same objects by the retina of each eye. For this reason alone, it would be impossible that these two muscles of each orbit should be supplied from the same nerve as the other muscles, since they could not possibly act in harmony with each other. Again, the superior oblique and the external rectus muscles are seldom called into simultaneous action except in oblique movements of the eye, and their actions are so dissimilar that they have often to act both with and without the aid of the other; hence two nerves (the



fourth and sixth) are furnished so that each muscle can have its own source of nerve supply

The distribution of the third nerve to the iris affords a still more beautiful example of the constant efforts of Nature to bring all parts into a harmony with each other, and by the simplest means at her control. It has been mentioned, in connection with the optic nerve, that the *pupil contracts* as the eye is drawn inward, and also in attempts to focus near objects upon the retina. Now, the third nerve is the nerve by which not only is the eye drawn inward, but it is also the nerve by which the ciliary muscle of the eye is enabled to affect the *convexity* of the *crystalline lens* of the eye, and thus to act as an adjuster of the focal distance of objects whose images fall upon the retina. How important it is, therefore, that the pupil which is so essential to the proper performance of vision, since it controls the quantity of light admitted to the retina, should be placed under the same nervous control as the muscles of accommodation of vision !

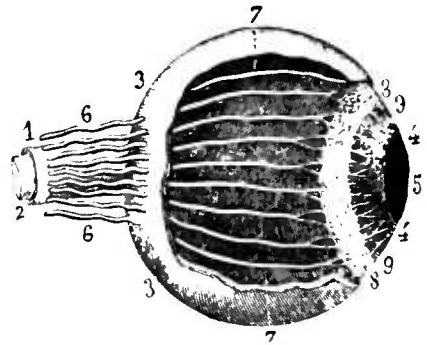

FIG. 47.—*Ciliary nerves, course and termination.* (After Sappey.)

- 1, optic nerve, covered by its external or ligamentous envelope;
- 2, optic nerve, covered only by its proper envelope (neurilemma);
- 3, 3, sclerotic, or fibrous envelope of the eyeball;
- 4, 4, iris;
- 5, pupil;
- 6, 6, ciliary nerves penetrating the sclerotic;
- 7, 7, nerves passing between sclerotic and choroid;
- 8, 8, plexus resulting from their anastomoses;
- 9, 9, ramifications extending from this plexus into the iris.

#### MECHANISM OF THE DILATATION OF THE PUPIL.

The pupil is made to dilate by means of muscular fibers, which radiate from the margin of the pupil toward the circumference of the iris. It is probable that these fibers are under the control of the *sympathetic system* of nerves. If so, it must be observed that the sympathetic nerves have an effect upon the iris directly opposite to that which it exercises upon the blood-vessels, since, when it is stimu-

<sup>1</sup> Experiments of Julius Budge, 1851, and Augustus Waller, "Gazette Medicale de Paris." Discovered by Petit, 1712.

lated, the pupils are dilated, while the blood-vessels are contracted.

Mosso<sup>1</sup> has endeavored to show a relation between the *turgescence* of the vessels of the iris and the extent of dilatation of the pupil which exists at the same time, and thus to avoid

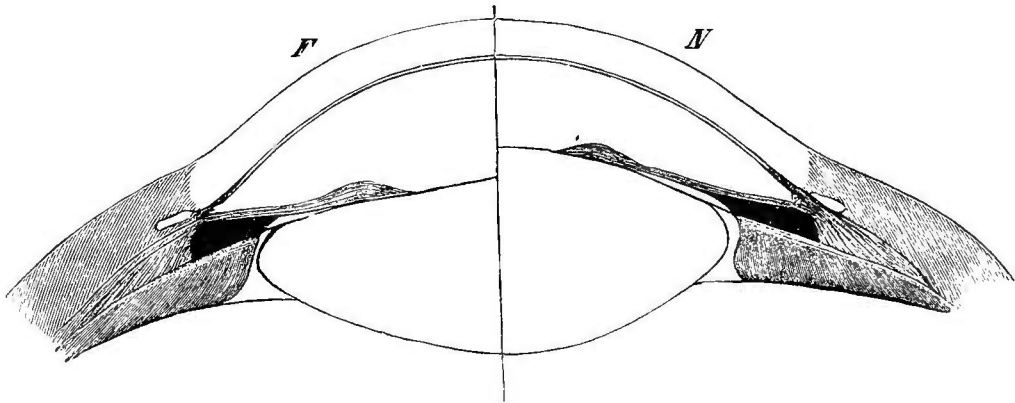

FIG. 48.—Section of the lens, etc., showing the mechanism of accommodation. (Fick.)

The left side of the figure (*F*) shows the lens adapted to vision at infinite distances; the right side of the figure (*N*) shows the lens adapted to the vision of near objects, the ciliary muscle being contracted and the suspensory ligament of the lens consequently relaxed.

the apparent inconsistency in the effect of the sympathetic system upon the same type of muscular structure.

Oehl<sup>2</sup> and others claim that the sympathetic fibers, which act in antagonism to those of the third nerve upon the iris, are not derived from the ophthalmic ganglion, but accompany the ophthalmic branch of the fifth cranial nerve, and enter the eye with the long ciliary nerves; and that, when these sympathetic filaments are divided, stimulation of the main sympathetic cords no longer causes dilatation of the pupil. He thus ascribes to the *fifth cranial nerve* the power of dilating the pupil, and regards the Gasserian ganglion as the source from which this power is derived from the sympathetic system.

The experiments of Oehl were made upon dogs and rabbits, and have been confirmed by Rosenthal, Hensen, Volckers, and Velpeau. The effect of these fibers of the fifth nerve is thought by these observers to be dependent upon a vasa-motorial influence upon the blood supply of the iris.

<sup>1</sup> C. F. Mosso, Turin, 1875.

<sup>2</sup> Henle und Meissner's "Bericht," 1862.

Slight oscillations of the pupil may be observed to occur synchronously with the action of the heart, and others, also, with the respiratory movements. These oscillations have been by some considered as an evidence that the movements of the pupil were the result of alterations in its vascularity, the iris contracting when its vessels are filled, and dilating when its vessels are empty; but the physiological fact that the movements of contraction and dilatation of the pupil are noticed in the bloodless eye seems to point to some other agency than simply an alteration in the blood supply.<sup>1</sup>

#### MOTIONS OF THE EYEBALL.

Since the third nerve is distributed to all of the muscles of the eyeball but two, the motions of the eye are largely controlled by it; while *accommodation of vision* is also produced by its distribution to the ciliary muscle. Some practical facts may be here noted respecting the movements of the eyeball, which have not only a general interest, but a diagnostic value.

The eye is virtually a ball placed in a socket, the orbit

<sup>1</sup> "The impairment of iritic reflex action ('pupillary reflex') was first intelligently studied in 1869, by Dr. Argyll Robertson, of Edinburgh. His observations have since been abundantly verified by numerous observers, and an exhaustive paper on the subject has been published by Professor W. Erb, of Leipsic, in the *Archives of Medicine*, October, 1880. Robertson, and others after him, noticed that the pupils of tabetic patients did not dilate in the shadow and contract in the light, as do normal pupils, and they further observed that during the effort of accommodation there occurred a normal pupillary contraction. In other words, the reflex iris movements were abolished, while its associated quasi-voluntary movements were preserved. These phenomena may be observed in almost all patients suffering from posterior spinal sclerosis, and I am in the habit of calling the attention of students to the symptom. In two of the patients now under my care this condition is not present, but there have been cases of abnormal sclerosis in which all the symptoms appeared in a most irregular manner." (E. C. Seguin, "Med. Record," 1881.)

"The pupils in a suspected case of posterior-spinal sclerosis are to be tested in the following manner: the patient is placed, seated or standing, facing a brightly illuminated window, and told to keep his look fixed on some distant object, such as a house or tree. By alternately closing and opening the lids, or, better, by shading the eyes with one's hand momentarily, it is easy to see if the pupils change diameter. It is of the utmost importance that the patient's intelligent assistance be secured, in order that his gaze shall remain adjusted for distance. In a given case the absence of reaction to light having been noted, we next hold up one finger or a small object within a foot of the patient's face, and bid him look at it. At once the pupils contract, and do so in proportion to the accommodative effort and the coincident convergence. When the patient looks at the distant object, and relatively or absolutely relaxes his accommodation, the pupils dilate again."

and the globe forming a ball-and-socket joint. In its socket joint, the eye is capable of a variety of movements ; but it can not, by any voluntary effort, be moved out of its socket. By disease, however, the position of the eyeball within the cavity

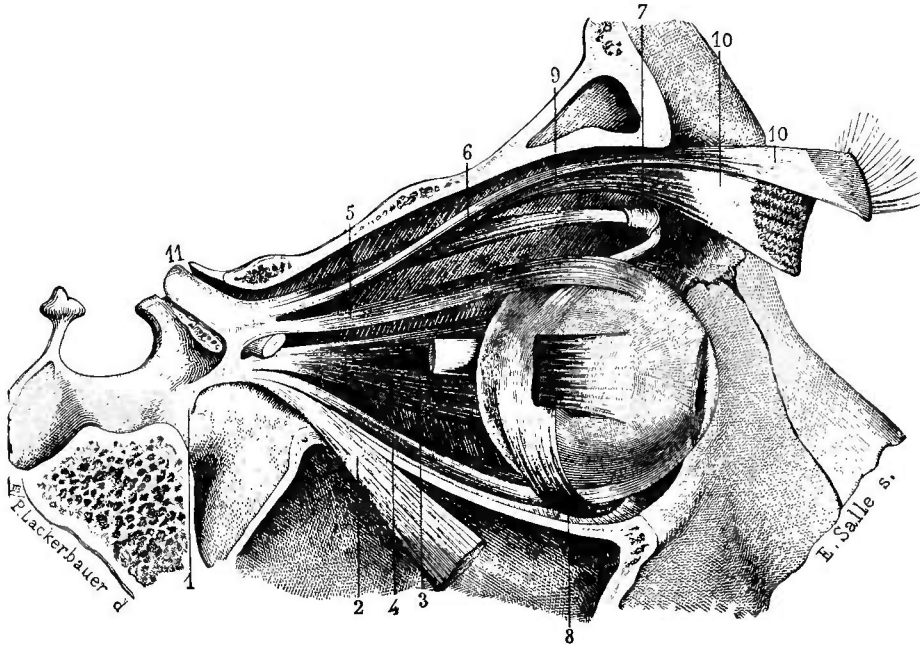

FIG. 49.—*Muscles of the eyeball.* (Sappey.)

1, attachment of the tendon connected with the inferior rectus, internal rectus, and external rectus ; 2, external rectus, divided and turned downward to expose the inferior rectus ; 3, internal rectus ; 4, inferior rectus ; 5, superior rectus ; 6, superior oblique ; 7, pulley and reflected portion of the superior oblique ; 8, inferior oblique ; 9, levator palpebrae superioris ; 10, 10, middle portion of the levator palpebrae superioris ; 11, optic nerve.

of the orbit may be materially altered. By pressure on the nerves distributed to its muscles, paralysis of those individual muscles may result which are supplied by the affected nerve, and the eye may thus be deflected from its normal position by the other muscles, whose motor power is unimpaired. The anatomical fact, that the muscles which move the eyeball derive their motor power from three sources, viz. : the third, fourth, and sixth cranial nerves, may often be made a means of determining the situation of abnormal conditions within the orbit or cranial cavity, by a thorough familiarity with the points of origin of each of these nerves, and the relations which each bears to the surrounding parts throughout the whole length of its course.

It has been shown by Donders that, though we can move the eye in almost every possible variety of inclination, we can not, by a *voluntary* effort, rotate the eyeball around its longitudinal visual axis. The arrangement of the muscles of the eyeball would seem to permit of such a movement, but we can not by any direct effort of will bring it about by itself, although we can occasionally produce it unconsciously when we endeavor to move the eyeballs in certain special directions.

During movements of the head, the eyes, if directed toward an object, may be kept stationary upon that object, in spite of such movements of the head,<sup>1</sup> very much as the needle of the ship's compass remains stationary when the ship is turned. By this wonderful coördination of movement *steadiness of vision* is insured, which would be otherwise impossible.<sup>2</sup>

A TABLE SHOWING THE ACTION OF THE OCULAR MUSCLES.

Straight movements.	{	To <i>elevate</i> the eye.. . . .	{ Rectus superior.
			{ Obliquus inferior.
		To <i>depress</i> the eye. . . . .	{ Rectus inferior.
			{ Obliquus superior.
Oblique movements.	{	To <i>adduct</i> toward the nasal side. . . . .	Rectus internus.
		To <i>adduct</i> toward the malar side. . . . .	Rectus externus.
		To <i>elevate</i> and <i>adduct</i> the eye.. . . .	{ Rectus superior.
			{ Rectus internus.
			{ Obliquus inferior.
		To <i>depress</i> and <i>adduct</i> the eye.. . . .	{ Rectus inferior.
			{ Rectus internus.
			{ Obliquus superior.
To <i>elevate</i> and <i>abduct</i> the eye. . . . .	{ Rectus superior.		
	{ Rectus externus.		
	{ Obliquus inferior.		
To <i>depress</i> and <i>abduct</i> the eye. . . . .	{ Rectus inferior.		
	{ Rectus externus.		
	{ Obliquus superior.		

In the accompanying table,<sup>3</sup> in which the various motions of the eye are enumerated, and the combinations of muscles necessary to produce each of these individual motions are shown, it will be perceived that in the *straight* deflections of

<sup>1</sup> An effect due chiefly to the action of the oblique muscles of the eye.

<sup>2</sup> Mich. Foster, "Text-Book of Physiology."

<sup>3</sup> After Mich. Foster, *op. cit.*

the globe of the eye never more than two muscles are required to produce them, and often only one; while, in the *oblique* deflections of the globe, three muscles are always compelled to work in unison. It may furthermore be stated that, to counterbalance the action of either of the oblique muscles of the eye, two muscles are always required. Suppose, for example, that the superior oblique muscle of the orbit was paralyzed from pressure upon the fourth nerve, the eye would then be drawn downward and outward only by the combined action of the external and inferior recti muscles, although that is the direct line of action of the muscle paralyzed; while, if that muscle should contract, and thus displace the eye downward and outward, the antagonistic muscles would be the superior and internal recti muscles, since the former would tend to draw the eye upward and inward, while the latter would also assist in drawing the eye inward.

The ability to move either of the eyes independently of the other is possessed by very few individuals, although, in rare cases, such a power is present. The movements of the eye have been so arranged by Nature that the objects seen shall affect the corresponding portions of each of the two retinae, in order to insure single vision; and, for that reason, the two eyes will be perceived to move exactly alike, each passing simultaneously to the left or to the right, upward or downward.

It is evident, therefore, when we throw into action the rectus internus of one eye, that we use the rectus externus of the opposite eye, and vice versa, in case the object to be focused upon the retinae lies away from the median line of the head; but, if it lies in the direct line of vision, but so close to the face as to require a muscular effort to focus it upon the retinae, then the two internal recti muscles are called into simultaneous action. Finally, in case the object to be perceived lies at a distance from the eyes, it becomes necessary for the eyes to be brought into nearly a *condition of parallelism*, to accomplish which the two external recti muscles are called into simultaneous action.

Such a complex coördination of movement as the various positions of the eyes demand would seem to indicate that a special arrangement had been made within the component parts of the brain to provide for its control, and thus insure

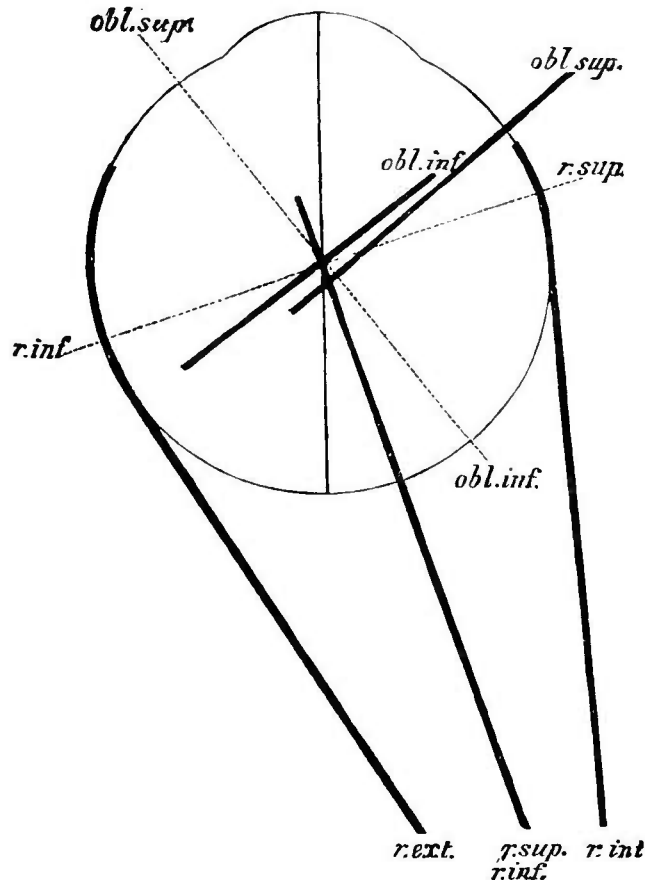

FIG. 50.—Diagram showing the arcs of rotation of the eyeball. (After Fick.)

The black lines indicate the direction of the power applied by each of the six ocular muscles. The dotted lines indicate the axis of rotation of the eyeball. The axis of rotation for the rectus externus and rectus internus muscles, being perpendicular to the page, can not be shown in the diagram.

that harmony which is absolutely required. The experiments of Adamük<sup>1</sup> tend to designate the tubercula quadrigemina as provided with distinct centers, which control certain movements of the eyes. Thus, he finds in *the nates* (the upper portion of the *tubercula quadrigemina*) a common center<sup>2</sup> for both eyes, stimulation of the right side producing movements of both eyes to the left, of the left side, movements to the right; while stimulation of the middle line, behind, causes a

<sup>1</sup> Quoted by Flint, Foster, and others.

<sup>2</sup> For details concerning this center, see page 58 of this volume.

downward movement of both eyes, with a convergence of the axes, and, if made in front, an upward movement with a return to parallelism, both of which effects are accompanied by the movements of the pupil naturally associated with them.

The third nerve has a decided importance in affording us one means of determining the distance of objects from the retinae which perceive them, viz., the *muscular sense*. It has been previously stated that, in order to perceive near objects, the *internal recti* and the *ciliary* muscles of either eye are called into simultaneous action, and we soon learn to unconsciously estimate the amount of muscular power required to properly adjust the eye for distinct vision, and thus to use the third nerve, as well as the optic nerve, as a guide to the accurate determination of distance.

ALTERATION OF THE POSITION OF THE HEAD FROM PARALYSIS OF  
THE OCULAR MUSCLES.

It is a fact well known among oculists, and one which often helps them materially in diagnosis, that the defects of vision, occasioned by impairment in the power of some of the muscles, which control the eyeball, cause the patients unconsciously to assume a *position of the head* which tends to assist them in the use of the affected eye. So diagnostic are some of the attitudes assumed by this class of afflicted people, that the condition which exists may be told at a glance, as the patient enters a room, by one thoroughly familiar with the diseases of this important organ. The explanation of this tendency, on the part of this class of patients, lies in the fact that any loss of power in the ocular muscles immediately shows itself in the perception of every object, as it were, doubled; and it is to overcome these *double images* that patients almost instantaneously discover their ability to get rid of the annoyance by some special attitude, which, of course, depends upon the muscle which is weakened or paralyzed.

It will be necessary, in order to make you clearly understand the mechanism of this peculiarity, that the separate



action of the six muscles which directly act upon the globe of the eye be considered.

The action of each of the ocular muscles may be given, then, as follows, with the proviso that many of the motions of the eye are not the result of the contraction of any single muscle, but often of a number acting either in unison or successively.

The *superior oblique* muscle turns the eye downward and outward.

The *inferior oblique* muscle turns the eye upward and outward.

The *superior rectus* muscle turns the eye upward and inward.

The *inferior rectus* muscle turns the eye downward and inward.

The *internal rectus* muscle turns the eye directly inward.

The *external rectus* muscle turns the eye directly outward.

This statement as to the above muscles reveals nothing which would not be immediately suggested by the insertion of each, with the exception of the superior and inferior recti muscles, which, besides the action which their situation would naturally suggest, tend also to *draw the eyeball inward*, on account of the obliquity of the axis of the orbit and the same obliquity of the muscles, since they arise at the apex of the orbit. The action of the oblique muscles is, as any one familiar with their origin and insertion would naturally surmise, to control the oblique movements of the eyeball.

Now, as soon as any one of these six muscles becomes pressed upon and weakened by the presence of tumors, inflammatory exudation, syphilis, or other causes, the patient at once *perceives double images*, and, in order to get his eye into such a relative position with that of the healthy side as to enable them both to focus upon the same object in a natural manner, the patient soon learns to so move his head as to compel the two eyes to look in parallel directions.

A very simple rule can be suggested by which you may be enabled, not only to tell in what direction a patient would move

his head in case any special muscle be rendered weak or utterly useless, but also to diagnose the muscle affected, when you look at the patient, without any knowledge of his history. The rule may be thus stated: *In paresis of any of the ocular muscles, the head is so deflected from its normal position that the chin is carried in a direction corresponding to the action of the affected muscle.*

Thus, in paresis of the external rectus,<sup>1</sup> the chin would be carried outward toward the injured muscle; while, in paresis of the internal rectus muscle, the head would be turned away from the side on which the muscle fails to act. In case the superior oblique muscle is impaired, the chin would be carried downward and outward; while, in the case of the inferior oblique muscle, the chin would have to be moved upward and outward to benefit the vision of the patient. The superior and inferior recti muscles, when impaired by disease or other causes, would likewise create a deflection of the head in a line corresponding to that of their respective actions.

#### CLINICAL POINTS OF INTEREST PERTAINING TO THE THIRD NERVE.

Paresis of the external and internal recti muscles causes, in addition to the facts already described, another point of very great value in diagnosis, viz., an alteration in the *apparent size* of the objects seen from what they would be in health. The condition of vision, termed by oculists "*megalopsia*" or "*macropsia*," signifies paresis of the external rectus; while the opposite condition, called "*micropsia*," indicates loss of power in the internal rectus muscle.

In the former of these conditions, the objects seen by the patient seem to be greater in point of size than the intelligence of the patient assures him is the case; while, in the latter, objects seem smaller to the patient than they really are.

To explain to you just how these variations of vision are

<sup>1</sup> While this statement would be absolutely true in theory in all cases, we must acknowledge, as a clinical fact, that patients learn to *utterly disregard* the image in the affected eye, when the *internal* or *external rectus* is the seat of paresis, and to use the normal eye only for the purposes of vision, thus rendering this attitude of the head less diagnostic than when the oblique muscles are affected.

accomplished may require a more extended discussion of the physiological problems of vision than an anatomical discussion can properly deal with; but, to understand it, you must know that the apparent size of any object depends upon the ability of the person to properly and accurately *appreciate the angle* formed between rays of light coming from the object and entering the pupils of each eye, or, in other words, the distance at which the object is placed from the retina. Now, in the case of paresis of the external rectus muscle, the object is caused to appear nearer to the eye than it really is, and thus to be larger than normal vision would cause it to seem, since the angle of the axes of vision is greater; while, in case of the paralysis of the internal oblique, the object is apparently much farther removed from the eye than it really is, and thus the intelligence construes it as of smaller size than it would if the visual perceptions were normal.

There is only one other condition of the eye where the size of objects perceived by the retina is either increased or markedly diminished, if the actual size be taken as a standard of measurement, and this condition is one of inflammation of the choroid coat of the eye. It is a well-recognized fact that, in the *effusive form* of choroiditis, objects are perceived as much smaller than they really are, while in *cicatricial* choroiditis the size of the object is magnified.

These phenomena can not be explained as the result of a change in the angle of the axis of vision, since nothing exists to disturb the perception of distance; but it is attributed to a separation, in the one case, and to an aggregation in the other, of the *cones* of the retina.

The eye, by constant use, has become enabled to partly estimate the size of objects by the *number of cones* in the retina which are covered by the image of the object. Thus, when, from causes such as have been mentioned above, the elements of the retina are either huddled more closely together by a cicatrix of the choroid coat of the eye, or disseminated over a larger space than they normally occupy by an effusion of the choroid coat, the *number of cones* covered by

the image thrown upon the retina is either increased, thus apparently magnifying the size of the object, or the number of cones affected is decreased, and thus the size of the object seen is apparently diminished.

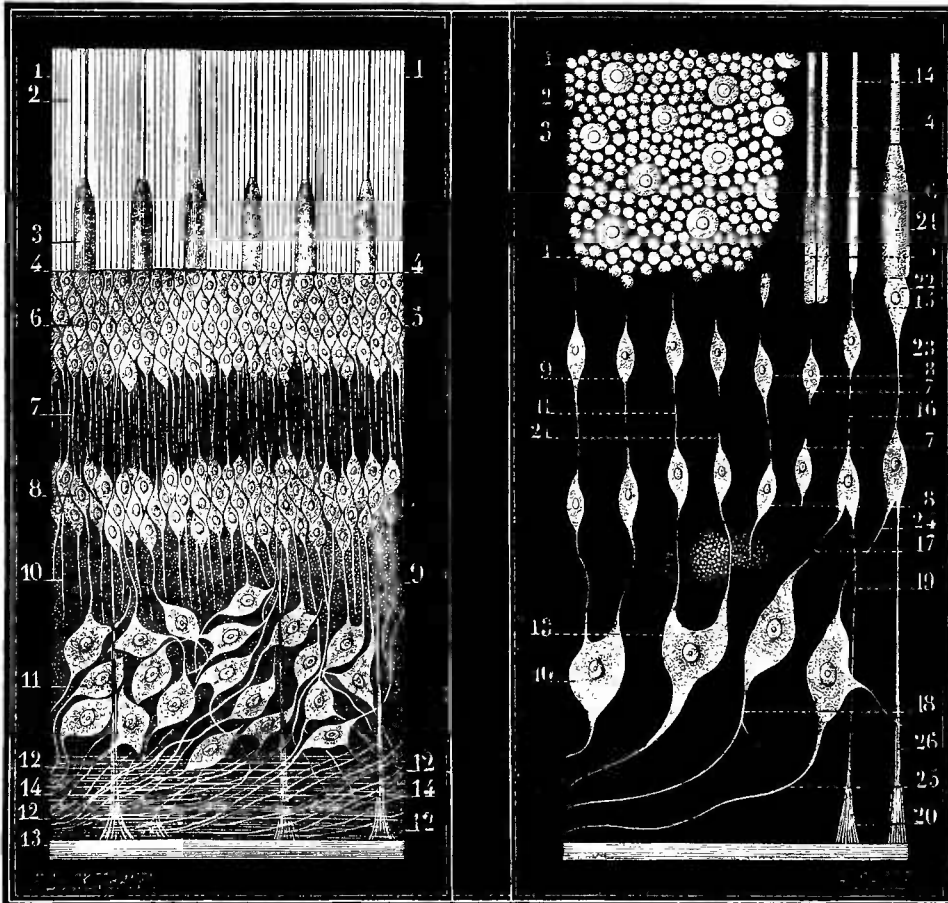

FIG. 51.—A. *Vertical section of the retina.* B. *Connection of the rods and cones of the retina with the nervous elements.*  
(H. Müller.) (Sappey.)

- A. 1, 1, layer of rods and cones; 2, rods; 3, cones; 4, 4, 5, 6, external granule layer; 7, inter-granule layer (cone-fiber plexus); 8, internal granule layer; 9, 10, finely granular gray layer; 11, layer of nerve cells; 12, 12, 12, 12, 14, 14, fibers of the optic nerve; 13, membrana limitans.
- B. 1, 1, 2, 3, rods and cones, front view; 4, 5, 6, rods, side view; 7, 7, 8, 8, cells of the external and internal granule layers; 9, cell, connected by a filament with subjacent cells; 10, 13, nerve cells, connected with cells of the granule layers; 11, 21, filaments connecting cells of the external and internal granule layers (12 is not in the figure); 14, 15, 16, 17, 18, 19, 20, 22, 23, 24, 25, 26, a rod and a cone, connected with the cells of the granule layers, with the nerve cells, and with the nerve fibers.

In cases where complete blindness, even to the sensation of light, exists, as sometimes occurs in amaurosis,<sup>1</sup> the eyes

<sup>1</sup> For the causes of this condition, see page 127 of this volume.

remain fixed and immovable, gazing steadily forward, even when objects are made to pass before the vision; while in cases of partial blindness, which prevent the perception of outline, but still allow of the perception of passing objects between the light and the retinae, by the shadow which they throw, the eye involuntarily moves in a direction which corresponds to that of the moving object.

Cases in which the third nerve has been impaired by pressure or disease, or totally destroyed by section, are characterized by a falling of the upper eyelid over the pupil,<sup>1</sup> and an inability to raise it, owing to the inaction of its levator muscle, so that the eye appears constantly half shut. This condition is known by the name of "*ptosis*." The movements of the eyeball are also nearly suspended, and permanent *external strabismus* takes place, owing to the paralysis of the internal rectus muscle, while the external rectus, animated by a different nerve, preserves its activity. From paralysis of the fibers distributed to the iris, a *dilatation of the pupil* is also produced, and *accommodation* of the injured eye for near objects is no longer performed.

While the upper eyelid is partially raised by the levator palpebræ muscle, which is supplied by the third nerve, it is also raised by means of muscular fibers, which are governed by the cervical sympathetic. A similar set of fibers exists in the lower eyelid, and is governed by the same nerves; and it is probably through the influence of the *sympathetic system* that the eye is opened. In the act of winking, where the shutting of the eye is usually affected more rapidly than the opening, a contrast is afforded between the action of the cranial nerves and those of the sympathetic, since closing of the eye is performed by the facial nerve.<sup>2</sup>

External strabismus may often occur without the condition of "*ptosis*" being present, the filament to the levator palpebræ muscle not being affected.

When all the muscles supplied by the third nerve are

<sup>1</sup> So marked is this deformity that the upper lid frequently almost touches the lower lid.

<sup>2</sup> Mich. Foster, *op. cit.*

paralyzed, the globe of the eye is slightly protruded, from relaxation of most of its muscles.

In *strabismus*, or *squint*, an optical defect<sup>1</sup> is usually present. So large is the percentage of optical error in those cases where the eyes turn inward toward the nose, that this condition seldom exists without an accompanying hyperopia or far-sightedness, due to a diminution of the antero-posterior axis of the eye.; while in external squint, where the eye looks away from the nose, the opposite condition of myopia, or near-sightedness, is often present, but perhaps not in as large a percentage of cases as in the opposite deflection of the eye. For this reason, operations are often of little benefit when performed for the relief of strabismus, unless the error in vision is accurately determined and corrected by the appropriate lenses.

#### DISEASES OF THE OCULAR MUSCLES AND THEIR CAUSES.

The muscles of the orbit may present the conditions of spasm, contracture, motor irritation, or paralysis.

The condition of "*nystagmus*" is characterized by clonic spasm of the external ocular muscles, and by peculiar oscillations or involuntary movements of the organ. It is always a bilateral affection, and its starting-point, according to the experiments of Adamuk and Ferrier,<sup>2</sup> seems to be situated within

<sup>1</sup> See Haynes Walton, Stellwag, and others. In speaking of this optical defect, dependent upon simple hyperopia, Dr. Loring says, in an article previously quoted in this volume: "I have known boys of eight or ten years of age to beg their parents to let them undergo the pain of an operation to rid themselves of a deformity which subjects them so often to the unfeeling remarks of their elders, usually friends of the family, as well as the unepithetious but expressive titles bestowed upon them by their own contemporaries, of goggle-eye and cock-eye. Nor does this end with childhood. The deformity is a disadvantage to him through life. It pursues him in his business and in his profession. Cheated of feature by dissembling nature, he is often thought to be dissembling himself, when nothing is further from his thoughts. How often do we hear people say of another, whom we know to be perfectly upright and trustworthy, that they do not like him because he never looks them squarely in the face! And it is a little curious that precisely here it is that the lesser degrees of the trouble produce the most effect. That peculiar expression which people complain so much of is generally due to a deviation in the axes of the eyes—a slight convergence, which is never very conspicuous, and at times only to be detected by a trained eye, but which, nevertheless, produces in all a very disagreeable impression, although not marked enough to betray its cause.

<sup>2</sup> See page 58 of this volume.

the anterior tubercula quadrigemina. It may be produced by causes affecting either the central nerve ganglia, the peripheral nerves, the refracting media of the eye, or the retina. We thus find it existing in connection with meningitis, hydrocephalus, etc., in uterine diseases, worms, dentition, caries of the teeth, etc., and in some of the diseases of the eye or optic nerve.

Spasm of the *fibers of the iris* is observed, in rare cases, to exist in connection with some irritative condition of the cerebro-spinal system, which has involved the *cilio-spinal center* of the spinal cord.<sup>1</sup>

By *contracture* of a muscle is meant a permanent shortening, in contrast to its temporary shortening when under the ordinary influence of the motor stimulus. It occurs, in the ocular group of muscles, as the result of the direct irritation following some pathological process, at a seat more or less distant from the orbit; or as the effect of prolonged paralysis of some of the antagonistic muscles.

In those cerebral and spinal conditions in which convulsive attacks are produced, and in attacks of hysteria, the evidences of well-marked *motor irritation* of the ocular muscles are often observed.

*Paralysis* of the ocular group of muscles may vary in degree, thus constituting either paresis or true paralysis; also in extent, thus affecting all the muscles supplied by the third nerve, and often the fourth and sixth nerves as well, or, again, only separate muscles; and finally in duration and its susceptibility to treatment. This symptom may be either an initial symptom, or a complication of some central disease, or the result of peripheral causes.

Paralysis of the muscles supplied by the third nerve is most frequently produced by the following causes: Circumscribed meningeal processes at the base of the skull; tumors, softening, and hæmorrhage of the cerebral peduncles; softening and hæmorrhage of the cerebral ganglia; syphi-

<sup>1</sup> For details as to the situation and function of this center, the reader is referred to subsequent pages of this volume.

lis (affecting the cranial or orbital cavity); orbital tumors; diphtheria; and, finally, aneurisms of the carotid (as reported by Lebert<sup>1</sup>). In the *development of ataxia*, the third nerve may become paralyzed simultaneously with other nerves of the cranium, or, possibly, without other nerves being affected, and the same condition may follow the prolonged use of conium or gelsemium.

When the paralysis of the third nerve is produced by intracranial lesions, the paralysis is liable to be bilateral or to tend toward a symmetrical development as the disease progresses; while the fourth and sixth nerves are often subsequently affected. There are also other symptoms, of great value in deciding upon the existence of intra-cerebral disease, which may be present, such as the coexistence of cephalalgia, vertigo, symptoms of neuro-retinitis, disturbances of speech and of the intellectual faculties, convulsive movements of a local or general type, a sense of weight in the limbs, or, possibly, the presence of paresis or paralysis of the muscles of the extremities.

“A very large proportion of tabetic patients tell of past or present diplopia, and, in a certain number of cases, the ocular paralysis precedes the pains and ataxia by several years. So true is this statement, that it has become an established practice with neurologists and ophthalmologists to suspect posterior spinal sclerosis in adults who present themselves with strabismus, diplopia, or ptosis. In such a case we should carefully question the patient about the occurrence of fulgurating pains, and test the pupillary and tendinous reflexes. I need hardly add that another obligatory line of inquiry in such cases is with reference to symptoms of syphilis.”<sup>2</sup>

The same remarks apply to atrophy of the optic nerve, which is occasionally an early symptom.

It is not infrequent for *lesions of the spinal cord* to produce paralysis of the ocular muscles. The presence of such an exciting cause may be surmised by the coexistence of vague neuralgias in the branches of the cervical or brachial plexuses,

<sup>1</sup> Quoted by Rosenthal.

<sup>2</sup> E. C. Seguin, “Med. Record,” 1881.



or in the sciatic nerves; of abnormal sensations in the back, knees, and soles of the feet; seminal emissions, frequent or prolonged erections, or diminished sexual power; extreme sensitiveness to moisture of the atmosphere or winds; a tendency to fatigue, often present after a night's repose; and an increase in the galvano-excitability of the main nerve trunks.

Paralysis of the ocular muscles may *accompany glosso-labio-pharyngeal paralysis* (Duchenne's disease<sup>1</sup>), if the center for the movements of the eye be affected at the same time as the centers of the muscles of speech and deglutition; in this case, the third and sixth nerves are frequently affected simultaneously. The same condition of the ocular muscles may also accompany *ataxic symptoms* of cerebral origin.

*Rheumatism* may produce ocular paralysis. This cause is to be suspected when no symptoms exist which seem to point to local trouble in the orbit or brain. It is found to affect the motor oculi and the abducens nerves more frequently than the patheticus.

*Diplopia* and *strabismus* are often the first symptoms of cerebral diseases or ataxia, since they may appear before the other parts of the muscular system are affected. If they show, at times, a tendency toward spontaneous retrogression, and again return with the simultaneous occurrence of neuralgic pain, the development of a cerebral lesion is rendered still more probable.

#### THE FOURTH (TROCHLEAR OR PATHETIC) NERVE.

The apparent origin of this nerve is from the *superior peduncle of the cerebellum*, and it then winds around it, passing close to the posterior border of the pons Varolii. The deep origin of the fibers may be traced to four different situations, as follows: 1, some fibers to the *substance of the*

<sup>1</sup> The symptoms of this condition will be found mentioned in more detail in connection with the hypo-glossal nerve.

*peduncle*; 2, other fibers to the *valve of Vieussens*, where they are lost, with the exception of a few, which can be traced to the *frenulum*; 3, a few fibers to the *tubercula quadrigena*; 4, a large bundle, which pass inward toward the median line and then *decussate* with corresponding filaments of the opposite side.

This decussation of the fibers of the nerve is for the same physiological reason, as was mentioned in connection with the

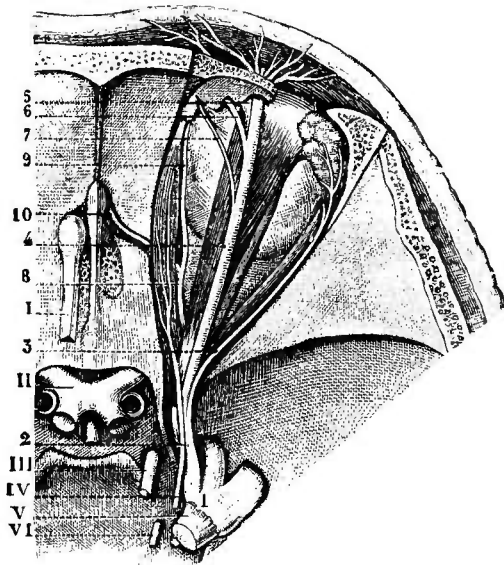

FIG. 52.—*Distribution of the pathetic.*  
(Hirschfeld.)

I, olfactory nerve; II, optic nerves; III, motor oculi communis; IV, *pathetic*, by the side of the ophthalmic branch of the fifth, and passing to the superior oblique muscle; VI, motor oculi externus; 1, ganglion of Gasser; 2, 3, 4, 5, 6, 7, 8, 9, 10, ophthalmic division of the fifth nerve, with its branches.

self simply into the mode of action of the *superior oblique muscle*. This muscle arises just above the inner margin of the optic foramen, and passes forward along the upper wall of the orbit, at its inner angle, to a little cartilaginous ring, which serves as a *pulley* for its tendon. Its tendon becomes rounded just before it passes through this ring, where it makes a sharp curve, passes outward and slightly backward, and becomes spread out, to be attached to the globe, at the superior and external part of its posterior hemisphere. It is, therefore, the direct antagonist of the inferior oblique muscle.

preceding nerve, viz., to afford harmony of action between the two sides, when the eyes are compelled to remain fixed upon an object during movements of the head.

From the point of apparent origin, the nerve passes forward along the *outer wall* of the cavernous sinus, where it lies *below the third nerve* and *above the ophthalmic branch* of the fifth nerve, and escapes from the cavity of the cranium, through the highest part of the sphenoidal fissure, into the cavity of the orbit.

The question of the function of this nerve resolves it-

In its function, it is purely a *motor* nerve, but it receives a few recurrent fibers from the fifth nerve, which are sensory

When this nerve is paralyzed, the position of the eye shows no apparent change, except when the head is moved from side to side, in which case the *eye moves with the head*; the absence of the usual compensating movement of the eye, which accompanies all the movements of the head, being destroyed in consequence of the paralysis of the superior oblique muscle, which greatly assists in this act. The patient also sees a double image, whenever attempts are made to look straight forward, or at objects situated toward the paralyzed side; but the image becomes a single one when the head is turned toward the sound side to view any object; hence this abnormality of attitude of the head is usually present.<sup>1</sup>

#### THE TRIGEMINUS OR FIFTH NERVE.

This important nerve has its apparent origin within the cranium from the *lateral aspect* of the *pons Varolii*, although its deep fibers have been traced by Lockhart Clarke to two distinct nuclei, situated in the *floor* of the *fourth ventricle* near to the gray tubercle of Rolando.<sup>2</sup> It is a mixed nerve, having a distinct *motor* and *sensory root*; and thus possesses both *afferent* fibers, through which sensory impressions are transmitted to the brain, and *efferent* fibers, by which motor impulses are transmitted from the brain to the periphery of some branches of the nerve.

The intimate relations which the nerve bears with the points of origin of the sixth, seventh, eighth, ninth, tenth, eleventh, and twelfth cranial nerves in the *floor of the fourth ventricle* possibly explain many of those phenomena which are considered as reflex in character, and whose starting-point

<sup>1</sup> For other examples of this diagnostic guide in paralysis of ocular muscles, see previous pages upon the third cranial nerve.

<sup>2</sup> See pages which relate to the medulla oblongata.

seems to depend upon some irritation of the fifth nerve by means of various branches.

The two roots of this nerve pass forward, side by side, as far as the petrous portion of the temporal bone. At this point a marked enlargement, called the ganglion of Gasser, is developed upon the *sensory root*; and subsequently this root

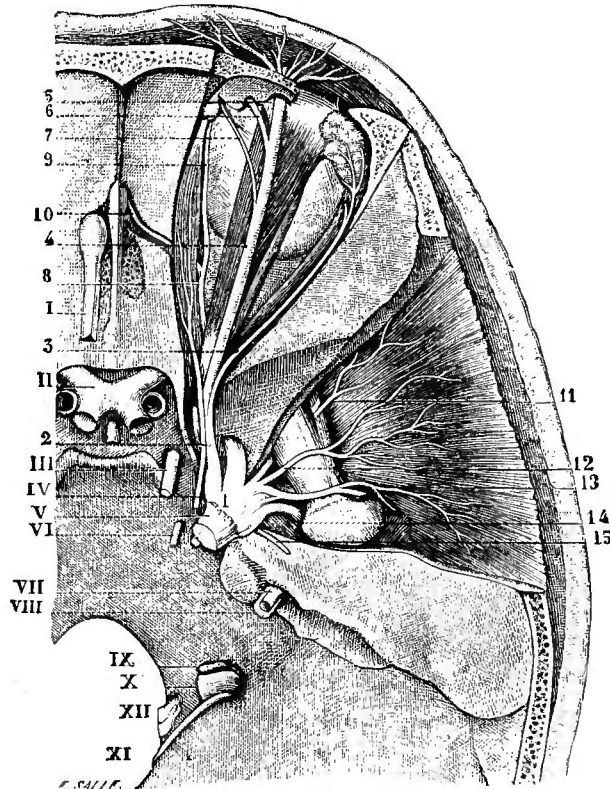

FIG. 53.—*Ophthalmic division of the fifth.* (Hirschfeld.)

1, ganglion of Gasser; 2, ophthalmic division of the fifth; 3, lacrimal branch; 4, frontal branch; 5, external frontal; 6, internal frontal; 7, supra-trochlear; 8, nasal branch; 9, external nasal; 10, internal nasal; 11, anterior deep temporal nerve; 12, middle deep temporal nerve; 13, posterior deep temporal nerve; 14, origin of the superficial temporal nerve; 15, great superficial petrous nerve. I to XII, roots of the cranial nerves.

divides into three large nervous trunks called, respectively, the ophthalmic, the superior maxillary, and the inferior maxillary nerves, which escape from the cavity of the cranium through different foramina.<sup>1</sup> The motor root accompanies the inferior maxillary nerve until it has escaped from the cranium, when it unites with it.

<sup>1</sup> The sphenoidal fissure, foramen rotundum, and foramen ovale respectively afford a passage for these branches from the cranium.

TABLE OF THE DISTRIBUTION OF THE FIFTH CRANIAL NERVE.<sup>1</sup>

FIFTH CRANIAL (TRIGEMINUS).	a. OPHTHALMIC NERVE.	(1) LACHRYMAL branch.		
		(2) FRONTAL branch.	Supra-orbital nerve.	
			Supra-trochlear nerve.	
	(3) NASAL branch.	Ganglionic nerve (to ciliary ganglion).		
		Long ciliary nerves.		
	b. SUPERIOR MAXILLARY NERVE.	In the <i>spheno-maxillary fossa</i> .	Infra-trochlear nerves.	
			Internal set.	To septum of nose.
		In the <i>infra-orbital canal</i> .	External set.	To mucous membrane and integument of nose.
			On the <i>face</i> .	ORBITAL or TEMPORO-MALAR NERVE.
		From the <i>anterior trunk</i> .	SPHENO-PALATINE NERVES (to Meekel's ganglion).	
POSTERIOR DENTAL NERVE.			Superficial dental branches.	
ANTERIOR DENTAL NERVE.			Deep dental branches.	
PALPEBRAL branches.				
c. INFERIOR MAXILLARY NERVE.		From the <i>anterior trunk</i> .	NASAL branches.	
			LABIAL branches.	
	(1) MASSETERIC branch.			
	From the <i>posterior trunk</i> .	(2) DEEP TEMPORAL.	Anterior branch.	
		(3) BUCCAL branch.	Posterior branch.	
		(4) PTERYGOID.	Internal branch.	
	From the <i>posterior trunk</i> .	(1) AURICULO TEMPORAL NERVE.	External branch.	
		(2) GUSTATORY NERVE.	Auricular.	
		(3) INFERIOR DENTAL NERVE.	Temporal.	
			Mylo-hyoid.	
		Incisor.		
		Mental.		
		Dental.		

From anatomical points which have been mentioned, and also by the above table, the fact is shown that the ophthalmic and the superior maxillary nerves possess *no motor power*, while the inferior maxillary nerve is *both motor and sensory* in its function. It has been mentioned in previous pages, however, that a *vaso-motorial* influence is possessed by the ophthalmic nerve, and also a direct power of dilating the pupils; but these effects are unquestionably dependent upon filaments given to it by the sympathetic nerve.

The ultimate distribution of the three branches of the fifth nerve may possibly be made more clear by grouping together the efferent and afferent fibers, and thus separating the parts

<sup>1</sup> Copied from "Essentials of Anatomy" (Darling and Ranney), New York, 1889.

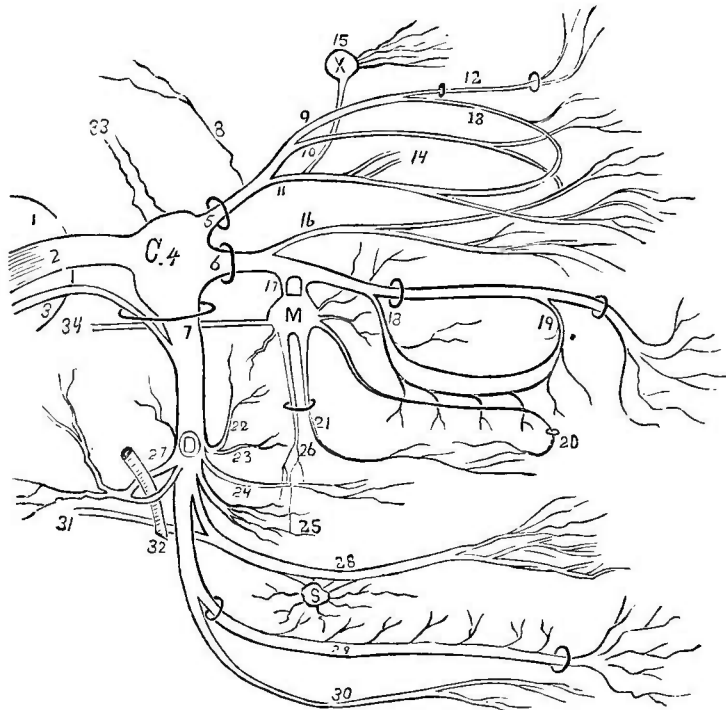

FIG. 54.—A diagram of the distribution of the fifth nerve.<sup>1</sup>

1, the *crus cerebri* ; 2, the *sensory root* of the nerve ; 3, the *motor root* of the nerve ; 4, the *Gasserian ganglion*, upon the sensory root only ; 5, the *ophthalmic nerve*, passing through the sphenoidal fissure ; 6, the *superior maxillary nerve*, passing through the foramen rotundum, to enter the spheno-maxillary fossa ; 7, the *inferior maxillary nerve*, passing through the foramen ovale in company with the motor root, which soon joins it ; 8, a filament sent backward from the ophthalmic nerve to the tentorium cerebelli ; 9, the *frontal nerve* ; 10, the *lacrimal nerve* ; 11, the *nasal nerve* ; 12, the *supra-orbital nerve*, passing through the foramen of the same name ; 13, the *supra-trochlear nerve* ; 14, the *long ciliary nerves* to the iris ; 15, the *lenticular, or ciliary ganglion* ; 16, the *temporo-malar nerve*, showing its division into the temporal branch and the malar branch ; 17, the *spheno-palatine nerves*, going to Meckel's ganglion ; 18, the *posterior dental nerves*, given off just before the superior maxillary nerve enters the infra-orbital canal, after passing through the spheno-maxillary fossa ; 19, the *anterior dental nerves*, given off in the antrum ; 20, the *naso-palatine nerve*, escaping at the anterior palatine foramen, after passing through the antrum ; 21, the *anterior palatine nerves*, after escaping from the posterior palatine foramen ; 22, the *deep temporal nerve* ; 23, the *masseteric branch* ; 24, the *buccal branch*, which often also supplies the external pterygoid muscle ; 25, the *pterygoid branch*, going chiefly to the internal pterygoid muscle ; 26, the *posterior palatine nerves*, after escaping from the posterior palatine foramen, going to the muscles of the soft palate ; 27, the *auriculo-temporal nerve*, splitting and thus embracing the middle meningeal artery ; 28, the *gustatory or lingual nerve*, distributed to the anterior two thirds of the tongue ; 29, the *inferior dental nerve*, passing through the inferior dental canal, beneath the teeth of the lower jaw ; 30, the *mylo-hyoid nerve*, a branch of the inferior dental nerve ; 31, the *chorda tympani nerve*, joining the gustatory nerve, and possibly bringing to it the *perception of taste* ; 32, the middle meningeal artery ; 33, the *fibers going to the carotid and cavernous plexuses of the sympathetic system* ; 34, the *Vidian nerve*, going from Meckel's ganglion to the Vidian canal. *Ganglia of the fifth nerve.*—L, The *lenticular ganglion*, sending fibers to iris and ciliary muscle ; c, the *Gasserian ganglion* ; o, the *otic ganglion*, lying on the *inferior maxillary nerve* below the foramen ovale ; s, the *submaxillary ganglion*, connected with the *gustatory and chorda tympani nerves* ; m, *Meckel's ganglion*, lying in the spheno-maxillary fossa.

<sup>1</sup> Modified from Flower.

which are supplied alone with sensation from those to which the motor root is eventually distributed.

The *efferent fibers* of the fifth pair give motor power to the muscles of mastication, viz., the temporal, masseter, and

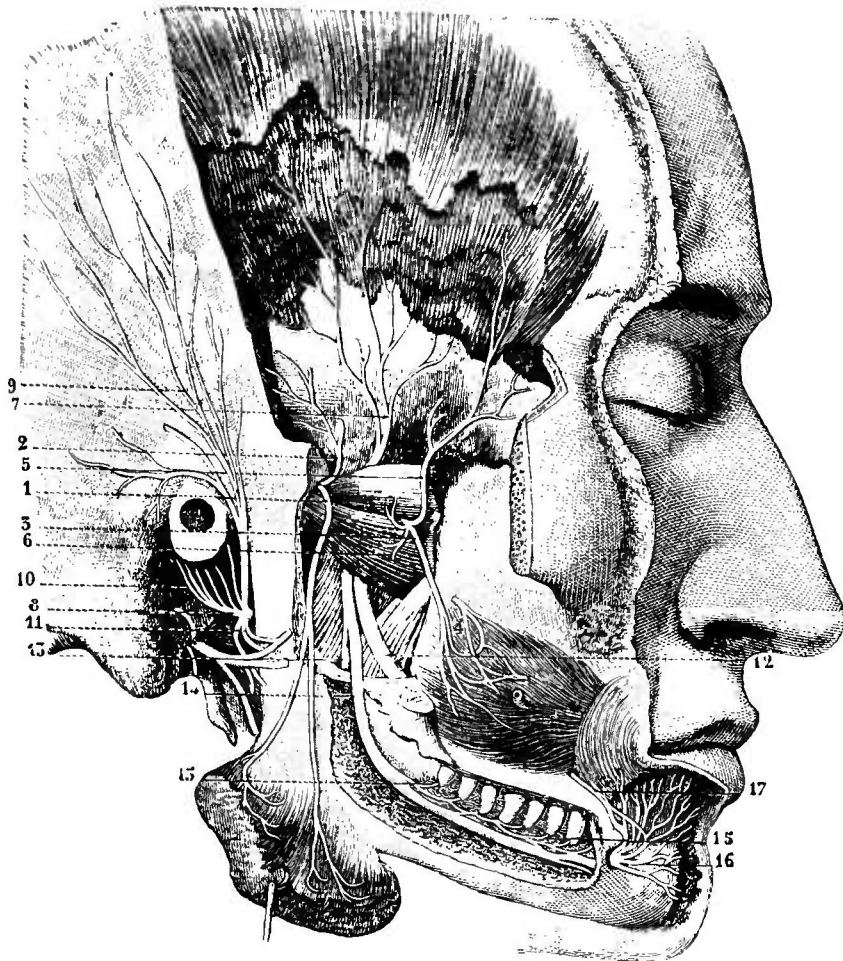

FIG. 55.—*Inferior maxillary division of the fifth.* (Hirschfeld.)

1, branch from the motor root to the masseter muscle; 2, filaments from this branch to the temporal muscle; 3, buccal branch; 5, 6, 7, branches to the muscles; 8, *auriculo-temporal nerve*; 9, *temporal branches*; 10, *auricular branches*; 11, *anastomosis with the facial nerve*; 12, *lingual branch*; 13, branch of the motor root to the mylo-hyoid muscle; 14, 15, 15, *inferior dental nerve, with its branches*; 16, *mental branch*; 17, *anastomosis of this branch with the facial nerve.*

pterygoids; also to the mylo-hyoid and anterior belly of the digastric, and to the tensor palati and tensor tympani. They thus control not only the physiological act of *mastication*, but also, to some extent, the acts of *deglutition* and *hearing*. These fibers furthermore afford a *vaso-motor* influence over various vessels in certain regions of the head and face. *Secretory fibers* to the lachrymal gland, and, according to some

authors, to the parotid and submaxillary glands, by means of fibers derived from the facial nerve (through the chorda tympani branch), are attributed to the trigeminus. By these fibers, the secretions necessary to the perfect performance of the parts supplied by the fifth nerve are also placed under its control, thus illustrating again that beautiful law of Nature in arranging the nerves in accordance with harmony of action. Beside the efferent fibers possessed by the fifth nerve, there exist in addition certain unnamed fibers which control the proper *nutrition* of the *eye, nose, and other portions of the face*. These latter fibers are not as yet fully ascertained so as to be described in detail, but their existence seems indi-

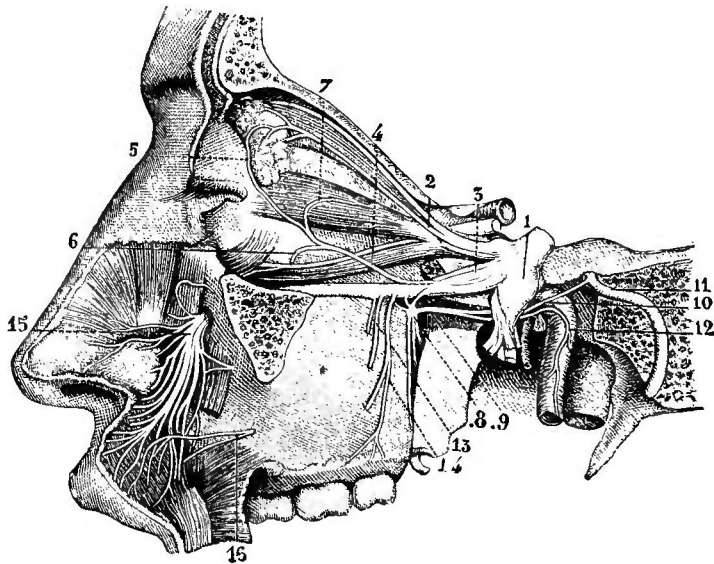

FIG. 56.—*Superior maxillary division of the fifth.* (Hirschfeld.)

1, ganglion of Gasser; 2, lacrimal branch of the ophthalmic division; 3, superior maxillary division of the fifth; 4, orbital branch; 5, lacrymo-palpebral filament; 6, malar branch; 7, temporal branch; 8, spheno-palatine ganglion; 9, Vidian nerve; 10, great superficial petrosal nerve; 11, facial nerve; 12, branch of the Vidian nerve; 13, anterior and two posterior dental branches; 14, branch to the mucous membrane of the alveolar processes; 15, terminal branches of the superior maxillary division; 16, branch of the facial.

cated by the fact that, after section of the fifth nerve, the cornea becomes cloudy; the whole eye becomes inflamed, only to subsequently disorganize; the mucous membrane of the nose is similarly destroyed, and ulcers frequently make their appearance upon the mucous membrane of the lips and gums. Snellen, however, considers these changes as the ef-



fects of the *mechanical irritation of dirt*, which the mucous membranes, no longer possessing sensibility, are unable to perceive.

The *afferent fibers* of the fifth nerve afford general sensation to the entire skin of the head and face, except in the *occipital region* and the *back* and *lower part* of the ear,<sup>1</sup>

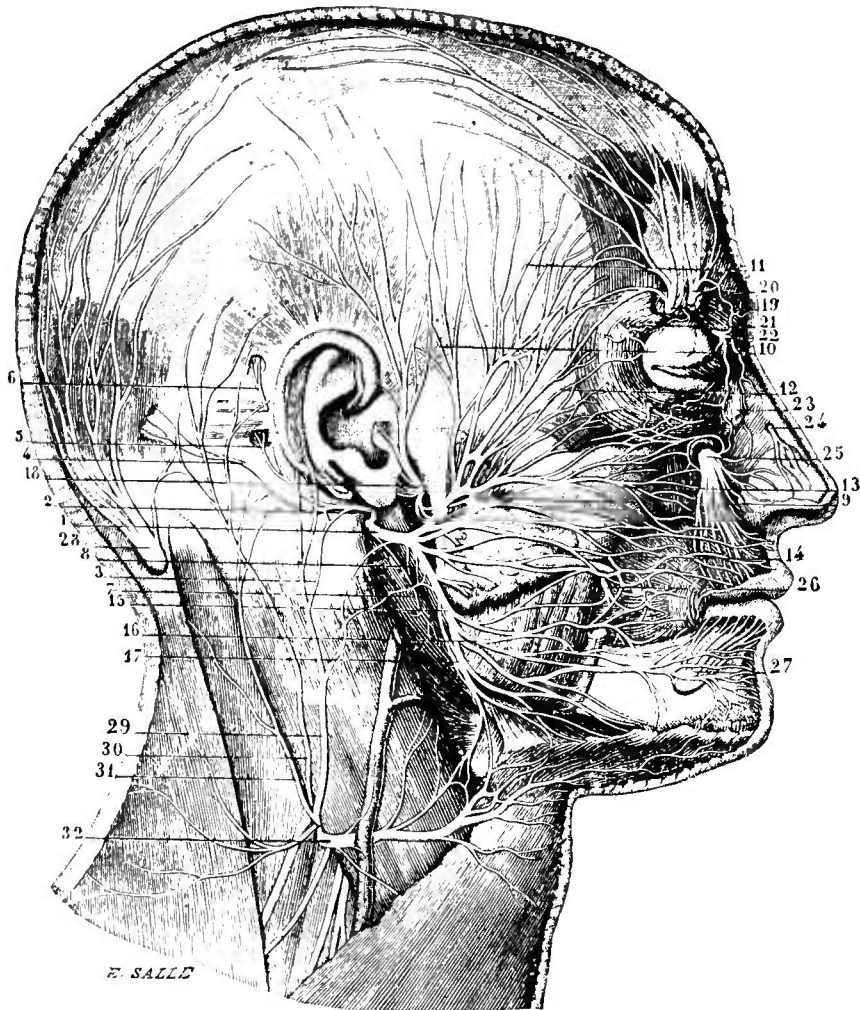

FIG. 57.—*Superficial branches of the facial and the fifth.* (Hirschfeld.)

- 1, trunk of the facial ; 2, posterior auricular nerve ; 3, branch which it receives from the cervical plexus ; 4, occipital branch ; 5, 6, branches to the muscles of the ear ; 7, digastric branches ; 8, branch to the stylo-hyoid muscle ; 9, superior terminal branch ; 10, temporal branches ; 11, frontal branches ; 12, branches to the orbicularis palpebrarum ; 13, nasal, or suborbital branches ; 14, buccal branches ; 15, inferior terminal branch ; 16, mental branches ; 17, cervical branches ; 18, superficial temporal nerve (branch of the fifth) ; 19, 20, frontal nerves (branches of the fifth) ; 21, 22, 23, 24, 25, 26, 27, branches of the fifth ; 28, 29, 30, 31, 32, branches of the cervical nerves.

and also to the mucous membranes of the mouth, with the exception of the posterior pillar of the fauces and the poste-

<sup>1</sup> Hilton.

rior third of the tongue, which derive their sensation by means of the glosso-pharyngeal nerves.

The accuracy of this statement, as regards the distribution to the integument of the ear, which is now accepted by most of the anatomical authors of the present day, was strangely attested to by facts brought under the notice of John Hilton,<sup>1</sup> who was thus enabled clinically to verify the exact distribution of the fifth nerve to the pinna and the auditory canal. It seems that an attempt was made by a criminal to kill his wife by cutting her throat, but that the attempt was not successful, and resulted in severing the auricular branch of the *second cervical nerve*, which supplies the ear, as well as the fifth cranial nerve. An opportunity was thus afforded to examine, by the use of needle points, the state of sensibility of the different portions of the ear, and to decide, by the loss of sensibility, the exact regions which the second cervical nerve supplied. It was thus proven that the *upper and anterior part* of the ear, and also the *auditory canal*, was supplied by the fifth cranial nerve; and that, therefore, these parts are in direct nervous communication with the forehead, temple, face, nose, teeth, and the tongue.

It can thus be easily understood why pain in the auricular region, as evidenced in cases recited later on, may prove a most valuable diagnostic sign of irritation of some of the other branches of the fifth nerve, distributed to the regions which are associated by means of this nerve with the ear, although apparently having no anatomical relation with it.

In the partly diagrammatic representation of the distribution of the nerves to the cutaneous surface of the head, the outlines of the various regions, represented as supplied by the different nerves, are as nearly accurate as careful investigation can determine them.<sup>2</sup> It will be perceived that *nine*, out of the fourteen regions mapped out upon the head and neck, are supplied with sensation by some of the branches of

<sup>1</sup> "Rest and Pain," London (New York, 1879).

<sup>2</sup> As the boundaries of the regions supplied by any nerve gradually shade off into neighboring regions, it is not well to rely upon the *extreme* area of any region in testing the special sensibility of any nerve.

the *fifth cranial nerve*, while the remaining five are supplied by branches of the cervical plexus, with the exception of that region to which the great occipital nerve is distributed.

It can easily be understood, from what has already been

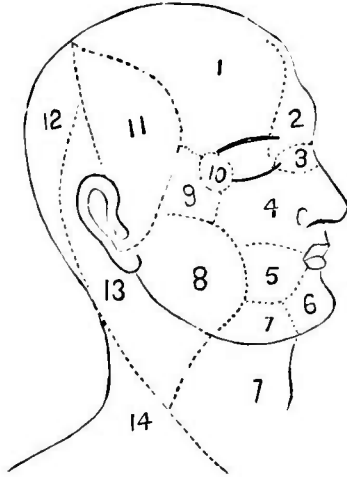

FIG. 58 — *The nervous distribution of the head.* (After Flower, but slightly modified.)

1, region supplied by the *supra-orbital* branch of the fifth nerve; 2, region supplied by the *supra-trochlear* branch of the fifth nerve; 3, region supplied by the *infra-trochlear* branch of the fifth nerve; 4, region supplied by the *infra-orbital* branch of the fifth nerve; 5, region supplied by the *buccal* branch of the fifth nerve; 6, region supplied by the *mental* branch of the fifth nerve; 7, region supplied by the *superficial cervical* from the cervical plexus; 8, region supplied by the *great auricular* from the cervical plexus; 9, region supplied by the *temporo-malar* branch of the fifth nerve; 10, region supplied by the *lacrimal* branch of the fifth nerve; 11, region supplied by the *auriculo-temporal* branch of the fifth nerve; 12, region supplied by the *great occipital* (a spinal nerve); 13, region supplied by the *small occipital* from the cervical plexus; 14, region supplied by the *supra-clavicular* from the cervical plexus.

said as to the manner of employing the nerves as guides to diagnosis, that a careful study of the limits of each of these regions of the head may often enable the physician to explain symptoms which might otherwise seem obscure; and also enable him to use the symptom of *local pain*, whenever present, as a signal which Nature often gives of disease in parts possibly far removed from the seat of pain, but still intimately connected to it by means of its nervous supply.

#### EFFECTS OF SECTION OF THE FIFTH NERVE.

Many points of practical value dependent upon the fifth nerve can be better understood when the effects of its division have been considered in detail. If the fifth nerve be divided, *sensation* is immediately destroyed in all those

portions of the head and face to which the efferent nerves are distributed ; the *power of mastication* is lost ; the *secretions* of the lachrymal, parotid, and submaxillary glands are rendered deficient ; the *act of deglutition* becomes imperfect, since some of the muscles required for its performance are paralyzed, and since the *tongue is unable to perceive* the bolus of food, and therefore can not properly direct its movements ; and, finally, *hearing* is, to a certain extent, impaired, since the tensor tympani muscle<sup>1</sup> has lost its motor power.

In addition to these direct effects of section, *secondary results* are manifested in those forms of ulceration which have been previously referred to, and, eventually, in the *destruction of sight and smell*.

It may be noticed that the effect of section of the fifth nerve upon the *special sense of taste* has not been mentioned. It was formerly supposed that the gustatory fibers of the fifth nerve afforded the sense of taste to the *anterior two thirds* of the tongue ; but it is now urged by many that the fifth nerve is simply a nerve of sensation to that organ, and that its fibers are employed exclusively in the appreciation of the sensations of touch and feeling, while the true gustatory fibers of that portion of the tongue are derived from the *chorda tympani* branch of the facial nerve. In support of this view, cases have been observed where the chorda tympani has been affected, either by disease or in consequence of injury within the middle ear, and the sense of taste has been impaired ; but, on the other hand, cases have been also recorded where the fifth nerve was alone diseased, and yet taste was destroyed in the anterior two thirds of the tongue. It is such cases as the latter that still lead some physiologists to believe that the chorda tympani nerve only controls the *flow of the saliva*, and that impairment of this secretion impairs or destroys the special sense of taste afforded by the gustatory branch of the fifth nerve.

<sup>1</sup> According to Lucae's recent experiments ("Berlin. klin. Wsehr.," 1874), the tensor tympani muscle presides over the *accommodation for musical tones*.

## CLINICAL POINTS AFFORDED BY THE FIFTH NERVE.

The fifth nerve may be the seat of neuralgia, spasm, or paralysis. The type of neuralgia (called *tic-douloureux*, the facial pain of Fothergill, and "*prosopalgia*") dependent upon the fifth nerve affects only the sensory trunks; the spasms may be of a tonic or clonic type, and are, of course, confined to the muscles supplied by the motor branches of the nerve; while the paralytic condition can affect the sensory trunks, producing anæsthesia of the parts to which the affected nerve is distributed, or the motor filaments may be impaired, thus destroying the power of normal movement in the muscles of mastication and the mylo-hyoid. So many points of clinical interest and practical value pertain to these various conditions that each will be considered somewhat in detail.

## NEURALGIA OF THE TRIGEMINUS NERVE.

The various forms of *tic-douloureux* are so commonly met with, and prove so obstinate to treatment, as well as distressing to the patient, that a practical knowledge of the disease can not be gained without a careful study of the various causes which have been found to produce it.

Among the reported cases of this affection, there have been discovered, as exciting causes, the following conditions: Tumors of the middle fossa of the skull or of the base of the brain, producing neuralgia so long as irritation only is produced, but anæsthesia when degeneration of the nerve trunks begins; accumulations of pus within the cranial cavity; tumors of the pons Varolii; morbid processes in the regions adjacent to the ganglion of Gasser; and aneurism of the internal carotid artery<sup>1</sup> within the sella turcica. Diseases of the cervical portion of the spinal cord, if high up, may create neuralgia of the fifth pair, by irritating the fibers of that nerve which arise from the lower part of the medulla. Periostitis of the bony orifices, through which the various branches of the fifth nerve pass, may create such pressure as to produce

<sup>1</sup> Romberg's case.

the most severe and persistent neuralgias ; for this reason the supra-orbital, infra-orbital, zygomatic, superior and inferior dental branches are more liable to be the seat of pain than the branches which pass through such large openings as the sphenoidal and spheno-maxillary fissures.<sup>1</sup> Exostoses of the bones, especially of the upper and lower jaws, may create the most severe type of neuralgia by pressure upon the neighboring nerve trunks. Exposure to cold or dampness will produce it, being one of the most frequent of the trivial causes. Finally, inflammatory changes in the ganglia<sup>2</sup> attached to the nerve, the enlargements and nodosities found upon resected nerves, an exostosis of a wisdom tooth,<sup>3</sup> caries and osteophytes of the bony canals through which branches of the nerve pass, and neuroma of the ganglion of Gasser protruding through the foramen ovale,<sup>4</sup> have been known to produce the most severe neuralgia.

The symptoms of tic-douloureux are of the most distressing character. The pain is usually extremely violent, and the patients will describe it to you as of a burning, piercing, or shooting character. It is liable to be, at first, paroxysmal ; but, if due to organic disease, it may gradually become more or less constant. The continuous pain is, however, usually limited to certain well-defined spots of extreme sensitiveness to pressure, which the patient can readily point out to you (the "*puncta dolorosa*" of Valleix). Thus, the first branch of the trigeminus (the ophthalmic) presents six such points, each indicating some one of its subdivisions. These are situated, respectively, over the supra-orbital foramen ; in the center of the upper eyelid ; a frontal point over the escape of the nerve of the same name ; one at the outer angle of the eye, for the lachrymal branch ; and two at the inner angle of the eye, upon the nose, representing the inferior trochlear and the ethmoidal nerves.

In the region supplied by the superior maxillary nerve and its branches, there may exist a malar point, an infra-

<sup>1</sup> Hyrtl, as quoted by Rosenthal.

<sup>2</sup> Cases of Carnochan and Wedl.

<sup>3</sup> Thompson, as quoted by Rosenthal.

<sup>4</sup> Chouppe's case.

orbital point, a point in the palate, and one on the gum of the upper jaw.

In the region of the inferior maxillary nerve, the points of tenderness are situated in front of the tragus of the ear (the temporal point); one in the parietal region, where the frontal, occipital, and temporal nerves meet; one over the temporo-maxillary joint; a point upon the tongue for the lingual branch; and one upon the integument of the chin, for the mental nerve.

Painful points are often detected by pressure in the region of the spinous and transverse processes of the cervical vertebræ (the "point apophysaire" of Trousseau).

These *puncta dolorosa* are usually the starting points for the pain of the acute paroxysms, from which the pain radiates along the course of the nerves of the region affected. In some cases, these points of tenderness may, however, be absent, when a central origin of the disease may reasonably be suspected.

The relation of the filaments of the fifth nerve with certain *vaso-motor fibers* causes this type of disease to be often associated with certain disorders of secretion, since the vessels of the glands of the affected region are liable to dilate after an acute paroxysm of pain. We can thus explain the abundant flow of tears after an attack of neuralgia of the ophthalmic branch; and of nasal mucus and saliva, when the second and third branches of the trigeminus are involved. Profuse sweating of the region of the face affected is also sometimes well marked both during and after the paroxysm.

The vaso-motor communication may also explain why we have reported cases of local swelling, redness, elevation of the temperature, and, sometimes, erysipelatous inflammation of the affected region; and why the hair has been observed to fall out, and the skin to become discolored and roughened. Hypertrophy of the cheek has been noticed, as a result of tic-douloureux, by Niemeyer, Brodie, Romberg, and Notta; and ophthalmia has been produced by a similar condition confined to the first branch of the fifth nerve. When the nerve trunks, which at first were the seat of neuralgia, become destroyed or

seriously impaired by pressure or granular degeneration, the face may undergo atrophy.

Neuralgias of the fifth nerve, when due to *cerebral tumors*, are often complicated by other symptoms which greatly assist in the diagnosis; among the more prominent of which may be mentioned diplopia, vertigo, chronic cephalalgia, spasms of certain groups of muscles, paralysis of various types, and the absence of the *puncta dolorosa*, whose situations have already been mentioned.

Tic-douloureux is not to be confounded with pain dependent upon the decay of teeth, inflammation of the temporo-maxillary articulation, tumors of the antrum, or extension of inflammation to that cavity from an acute attack of coryza, migraine, or the facial pains of lead poisoning, hysteria, or spinal affections. It is more common in women than in men; and most frequent between the ages of thirty and fifty. It is more liable to occur in cold months than when the weather is warm (provided it be not due to actual disease); and it may follow traumatism, senile changes in the blood-vessels, and malarial poisoning.

#### SPASM DUE TO THE TRIGEMINUS NERVE.

The jaw may be rendered immovable, as in tetanus, by the masseter, temporal, and pterygoid muscles, all of which are supplied with motor power by the fifth nerve. The same form of spasm may be occasionally observed in attacks of hysteria.

Clonic spasm of the temporal and masseter muscles, alternating with that of the depressors of the jaw (the mylo-hyoid and the anterior belly of the digastric), produces the *chattering of the teeth* so often seen in the chill of inflammatory diseases and fevers and after exposure to cold.

The pterygoid muscles, by a tonic contraction, may produce the *grinding* of the teeth; a displacement of the jaw to one side, during an hysterical paroxysm, which lasted some days, is reported by Leube.<sup>4</sup>

<sup>4</sup> As quoted by Rosenthal: "A Clinical Treatise of the Diseases of the Nervous System" (Putzel's translation, New York, 1879).



Spasms of the muscles supplied by the trigeminus may be the result of apoplexy, cerebral softening, meningeal exudation, lesions of the pons Varolii and medulla oblongata, hysteria, epilepsy, tetanus hysteria, hydrophobia, tumors irritating the ganglion of Gasser, peripheral irritation, reflex causes (as dental pain, ulceration of the tongue or mouth, intestinal or uterine irritation, teething, etc.), and rheumatism.

In rare cases, the *depressors of the jaw* may be the seat of localized spasm, in which event the mouth may be kept wide open for a longer or shorter period.

#### PARALYSIS OF THE TRIGEMINUS NERVE.

It is a rare occurrence to observe a simultaneous paralysis of the motor and sensory roots of the trigeminus; although anæsthesia of parts supplied by the branches derived from the sensory root may occur from central causes, and is perhaps more frequent than those symptoms dependent upon lesions involving the motor root. In lesions confined to the cerebral ganglia or cortex, however, the motor root is more often impaired than the sensory portion, while the sensory root, or some of its branches, is frequently affected from causes outside of the cranial cavity.

In studying the condition of trigeminal anæsthesia, it must be prefaced that the regions affected, and therefore the results of the impaired nervous function, differ with the exciting cause, since a central lesion is liable to involve all of the sensory branches of the nerve; while an external cause usually affects some individual branch.

The *central lesions* of this disease comprise apoplectic clots; destructive lesions producing ataxia; hysteria; local diseases or exudations which involve the large root of the fifth nerve between the pons Varolii and the ganglion of Gasser; and lesions of the medulla oblongata, thus affecting its fibers of origin.

The *external causes* include all forms of traumatism; exposure to cold or heat; surgical procedures; caries or periostitis of the bony canals; suppuration of the soft tissues ad-

joining the affected nerve; local tumors and inflammatory exudations; and certain blood conditions accompanied by nerve sclerosis (chiefly Norwegian leprosy).<sup>1</sup>

The condition of facial anæsthesia may be complete, when sensibility to contact, pain, heat, or cold is abolished; or partial, when extreme impressions can be perceived, and often differentiated as to the peculiar character of each. The needle points, the compass, and the electric brush are all employed in the examination of such a patient, in order to decide as to the extent, character, and degree of the existing paralysis.

If the *ophthalmic nerve* be the seat of anæsthesia, we may observe a contracted state of the pupil,<sup>2</sup> insensibility of the mucous lining and integument of the upper eyelid, insensibility of the skin of the forehead and the external and inferior parts of the nose, and a total absence of the sense of contact in the anterior portions of the mucous membrane of the nostril.

If the *superior maxillary nerve* alone be affected, the skin and mucous lining of the lower eyelid, the integument of the cheek, lower half of the nose, and the corresponding half of the upper lip, show an entire or partial abolition of sensibility; while the mucous membranes of the middle and posterior portions of the nasal cavity, of the roof of the palate, and the entire soft palate and uvula, are similarly affected. The teeth and gums of the upper jaw will also be in the anæsthetic condition.

If the *inferior maxillary nerve* be the seat of disease, without impairment of the motor root of the nerve, the integument of the outer surface of the ear, above the auditory canal,<sup>3</sup> of the temporal region, of the corresponding half of the lower lip, and in front of the temporo-maxillary articulation, will be destitute of sensibility. The mucous membrane of the corresponding side of the lower lip, tongue, cheek, tonsil, and gum of the lower jaw will be also anæsthetic, while the teeth of the

<sup>1</sup> See investigations of Daniellson and Boeck, as quoted by Rosenthal.

<sup>2</sup> For effects of nerve influences on the pupil, see page 133 of this volume.

<sup>3</sup> For researches of Hilton on this point, see page 158 of this volume.

corresponding side of the lower jaw will likewise be deprived of sensibility

If you will recall the points which were made in reference to the effects of section of the trigeminus, you will be better able to understand why paralysis of any portion of this nerve should be followed by symptoms of late development, due, apparently to some alteration in the nutrition and reactive power of the regions supplied by the nerve which is diseased. You will remember that the existence of certain unnamed fibers, called "trophic fibers," was mentioned, whose close connection with the sympathetic nerve is highly probable, and whose function seems to be to control and regulate the blood supply of the regions to which they pass. Now, it is clinically observed that the paralysis of any of the three large branches of the trigeminus is followed by certain ulcerative and suppurative processes in the regions rendered anæsthetic, and that these effects are the most prominent and serious when the ophthalmic nerve is affected.

Landmann and Bell were the first observers to point out that, in the human subject, purulent destruction of the eye was liable to follow pressure upon the trigeminus from tumors in the region of the ganglion of Gasser; while Magendie (1824), Bock (1844), Snellen (1858), Spencer Watson (1874), Samuel (1860), and Meissner have done much to bring the results of defective nutrition, following impairment of nerve supply, to professional notice. It might add much to the interest of this volume to enter into the details of the interesting experiments and clinical observation, which have now become quite extensive regarding this subject, but it will exceed the scope of this course to more than hastily sketch the results obtained. The opinion of Snellen, that the ulceration of the cornea and the suppurative conjunctivitis which follows anæsthesia of the ophthalmic nerve were the mechanical effects of the irritation of dirt which the conjunctiva was no longer capable of perceiving, seems to have been confirmed by Watson<sup>1</sup> and Baerwinkel,<sup>2</sup> who found that an artificial cleans-

<sup>1</sup> "Med. Times," 1874.

<sup>2</sup> "Arch. f. klin. Med.," 1874.

ing and closure of the eyelids caused recovery, without any effect upon the nerve condition. It was apparently also proven by Bock and Samuel that the condition of anæsthesia was not necessary to the development of these later processes, resulting in destruction of tissue, since the same results were observed when hyperæsthesia existed. In reference to the course of the "trophic fibers" of the ophthalmic nerve, the researches of Meissner and Schiff<sup>1</sup> seem to locate their situation in the central portion of the nerve, since the other parts seem to preside over sensation only. Finally, the interesting experiments of Sinitzin,<sup>2</sup> made in 1871, show some remarkable effects of the removal of the superior cervical ganglion of the sympathetic nerve upon trigeminal ophthalmia; since it was often cured when once started, and prevented in every case where it was done before the trigeminus was divided.

We know, irrespective of the theories of its causation, that the destruction of the sensory root of the fifth nerve is liable to be followed by destruction of sight, interference with the sense of smell, ulceration of the nose and gums, a tendency to inflammation and abscess of the soft tissues, and, possibly, to gangrene.

It is of practical importance, however, to discriminate between that form of trigeminal anæsthesia dependent upon *central lesions* and that due to *external pressure or disease*.

We may remember that the *central form* is usually confined to the inferior maxillary portion of the nerve; that a previous history of cerebral disease will often be found; that paresis or paralysis of the muscles of the face, tongue, jaws, or limbs will possibly coexist; and that, if the lesion be a tumor at the base of the cerebrum, cephalalgia, neuralgias of special branches of the trigeminus, and a simultaneous affection of some of the adjacent nerves of the cranium may be discovered.

If the cause is *outside of the cranium* (provided it be not due to syphilis, rheumatic diathesis or traumatism), we may expect to find evidences of the previous existence of abscess,

<sup>1</sup> "Centralbl.," 1867.

<sup>2</sup> "Med. Centralbl.," 1871.

periostitis of some of the osseous canals through which the various branches of the trigeminus pass, or of local tumors which are creating pressure upon some nerve trunk or its terminal filaments.

The *motor root of the fifth nerve may be impaired* from the pressure exerted by meningeal exudation, extravasations of blood, or tumors within the cranium; while it is frequently involved (after the sensory portion of the trigeminus) during the development of some type of basilar affection. The results are manifested by a paralysis of the muscles of mastication upon the side where the nerve is diseased, except the buccinator muscle, which derives its motor power from the facial nerve. The healthy muscles of the opposite side tend to crowd the lower jaw toward the affected side of the face during mastication, giving a peculiar expression during the act of eating.

#### DIAGNOSTIC VALUE OF THE FIFTH NERVE.

To what extent the distribution of the fifth nerve is of practical value in diagnosis may be estimated by the perusal of the lectures<sup>1</sup> of Sir John Hilton upon the significance of pain and the use of rest as its cure. Cases have been reported by Paget, in his lectures on surgical pathology, and also by Anstie,<sup>2</sup> where the hair of the entire scalp has turned white after a severe attack of neuralgic headache; and another is reported by Anstie, where the *hair of the eyebrow* alone became perfectly blanched from pain in that region dependent upon the supra-orbital nerve. Hilton reports a case where the *hair of the temple*, from the irritation excited in the dental branches of the fifth nerve through a decayed molar tooth, became suddenly gray (the temple being the region supplied by the auriculo-temporal branch of the same nerve); and another where an obstinate form of ulcer in the auditory canal, which was very painful, and had withstood all methods of treatment, was cured by the extraction of a decayed tooth in the upper jaw; again illustrating the fact that irritation of

<sup>1</sup> "Rest and Pain," London (New York, 1879).

<sup>2</sup> "Lancet," 1866.

one branch (the dental) can create disease at the seat of distribution of another branch of the same nerve (the auriculo-temporal).

The *temporo-maxillary articulation* has often been known to assume a condition of immobility during an attack of ear-ache, and to be immediately relieved by the application of an anodyne to the terminal filaments of the fifth nerve in the canal; thus illustrating the effect of irritation of one branch (the auriculo-temporal) upon the others which supply the muscles of mastication, causing them to contract and thus fix the joint.

Again, a *furred condition* of the *lateral half of the tongue* may almost be considered a pathognomonic sign of some source of irritation to the fifth nerve, which thus manifests itself in the peripheral distribution of one of its branches (the gustatory nerve).<sup>1</sup>

Chronic *ulceration of the cornea* has also been reported by Anstie as a symptom produced by some source of irritation of the fifth nerve, far removed from the seat of disease.

The intimate communication of the internal portions of the mouth with the eye, ear, and nose often accounts for many curious symptoms, which it would be difficult to account for, did we not know that pain may be *felt at any branch* of a nerve, when one of its trunks is irritated. I have, at the present time, a patient under my care, who is suffering from an obstinate ulceration of the tongue, and who had, previous to his consulting me, been treated for an inflammatory condition of the ear, on account of a constant and severe pain, which was considered as separate and distinct from the trouble which was, at the same time, affecting his tongue. A simple gargle of opium, which I ordered him to hold for fifteen minutes in his mouth at intervals, relieved the symptom in a very short time.

A case is reported by Hilton where an *enlarged cervical gland* appeared with a simultaneous *discharge* from the *auditory canal*, and where the explanation, by which a decayed

<sup>1</sup> Bransby Cooper; John Hilton.

tooth was diagnosed as the cause of the condition, was as follows: The irritated dental branches of the fifth nerve caused an inflammation of the auditory canal, which is supplied by another branch (the auricular of the auriculo-temporal); this inflammation was followed by suppuration and excoriation of that canal, and, subsequently, by absorption of the discharges by the lymphatic vessels, thus producing the enlarged gland of the neck. This explanation may seem a roundabout way of reaching a diagnosis, but the result of drawing the tooth proved, in this case, how well anatomy may guide us, if we only follow its teachings.

Earache may not always be due to the fifth nerve, even when it is confined to the external portion of the organ, since the second cervical nerve supplies the *lower and back part* of the external ear, so that pain in that region should lead us also to look for some cause of irritation to that nerve.

The distribution of nerves to the scalp, as shown in the figure on page 159, renders the symptom of pain, in any portion of the scalp, one which may guide us in looking for its cause; since, if it is confined to the *anterior and lateral aspects* of the head, the fifth nerve is probably affected by some source of irritation (and a reference to the cut will tell you which branch of the nerve is distributed to the seat of pain), while, if confined to the *posterior portion* of the scalp, the occipital nerves are affected, and disease of the spine may be suspected, in the region of the first or second cervical vertebræ.

The distribution of the fifth nerve to the *conjunctiva*, both of the globe of the eye and also of the lids, exhibits, to a wonderful degree, the axiom given you in the first lecture of the course, as to the harmony of action between the sensory nerves of the skin, the muscles adjacent, and the joints which they move; since these parts stand very much in the same general relation to each other, if the movable point in the eyelids be taken as a joint, and the muscles of the lids as those which move it.

An analogy has been drawn by a prominent author<sup>1</sup> between a common two-rooted spinal nerve and a great "compound nerve" of the head, whose *sensory root* corresponds to the sensory portion of the fifth nerve, and whose *motor root* comprises the third, fourth, fifth (its motor portion), sixth, and seventh cranial nerves, which, together, form the motor root of this compound nerve. Most of the reflex acts which are exhibited in the regions of the head and the upper portion of the neck can be explained by the free communication which exists between the sensory root of this "compound nerve" and its different motor branches.

It seems useless to further incorporate such cases, which go to prove that only by a thorough familiarity with anatomy are we enabled to explain the many phenomena which often puzzle the practitioner; and that, if we will but use it as a guide, diagnosis may be greatly simplified, and an easy remedy often discovered for the symptoms.

#### SURGICAL ANATOMY OF THE FIFTH NERVE.

Surgical operations are often demanded for the relief of those tormenting neuralgias which affect the branches of the fifth nerve.

The simple division of a nerve is, at present, seldom practiced, owing to the certainty of prompt reunion of the nerve divided. Resection of not less than *two inches of its length* is usually required to make reunion impossible, or very remote in point of time. It has been proposed to turn the peripheral extremity of the nerve backward after section, or to interpose muscle or fascia, to prevent the possibility of union.<sup>2</sup> Exposure and stretching of spinal nerves for the relief of neuralgia have been proposed by Von Nussbaum, but are not usually practiced upon the cranial nerves.

The *supra-orbital nerve* may be thus divided :

Pass a narrow knife, subcutaneously, from a point two or three lines on the inner side of the *supra-orbital notch*, out-

<sup>1</sup> John Hilton, "Rest and Pain."

<sup>2</sup> S. W. Mitchell.



ward, until the point has passed beyond the notch; then turn the blade backward, and cut down to the bone. To resect the nerve, make a one-inch incision above and parallel to the supra-orbital arch; seize the cut ends of the nerve in the wound, and remove it to the desired extent.<sup>1</sup>

To excise the *superior maxillary nerve*, a crucial incision is made over the *infra-orbital foramen*, and, by the use of a small trephine, the anterior wall of the antrum is opened so as to include the foramen. The lower wall of the infra-orbital canal is now broken with a chisel as far as the sphenomaxillary fossa, and the nerve is then *divided* at the *foramen rotundum* with a pair of scissors sharply curved. Meckel's ganglion is frequently removed with the excised nerve.<sup>2</sup>

To divide the *inferior dental nerve*, the incision may be made within the mouth or externally. If the trunk is to be removed, before the nerve enters the canal in the lower jaw, the external incision is made from the *sigmoid notch* to the edge of the jaw. The parotid gland is then turned backward, and the lower portion of the masseter muscle detached. A section of bone is now removed with a trephine, and the dental artery is tied, in case it be wounded; the nerve may then be divided, and a half inch of it, which will be found to be exposed, resected.

In the *intra-buccal operation*, the corner of the mouth is held wide open, and an incision one inch in length is made along the *anterior* part of the *ramus* of the jaw, through the fibers of the internal pterygoid muscle. This muscle is then loosened from the periosteum by the finger, where the nerve can be easily felt, at its entrance into the dental canal, and there divided.

#### THE GANGLIA CONNECTED WITH THE FIFTH NERVE.

In the cut which illustrates the distribution of the branches of the fifth nerve will be perceived four ganglionic enlarge-

<sup>1</sup> J. N. Warren.

<sup>2</sup> J. R. Wood.

ments, exclusive of the ganglion of Gasser, which are connected with the nerve, and which have a most important function as regards the tissues to which these branches are distributed.

As you will notice, the first is connected with the ophthalmic division, and is situated within the orbit. It is called the "ophthalmic ganglion," from its attachment; also the "lenticular ganglion," from its shape; and the "ciliary ganglion," since it gives off the ciliary nerves to the iris and the muscle of accommodation of vision. Like all the ganglia of the sympathetic nerve, it has a *motor root*, a *sensory root*, and a *sympathetic root*, and it furnishes *branches of distribution* to neighboring parts.

The second is called "Meckel's ganglion," after its discoverer; and the "spheno-palatine ganglion," since it is chiefly distributed to the region of the palate. It is situated in the *spheno-maxillary fossa*, and sends branches to the orbit, nose, hard and soft palate. It lies in close relation with the superior maxillary nerve.

The third is called the "otic ganglion." It lies upon the inferior maxillary nerve *below the foramen ovale*, and sends branches to the two tensor muscles, viz., the tensor tympani and the tensor palati. It is thus physiologically associated with the acts of *hearing* and *deglutition*.

The fourth is called the "submaxillary ganglion," since it lies above the submaxillary gland. It is by means of the distribution of the *chorda tympani nerve* to this ganglion that some physiologists attempt to explain the apparent effect which that nerve has upon the sense of taste in the anterior two thirds of the tongue.<sup>1</sup>

The following table<sup>2</sup> will perhaps assist you in remembering the special points of each of these ganglia, as it shows the various sources of supply to each, as well as branches of distribution:

<sup>1</sup> See previous portion of this chapter, where the gustatory nerve is discussed.

<sup>2</sup> After Keen.

THE GANGLIA OF THE FIFTH CRANIAL NERVE.

Name.	Situation.	Sensory root.	Motor root.	Sympathetic root.	Branches of d. tribut. n.	
OPHTHALMIC or CILIARY.	Between the optic nerve and <i>ext. rectus</i> .	5TH NERVE—Nasal branch.	3D NERVE.	CAVERNOSUS PLEXUS	To ciliary muscle and iris.	
CEREBRAL GANGLIA.	MECKEL'S or SPHENO-PALATINE.	<i>Sphenomaxillary fossa</i> .	5TH NERVE— <i>Spheno-palatine</i> branches.	5TH NERVE, through <i>Vidian</i> and <i>large petrosal</i> branches.	CAROTID PLEXUS, by means of <i>Vidian nerve</i> .	Orbital, nasal, naso-palatine, anterior or large palatine, middle or external palatine. Post. or Levator palati, small Azygos uvulae, palatine Palato-glossus
	OTIC.	Below the <i>Joramen ovale</i> .	5TH NERVE— <i>Auriculo-temporal</i> branch.	5TH NERVE, through <i>small petrosal</i> . 5TH NERVE, through <i>int. pterygoid</i> branch.	PLEXUS ON the MIDDLE MENINGEAL ARTERY.	To tensor tympani and tensor palati muscles.
	SUBMAXILLARY.	Above the <i>submaxillary gland</i> .	5TH NERVE— <i>Lingual</i> or <i>gustatory</i> branch.	5TH NERVE, through <i>chor. da tympani</i> branch.	PLEXUS ON the FACIAL ARTERY.	To submaxillary gland and mucous membrane of the mouth.

By reference to the above table, you will perceive that the *sensory root* of each of the four ganglia is derived from the *fifth* cranial nerve by means of some of its branches; that the *motor root* is derived, in three cases out of four, from the *seventh* cranial nerve; and, finally, that in every case is the sympathetic root derived from a *plexus* upon some neighboring blood-vessel.

THE ABDUCENS, OR SIXTH NERVE (MOTOR OCULI EXTERNUS).

The apparent origin of this nerve is from a *groove* between the *anterior pyramid* of the medulla oblongata and the *posterior border* of the *pons Varolii*. The nerve may be said to possess two roots, one of which can be traced into the pyramidal body of the medulla, and the other into the *pons Varolii* itself. This latter root is sometimes wanting.

Its deep origin has been traced by Lockhart Clarke to a nucleus in the gray matter of the fourth ventricle of the brain, on the outer side of the *locus caeruleus*.

This nerve is purely motor in its function, and is distributed to the external rectus muscle of the eye.

The most careful researches of Vulpian have as yet failed to discover any decussation of the deep fibers of this nerve, and there would seem to be a physiological explanation for the absence of such an arrangement, since the two external recti muscles are seldom called into simultaneous action, and the normal movements of the eyes are opposed to such a position as would ensue if they should act in common.

The sixth nerve anastomoses with the *sympathetic nerve* in the cavernous sinus, where it receives filaments from both the carotid plexus and from Meckel's ganglion; and a few sensory filaments are said to be given to it from the ophthalmic branch of the fifth cranial nerve in this locality.

Occasionally, this nerve sends a filament to the *ophthalmic ganglion*, and thus to the *iris*, and it is claimed by Longet that this arrangement (which is an exceptional one) exists in those cases of paralysis of the motor oculi nerve in which there is no apparent effect produced upon the mobility of the pupil.

This nerve has no practical importance to the diagnostician, save the one fact that, in case it be paralyzed, the eye will present the condition of *internal strabismus*; that the *apparent size* of the objects perceived by the retina is *magnified*,<sup>2</sup> and that the head will be so deflected as to avoid the perception of double images.<sup>3</sup>

The explanation of both of these effects, as the result of

<sup>1</sup> After the eyes have been drawn inward, as in attempts to focus near objects, these muscles help to restore the axes of vision to a state of parallelism.

<sup>2</sup> For explanation of this symptom, the reader is referred to page 143 of this volume.

<sup>3</sup> See page 140 of this volume.

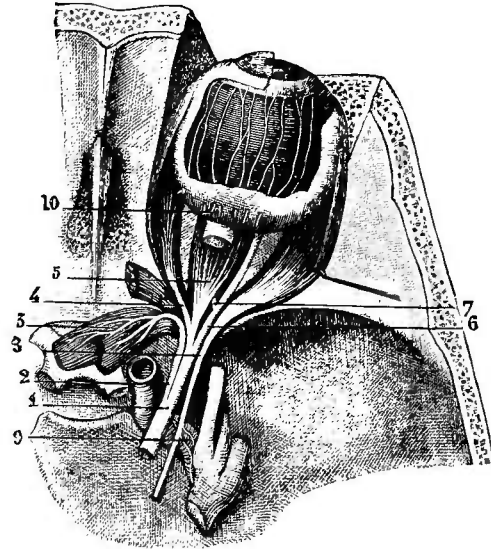

FIG. 59.—Distribution of the motor oculi externus. (Hirschfeld.)

1, trunk of the motor oculi communis, with its branches (2, 3, 4, 5, 6, 7); 8, motor oculi externus, passing to the external rectus muscle; 9, filaments of the motor oculi externus anastomosing with the sympathetic; 10, ciliary nerves.

paresis of certain ocular muscles, has already been given in the previous lecture upon the third cranial nerve, and need not be again repeated. It should not be forgotten, however, that internal strabismus is not always due to paralysis of the external rectus muscle, but may indicate a condition of congenital or acquired hyperopia, causing a weakness of the external rectus muscle.

#### THE FACIAL, OR SEVENTH NERVE.

This nerve has its apparent origin from a *groove* between the *olivary* and *restiform bodies* of the medulla oblongata, and, like the three preceding, has its deep origin in a gray *nucleus* in the floor of the fourth ventricle, in the upper half of that space near to the postero-median fissure.<sup>1</sup> The filaments of origin, within the substance of the medulla oblongata, may be traced as a fan-like expansion upon the floor of the fourth ventricle, some of which terminate in the gray nucleus, above described, of the same side as that on which the nerve escapes, while other fibers may be seen to *decussate*, thus passing to the nucleus of the opposite side. No filaments have as yet been satisfactorily traced upward beyond the limits of the medulla.<sup>2</sup> This nerve accompanies the nerve of hearing throughout the whole length of the *internal auditory canal*, and there communicates with it by a few filaments. It then enters a curved canal within the temporal bone, called the *aqueduct of Fallopius*, where it gives off the three petrosal nerves and the chorda tympani branch, whose physiological action has been already considered in connection with the fifth nerve. From this canal, it escapes through the *stylo-mastoid foramen*, having, before its exit, given a tympanic

<sup>1</sup> Lockhart Clarke. An accessory portion of this nerve—the “*nerve of Wisberg*”—conveys fibers to it, whose deep origin may be traced to the lateral column of the cord. Its importance is now being extensively discussed, as having a connection with the chorda tympani nerve.

<sup>2</sup> The deep origin of the fibers of the facial nerve seems to have some connection with the upper portions of the encephalon (as shown by the clinical facts mentioned in previous pages, when discussing “crossed paralysis”); but little is, as yet, positively known concerning the course and termination of these fibers.

branch to the ear. In the region of the stylo-mastoid foramen, it *communicates with five nerves*, namely, the great auricular (a branch of the cervical plexus), the auriculo-tem-

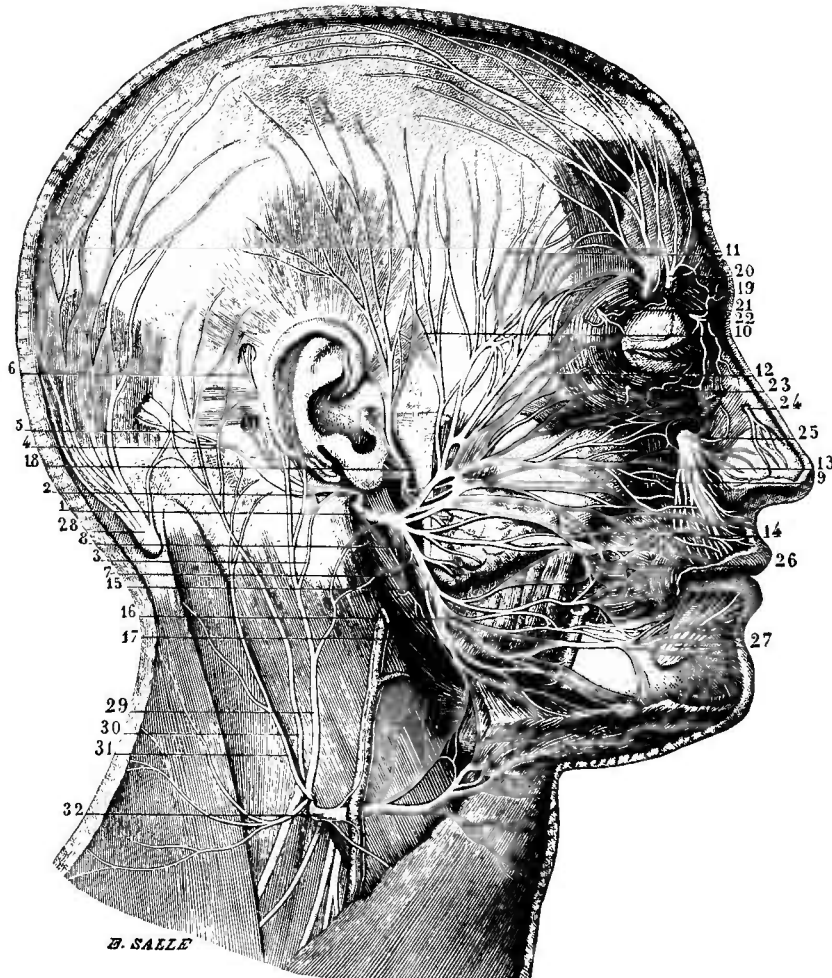

FIG. 60.—Superficial branches of the facial and the fifth. (Hirschfeld.)

- 1, trunk of the facial ; 2, posterior auricular nerve ; 3, branch which it receives from the cervical plexus ; 4, occipital branch ; 5, 6, branches to the muscles of the ear ; 7, digastric branches ; 8, branch to the stylo-hyoid muscle ; 9, superior terminal branch ; 10, temporal branches ; 11, frontal branches ; 12, branches to the orbicularis palpebrarum ; 13, nasal, or suborbital branches ; 14, buccal branches ; 15, inferior terminal branch ; 16, mental branches ; 17, cervical branches ; 18, superficial temporal nerve (branch of the fifth) ; 19, 20, frontal nerves (branches of the fifth) ; 21, 22, 23, 24, 25, 26, 27, branches of the fifth ; 28, 29, 30, 31, 32, branches of the cervical nerves.

poral (a branch of the fifth nerve), the pneumogastric, the glosso-pharyngeal, and the carotid plexus of the sympathetic ; and, subsequently, it divides and is distributed to the muscles.

The facial is the great motor nerve of the muscles of the

<sup>1</sup> Occasionally also the *filament of communication* to the pneumogastric nerve.

face; hence the *nerve of expression*.<sup>1</sup> It supplies, in addition to the facial muscles, the muscles of the external ear;

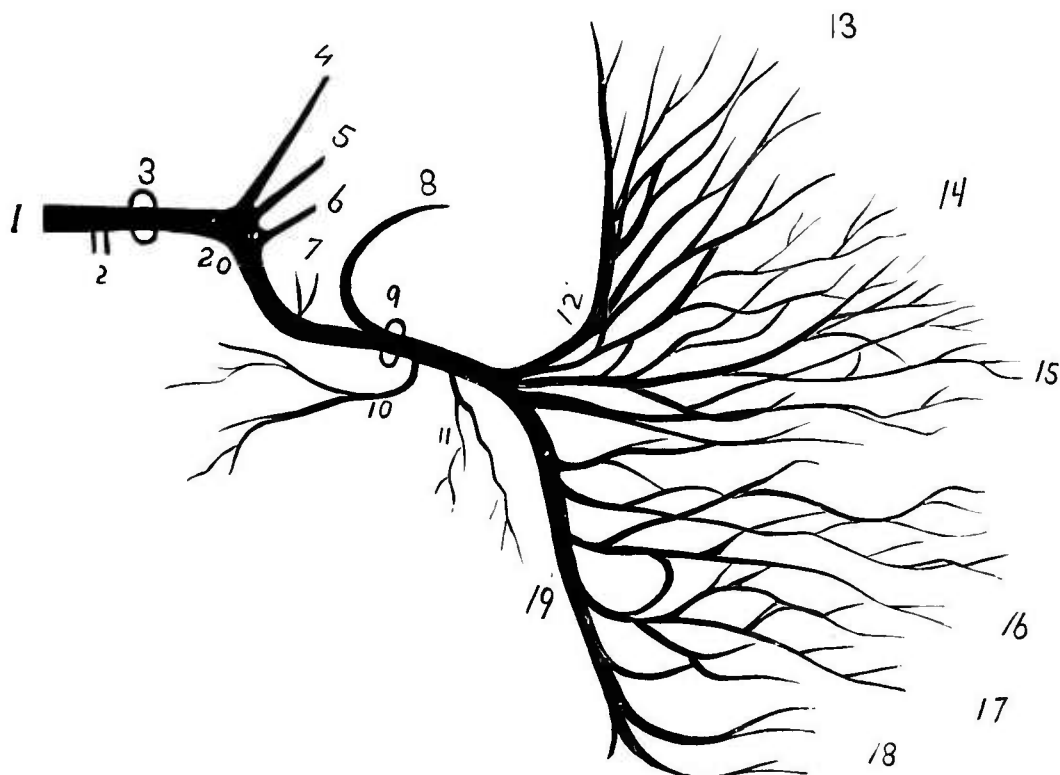

FIG. 61.—A diagram of the branches of the facial nerve.

1, main trunk of nerve in internal auditory canal; 2, branches of communication with AUDITORY NERVE; 3, orifice of aqueduct of Fallopius; 4, large petrosal nerve; 5, small petrosal nerve; 6, external petrosal nerve; 7, filaments to the *laxator tympani* muscles; 8, *chorda tympani* nerve; 9, stylo-mastoid foramen; 10, *posterior auricular nerve*; 11, filament supplying the *stylo hyoid* and *digastric* muscles; 12, the TEMPORO-FACIAL division of the nerve; 13, the *temporal* branches; 14, the *malar* branches; 15, the *infra-orbital* branches; 16, the *buccal* branches; 17, the *supra-maxillary* branches; 18, the *infra-maxillary* branches; 19, the CERVICO-FACIAL division; 20, "*intumescencia gangliiformis*"—the seat of origin of the petrosal nerves.

three muscles of the neck, namely, the stylo-hyoid, posterior belly of the digastric, and the platysma; one muscle of the middle ear, the stapedius; and one muscle of the palate, the levator palati.<sup>2</sup> By means of the chorda tympani branch, it controls the secretion of the parotid and submaxillary glands, and, possibly, the sense of taste.<sup>3</sup> By the large pe-

<sup>1</sup> Sir Charles Bell.

<sup>2</sup> Schiff, 1851; Bernard. Possibly also some other muscles, by means of the lingual branch, described by Hirschberg.

<sup>3</sup> Sappey; Hirschfeld; A. Flint, Jr.; J. C. Dalton. The fibers of the chorda tympani nerve, by some of the later authorities, are said to arise from an intermediate nerve formed by a branch from both the seventh and eighth cranial nerves, and called the "*portio intermedia*" or "*nerve of Wrisberg*."

trosal branch, the levator palati and azygos uvulæ are supplied; and, by the small petrosal branch, the tensor tympani and tensor palati muscles are furnished with motor power.

Several interesting articles have lately appeared upon the subject.<sup>1</sup>

It is claimed by Vulpian that the facial nerve also contains *vaso-motor fibers*, which are distributed to the vessels of the tongue and side of the face.

The effects of paralysis of the facial nerve were first brought to professional notice by Sir Charles Bell, who divided it for facial neuralgia, and the characteristic deformity which resulted is still known under the name of "Bell's paralysis." In this condition, the affected side loses its normal expression, and becomes abnormally smooth on account of the obliteration of the normal lines and wrinkles, due to the action of the antagonistic muscles on the healthy side.<sup>2</sup> The patient loses all power of closing the eye of the affected side even in sleep, since the orbicularis palpebrarum muscle is paralyzed; the mouth is no longer symmetrical, since it is drawn toward the healthy side; the saliva is with difficulty retained; and the act of whistling becomes an impossibility, as the lips can not be systematically governed. This condition may be produced by exposure to severe cold, as in sleigh-riding; by abscess or tumors of the parotid region, as the result of the pressure created; by diseases of the ear or injuries to the temporal bone, which impede the free action of the nerve; and by cranial lesions. It is particularly important that the surgeon should familiarize himself, not only with the situation and course of the main trunk of this nerve, but also with the course of its branches, previous to performing operations about the face, or in the vicinity of the mastoid process, and in the upper portions of the neck.

<sup>1</sup> Vulpian, "Lancet," 1878; H. R. Bigelow, "Brain," 1876; E. C. Spitzka "Medical Record," 1880.

<sup>2</sup> Hence the aptness of the remark by Romberg, as quoted by Hammond, that "there is no better cosmetic for elderly ladies than facial paralysis."



The distribution of this nerve to the muscles of the palate and to the stylo-hyoid explains the *impairment of deglutition* when the facial nerve is paralyzed; while the filament to the stapedius muscle may create modifications in the *sense of hearing* under similar conditions.<sup>1</sup>



FIG. 62.—*Bell's paralysis.* (Modified from Corfe.)

The following tabulated arrangement of the branches of the seventh nerve<sup>2</sup> will possibly prove of service to you as an aid to memory during your student life; and, as a guide for reference or review in your professional labors, such tables are always of value:

<sup>1</sup> The *tensor tympani muscle* may also be involved.

<sup>2</sup> Copied from "The Essentials of Anatomy": Darling and Ranney, New York, 1880.

TABLE OF THE BRANCHES OF THE FACIAL NERVE.

SEVENTH CRANIAL, OR FACIAL NERVE.	{ Branches of communication.	{	In the <i>auditory canal</i> .	Branch to auditory nerve.
		{	In the <i>aqueduct of Fallopius</i> .	{ <i>Large petrosal</i> (to Meckel's ganglion). <i>Small petrosal</i> (to otic gangl'n). <i>External petrosal</i> (to meningeal plexus). Tympanic branch.
		{	At its exit from the <i>stylo-mastoid foramen</i> , with the following nerves :	{ Great auricular. Auriculo-temporal. Pneumogastric. <sup>1</sup> Glosso-pharyngeal. Carotid plexus.
		{	On the face.	Branches to fifth cranial nerve.
	{ Branches of distribution.	{	In the <i>aqueduct of Fallopius</i> .	{ <i>Tympanic nerve</i> . <i>Chorda tympani nerve</i> . Posterior auricular nerve.
		{	Near the <i>stylo-mastoid foramen</i> .	{ Diaphragmatic branch. Stylo-hyoid branch. <i>Lingual branch</i> . <sup>2</sup>
		{	On the face.	{ Temporo-facial nerve. Cervico-facial nerve.

If you will look at this diagrammatic drawing (Fig. 63), you will perceive how simple is the arrangement of the *branches of communication* between the facial nerve and the fifth cranial nerve and its ganglia. While the drawing is intended to be purely schematic, still it also illustrates some of the anatomical points pertaining to the course and formation of the *Vidian nerve*, as well as the relations of the *chorda tympani nerve* to the *membrana tympani*, as it passes through the middle ear to reach the canal of Huguier.

There is a practical point pertaining to the *deep origin* of the fibers of the facial nerve, which may often be of value in determining the seat of pathological lesions within the substance of the brain. In hemiplegia, especially in that variety which is due to hæmorrhage, the face is sometimes affected upon the same side as the body and sometimes upon the opposite side, thus being impaired, respectively, either upon the side opposite to the cerebral lesion or upon the same side as the lesion. To explain these phenomena theoretically, we

<sup>1</sup> This communicating filament is given off in the *aqueduct of Fallopius* as often as at the stylo-mastoid foramen.

<sup>2</sup> Described by Hirschberg. Supplies the *stylo-glossus* and *palato-glossus* muscles and the tongue.

must suppose that the facial nerve fibers are affected by the lesion within the brain *before they decussate* (following them from within outward), in case the face is paralyzed on the *same side as the lesion*; and that the *decussating fibers* are

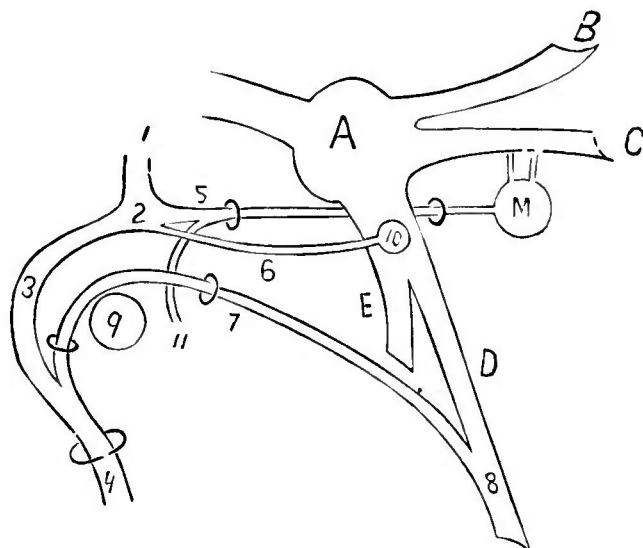

FIG. 63.—A diagram to show the relations between the facial nerve and some portions of the fifth nerve.

A, Gasserian ganglion; B, ophthalmic nerve; C, superior maxillary nerve; D, inferior maxillary nerve (sensory portion); E, inferior maxillary nerve (motor portion); M, Meekel's ganglion; 1, *facial nerve*, entering the *aqueduct of Fallopius*; 2, *intumescencia ganglioformis* (an enlargement on the nerve); 3, *facial nerve*, following the curve of the aqueduct of Fallopius; 4, *facial nerve*, escaping from *stylo-mastoid foramen*; 5, *large petrosal branch*, joining *carotid filament 11* to form the *Vidian nerve*, and entering the *Vidian canal*; 6, *small petrosal branch*, going to "*otic ganglion*" 10; 7, *chorda tympani nerve*, escaping from the *canal of Huguier* after winding over the upper border of *drum membrane of ear*, 9; 8, *gustatory nerve*, joining with the *chorda tympani nerve*; 9, *external drum membrane of the ear*; 10, *otic ganglion*; 11, *filament from carotid plexus to form the Vidian nerve*; 12, the *iter chordæ posterioris*, admitting the *chorda tympani nerve* into the cavity of the middle ear.

pressed upon or destroyed by the lesion, in case the face be affected on the *same side as the body*.

Now, it has been observed as a pathological fact, that when a lesion involves parts of the encephalon *anterior* to the pons Varolii, the phenomena dependent upon paralysis of the facial nerve are perceived on the same side as the hemiplegia; while, if the lesion be situated either in the lower part<sup>1</sup> of the pons Varolii or below it, the face is paralyzed on the same side as the lesion, or on the side opposite to the hemiplegia.

<sup>1</sup> Gubler has shown that the facial nerve is not paralyzed upon the same side as the lesion, if the injury to the pons Varolii be anterior to the imaginary line drawn through the points of escape of the trigemini.

For this reason, the occurrence of hemiplegia, with *crossed facial paralysis*<sup>1</sup> has been received as a most positive indication of a lesion situated upon the same side of the brain as that of the face, and either within the substance of the pons Varolii or in parts of the encephalon posterior to it. Such clinical facts as these seem positively to indicate that some of the deep fibers of the facial nerve pass *upward into the cerebrum*, and that the decussation of the filaments of origin within the floor of the fourth ventricle is of little physiological importance compared to these other fibers; but, unfortunately, no anatomical investigations have, so far, discovered fibers of this nerve which could be clearly demonstrated as passing upward beyond the pons Varolii.

It has been often noticed by different observers that, in case the facial nerve was paralyzed, the *uvula* and *soft palate* were affected and drawn toward the healthy side by the antagonistic muscles, whose motor power remained unimpaired. Later investigation has shown, however, that this affection of the palate only occurs in those cases of paralysis due to impairment of the facial nerve within the *aqueduct of Fallopius*, or from some cranial lesion which affects its *filaments of origin*.<sup>2</sup>

The experiments of Bernard seem to demonstrate that the *facial nerve*, and not the glosso-pharyngeal alone, is connected with movements of the *velum palati*, but not with the movements of the pillars of the fauces. The construction of the small petrosal branch, however, being composed partly of fibers derived from the glosso-pharyngeal nerve, may still justify a doubt upon this point.

Hirschfeld describes a small filament, which the facial nerve gives off soon after it emerges from the stylo-mastoid foramen, "*the lingual branch*,"<sup>3</sup> which is distributed to the tongue and to the *stylo-glossus* and *palato-glossus* muscles.

<sup>1</sup> A term used to cover those terms of paralysis where the face is paralyzed on the side opposite to the side of the body affected. See diagram on page 60.

<sup>2</sup> The petrosal nerves, which carry the motor fibers to these muscles, must be impaired to cause any deflection of the palate.

<sup>3</sup> See table on page 182.

This may possibly explain the observation of Bernard: that paralysis of the facial nerve, after section, produces a deviation of the *tip of the tongue*; and the same effect has been, at different times, recorded as the result of paralysis of the facial nerve from intra-cranial causes.

## BRANCHES OF COMMUNICATION OF THE FACIAL NERVE.

Some of the branches of communication which are given off by the facial nerve, to join with other nerves, or to be distributed to ganglia, are of physiological importance. Thus the *levator palati* and the *azygos uvulae* muscles derive their motor power from the *large petrosal* branch after it enters Meckel's ganglion;<sup>1</sup> while the *palato-glossus* and *palato-pharyngeus* muscles probably derived their motor power

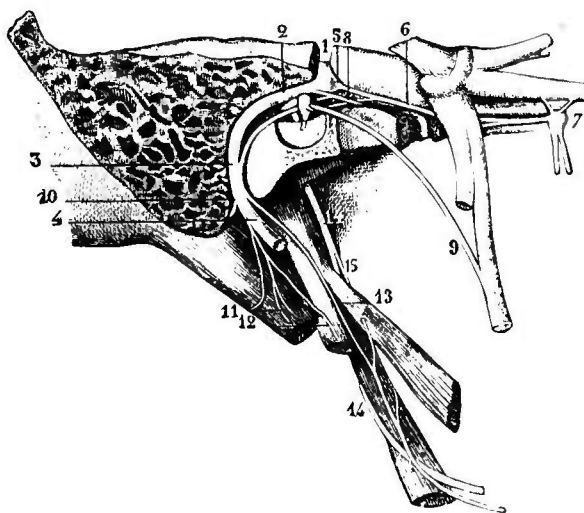

FIG. 64.—*Chorda tympani* nerve. (Hirschfeld.)

1, 2, 3, 4, facial nerve passing through the aqueductus Fallopii; 5, ganglioform enlargement; 6, great petrosal nerve; 7, spheno-palatine ganglion; 8, small petrosal nerve; 9, *chorda tympani*; 10, 11, 12, 13, various branches of the facial; 14, 14, 15, glossopharyngeal nerve.

from the communicating filament between the facial and the glosso-pharyngeal nerves, as shown by Longet. This distribution explains, in part, why more or less difficulty is perceived in *deglutition* after division or paralysis of the facial nerve, and still more clearly why the *pronunciation of certain words* becomes impaired, and the expulsion of mucus from the back

<sup>1</sup> Gray, Quain, Sappey, and others.

portion of the mouth and from the pharynx is an act of extreme difficulty.

The communication of the cervical plexus with the *posterior auricular* branch of the facial affords *sensory filaments* to the parts over the muscles which that nerve supplies.

The filament of communication between the *facial* and the *auditory* nerves enables the muscle of the middle ear supplied by the facial<sup>1</sup> to act in harmony with the acoustic apparatus; while the communication between the *fifth nerve* and the *facial* enables the latter to follow that general axiom<sup>2</sup> of nerve distribution by which the skin over the insertion of

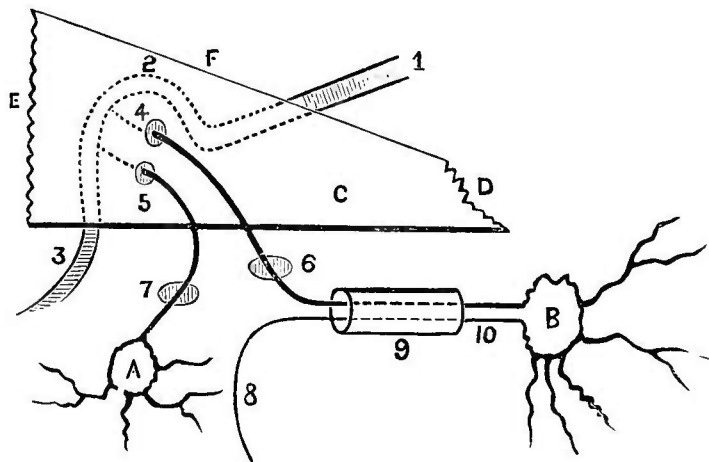

FIG. 65.—A diagram to show the course of the large and small petrosal nerves and the Vidian nerves.

A, *otic ganglion*; B, *Meckel's ganglion*; C, *petrous portion* of the temporal bone (its apex corresponding to the carotid canal at the base of the skull); D, *petrous portion* of the temporal bone (its base corresponding to the external auditory meatus); E, *petrous portion* of the temporal bone (its superior border, separating the middle and posterior fossæ of the skull); F, *petrous portion* of the temporal bone (its superior border, separating the middle and posterior fossæ of the skull); 1, the *facial nerve* entering the petrous portion of the temporal bone by means of the "*meatus auditorius internus*"; 2, the *facial nerve* following the curve of the "*aqueeduct of Fallopius*"; 3, the *facial nerve* escaping from the temporal bone by means of the "*stylo-mastoid foramen*"; 4, the *large petrosal nerve*, escaping into the cavity of the cranium by means of the "*hiatus Fallopii*"; 5, the *small petrosal nerve*, escaping into the cavity of the cranium by a foramen of its own; 6, the "*foramen basis cranii*," affording passage for the large petrosal nerve out of the cranium; 7, the "*foramen ovale*," affording passage for the small petrosal nerve out of the cranium, and thus to the *otic ganglion*; 8, a filament from the *carotid plexus* of the sympathetic nerve, joining the *large petrosal nerve* to form the *Vidian nerve*; 9, the *Vidian canal*, transmitting the *Vidian nerve* to *Meckel's ganglion*, B; 10, the *Vidian nerve*.

muscles is supplied by the same nerve as the muscles themselves.

The communication between the *facial nerve* and the

<sup>1</sup> The stapedius.    <sup>2</sup> Hilton, "Rest and Pain." See also page 12 of this volume.

*pneumogastric* might at first seem, to the casual reader, one of accident, rather than of design, on the part of the Creator; but, when we consider how intimately the *respiratory functions* and the *movements of the face* are associated with each other, the design at once becomes evident. Paralysis of the muscles which dilate the nostrils has been shown to have a marked effect upon respiration through the nostril; and, in the horse, which can only breathe through the nose, the effect of division of both of the facial nerves is to produce death from suffocation, since the nostrils collapse. It was this synchronism between the movements of the nostrils and the respiratory act that first led Sir Charles Bell<sup>1</sup> to regard the facial nerve as the one which presided over the function of respiration, and is still often called one of the "*respiratory nerves of Bell*."

A case is reported by this famous investigator where a patient, afflicted with unilateral facial paralysis, was obliged to lie upon the sound side, and to hold the paralyzed nostril open with the fingers, in order to breathe with comfort.<sup>2</sup>

The distribution of the facial nerve to the *muscles of the nose* creates an impairment of the *sense of smell*,<sup>3</sup> when that nerve is injured, since the free entrance of air is interfered with. The act of *sniffing*, which requires for its complete performance a dilated nostril, is rendered almost if not quite impossible, and thus a contact of odoriferous substances with the mucous membrane of the upper nasal chambers is mechanically interfered with, and acute perception of smell embarrassed.

#### BRANCHES OF DISTRIBUTION OF THE FACIAL NERVE.

The motor branches of the facial to the *muscles of the ear* are of more importance in animals than in man, since the ear in the animal becomes capable of perceiving sound with acuteness only by a change in its relative position to the head.

The *stylo-hyoid* and the *posterior belly of the digastric* muscles exhibit again the influence of the facial nerve upon

<sup>1</sup> "Lectures on the Nerves."

<sup>2</sup> *Op. cit.*

<sup>3</sup> A. Flint, Jr., *op. cit.*

the act of deglutition ; and the same remark will apply to the *stylo-glossus* muscle.

When the facial nerve has passed through the parotid gland, the two branches distributed to the face, viz., the *temporo-facial* and the *cervico-facial*, become not only motor in their function, but are also supplied with sensory filaments from their communication with other nerves ; so that some of their terminal filaments are distributed to the integument of the face, as well as those derived from the *fifth cranial nerve*, which would not be the case were the nerve not so supplied with sensory nerve fibers.

The filament of the facial nerve which supplies the *platysma muscle* affords a beautiful example of the fact that the nervous supply of the general muscular system, if carefully studied, constantly teaches us points of great physiological value as to the function of individual muscles, since, in the expression of *melancholy*,<sup>1</sup> and in the typical countenance of *thoracic* and *abdominal* diseases,<sup>2</sup> the platysma muscle plays a most important part, and is therefore supplied by the nerve of expression.

Again, the muscles of the *region of the mouth* are important agents in the prehension of food (especially so in animals, who often can not eat when the lips are paralyzed), and should properly be, in some way, connected with the muscles of mastication (chiefly supplied by the fifth nerve), and those of deglutition (supplied by the facial and the glosso-pharyngeal nerves) ; hence, the facial nerve is afforded communicating branches with both the *fifth* and the *glosso-pharyngeal* nerves.

One of the muscles of the face, the *buccinator*, which is supplied exclusively by the facial nerve, plays a most important part in *mastication* as well as in expression ; hence, when the facial nerve is paralyzed, the cheek can no longer force the food between the teeth, and a tendency toward accumulation of food within the cheek of the affected side becomes so

<sup>1</sup> Carpenter, *op. cit.*

<sup>2</sup> Sir Charles Bell, "Anatomy of Expression." See, also, article by the author, "The Human Face; its Modifications in Health and Disease, etc.," "New York Med. Jour.," September, 1880.



distressing to the patient that the fingers are frequently employed, during attempts at mastication of the bolus, to force the food between the jaws by pressure upon the external portion of the face.<sup>1</sup>

The value of this muscle in *expression* is made manifest in those acts where the cheek is either inflated with air, or where it is drawn inward, thus indicating the states of emaciation or extreme hunger. Much of the success of a comedian often depends upon the control which he possesses over the buccinator muscle. When the *facial nerve* upon *both sides* is paralyzed, mastication is almost as much impaired (on account of the buccinator muscles) as if the *inferior maxillary nerve* was destroyed.

The flaccidity of the buccinator muscle in "Bell's paralysis" accounts for the peculiar *puffing movement* of the cheek which accompanies each act of *expiration*, giving to the face an appearance similar to that noticed when *puffing* of a pipe is attempted; while, in those rare cases where the facial nerve is paralyzed upon both sides, the face assumes a condition which is remarkable for the entire absence of expression, and which can only be compared to the effect of covering it with a mask.

Many of the muscles of the face are of value as *guides in diagnosis*, since, in certain types of disease, some parts of the face are more affected than others.<sup>2</sup> This subject, however, is too complicated to be hastily reviewed, and it has sufficient value to merit its special consideration.

It may be perceived, by reference to the diagrammatic representation of the branches of the facial nerve, that the *temporo-facial* branch animates all of the muscles of the upper part of the face, while the *cervico-facial* branch supplies the lower region of the face and portions of the neck.<sup>3</sup> This explains why, after the *temporo-facial* branch has been divided,

<sup>1</sup> A. Flint, Jr., *op. cit.*

<sup>2</sup> See article by the author on "The Human Face; its Modifications in Health and Disease, and its Value as a Guide in Diagnosis:" "New York Med. Jour.," December, 1880.

<sup>3</sup> See page 179 of this volume.

as has occurred in operations upon the cheek, the *eye stands wide open* even during sleep; the *lower lid becomes everted* from traction of the parts below, and also from the effect of gravity; the occipito-frontalis and corrugator supercillii can no longer make either transverse or perpendicular wrinkles upon the forehead; and the upper portion of the face is abnormally smooth and passive, while the lower portion preserves all its normal power of movement.

Should the *cervico-facial* branch become alone impaired, the power of prehension of food by the lips is arrested, the action of the buccinator in mastication is stopped, and that process is proportionately interfered with; the *digastric* and *stylo-hyoid muscles* are, however, not paralyzed, since the special branches to those muscles are given off above the origin of this branch, and thus deglutition is not embarrassed.

#### CLINICAL POINTS AFFORDED BY THE FACIAL NERVE.

The diseases which affect the facial nerve may produce the different varieties of *facial spasm* and *paralysis*; the former being the result of some lesion which creates simply irritation, while the latter indicates some existing pressure or degeneration, which impedes the free action of the nerve.

#### SPASM OF THE MUSCLES OF THE FACE.

In a class of cases, by no means infrequent, facial spasm is perceived, to a greater or less degree, as the result of some cause of irritation to the nerve filaments of the trunk of the facial nerve, or to some of its branches. These mimic spasms, or "convulsive tic," are dependent upon an hereditary tendency, in some instances; since reported cases exist where the second generation, and even the third, has manifested the symptoms of facial spasm. We also meet this condition as an accompaniment of epilepsy, eclampsia, hysteria, tetanus, and chorea; again, in certain mental diseases, where the brain or its investing membranes are affected; and, finally, we see it developed under extraordinary periods of excitement.

Cases are on record where simple exposure, wounds of the

face, and pressure upon the peripheral filaments of the facial nerve have resulted in facial spasm. Perhaps this condition is most frequently met with as an evidence of some *reflex act*, excited through some other cranial nerves; hence we find it associated with such causes of irritation as caries of the teeth, periostitis, inflammatory affections of the eyeball, lids, or conjunctiva. Remak reports a case where a diseased condition of the brachial plexus caused spasms to start in the hand and progress along the side of the neck to the face, again illustrating the reflex character of the disease.

It is such cases as these latter that often test the anatomical knowledge of the diagnostician, since a command of the various anastomoses of nerves often enables the skilled anatomist to detect the seat of irritation far from the apparent seat of disease, and thus to obviate a distressing condition by some simple medicinal or surgical remedy.

The spasms of the facial muscles may assume either the *tonic* or *clonic* character. The former variety is observed in such conditions as tetanus, the late rigidity of paralyzed muscles, and the irritation following upon severe exposure and too intense faradization; while the latter are the most common, and result in those convulsive twitchings of the forehead, eyes, eyelids, nose, mouth, cheeks, and tongue, which produce the most extreme and often ludicrous distortion of the features. I have known such clonic spasms of the face to be produced by the irritation of worms in the intestine in children, and, in one case, to follow uterine disease in an adult. A peculiarity of these spasms is, that certain muscles seem to contract in a regular sequence or rhythm, and that, although the contraction may be prolonged and severe, no fatigue is usually complained of by the patient.

#### PARALYSIS OF THE MUSCLES OF THE FACE.

The general appearance of a sufferer from a well-marked attack of "Bell's paralysis" has already been depicted in a cut,<sup>1</sup> and described in the preceding text, under the effects

<sup>1</sup> See page 181 of this volume.

of section of the facial nerve; but many points of practical value pertain to this condition which have not as yet been mentioned, and which help greatly in making a diagnosis as to the exciting cause and the seat of the existing lesion. The symptoms produced by any impairment to the free action of the facial nerve vary to a marked extent with the degree of the paralysis, and the individual branches which may be involved; and distinctions between the various forms of facial paralysis, met with in a large clinical field, have been developed, by the investigations of Romberg, from those general propositions first advanced by Bell.

In studying the types of facial paralysis, we may start with advantage by reviewing the different groups which are clinically recognized. These may be enumerated as the *intra-cranial*; the *auditory* (where the existing lesion is confined to the interior parts of the temporal bone); the *rheumatic*; the *traumatic*; the *syphilitic*; and, finally, the *diphtheritic* form. We may also have the paralysis confined to one side of the face, the *unilateral*, or, affecting both sides of the face, the *bilateral*, or *facial diplegia*.

In the *intra-cranial* form of facial paralysis, the lesion of the brain is usually confined either to the base, or to the pons Varolii. If the pons Varolii is affected, the facial nerve will not be alone involved, as a rule, but a partial or complete hemiplegia will usually exist, which will be on the same side of the body as the facial paralysis, provided the upper (anterior) half of the pons is the seat of disease, but on the side opposite to the facial paralysis (crossed paralysis<sup>1</sup>), if the lower (posterior) part of the pons is affected. There is, perhaps, no point in the anatomy of the encephalon which is of more certain value to the diagnostician than the fact, first pointed out by Gubler, that a line drawn transversely across the pons Varolii at the points of escape of the trigemini marked the spot of probable decussation of fibers of the facial nerve; so that, if a lesion be anterior to this line, the facial

<sup>1</sup> For definition of this term and the various types met with, see page 59 of this volume.

paralysis will correspond to the hemiplegia, but, if behind that line, the condition of "crossed paralysis" of the facial and body type will be produced. A point of some diagnostic value in the detection of intra-cranial lesions, by means of the facial nerve, is afforded by the degree of the facial paralysis, since it is usually complete if caused by lesions of the pons Varolii or by the pressure of tumors of the base of the cerebrum.

The *second form* of facial paralysis, viz., that dependent upon some *abnormal condition within the temporal bone*, is liable to follow suppuration or hæmorrhage within the aqueduct of Fallopius; scrofulous caries of the temporal bone; local degeneration of the nerve within the aqueduct of Fallopius; local pressure upon the nerve from tumors, etc.; and traumatism of all kinds, of sufficient intensity to injure the deeper parts or to directly involve the nerve itself.

If you will recall the anatomy of the facial nerve within the aqueduct of Fallopius, and the branches which are given off in that canal, you will be better able to appreciate the points afforded by this anatomical knowledge in the diagnosis of the seat of a lesion which is causing facial paralysis. We have already, in connection with the effects of section of the facial nerve, mentioned the facial deformity which ensues; and the same description will answer for the effects of disease of the nerve, or pressure upon it, after it has escaped from the stylo-mastoid foramen. But the symptoms to which I now propose to call your attention are not included in that description, since they are due to branches which are given off by the facial nerve before it escapes from the temporal bone; although the same facial deformity, and all the evidences of impairment of the nerve on the distal side of the stylo-mastoid foramen, will, of necessity, be also present.

If the lesion be situated above the point of origin of the chorda tympani, but on the distal side of the petrosal nerves, the *sense of taste* will probably be affected on the correspond-

ing side of the anterior two thirds of the tongue ;<sup>1</sup> but the sense of taste is not, as a rule, abolished, although it is greatly diminished in acuteness. How this nerve affects the sense of taste, and the various experiments which have been recorded concerning it, will be found by reference to preceding pages.<sup>2</sup>

If the lesion of the facial nerve be situated behind the ganglionic enlargement from which the three petrosal nerves arise, the patient will reveal a depression of the *arch of the palate* upon the affected side ; thus, it will be seen to hang lower than the healthy side, and to approach a straight line along its free edge, rather than that of a marked curve, as in health. This is due to the paralysis of the levator palati muscle, which is supplied with motor power from Meckel's ganglion, through the large petrosal nerve. In addition to this deformity, the *soft palate is drawn toward the unaffected side* by the tensor tympani muscle, since the same muscle of the paralyzed side is no longer capable of acting, as it is supplied by the small petrosal nerve. The distribution of the small petrosal nerve to the otic ganglion still further explains why, in this type of cases, the *secretion of the parotid gland* of the affected side is diminished ; while the intimate association of the chorda tympani nerve with the *submaxillary gland* accounts for deficient secretion from that source.

It has been observed that the *sense of hearing becomes excessively acute*, when the facial nerve is affected on the proximal side of the point of origin of the petrosal nerves. This may possibly be due to the paralysis of the tensor tympani muscle, as suggested by Landouzy, since that muscle is supplied with motor power by a filament derived from the otic ganglion ; although the investigations of Brown-Séquard seem to point to a vaso-motor spasm of the internal ear, resulting in a condition of hyperæsthesia of the acoustic nerve.

The third form of facial paralysis occurs in connection

<sup>1</sup> The reader is referred to those pages in which the gustatory branch of the fifth nerve is discussed, since authorities differ as to the value and interpretation of this symptom.

<sup>2</sup> See page 160 of this volume.

with the *rheumatic diathesis*. It is well known that the influence of cold, which is particularly liable to favor rheumatic manifestations, is more keenly felt in the region of the cheek and eyelids, as shown by Weber; and the experiments of Wachsmuth,<sup>1</sup> upon the effect of cold upon the vaso-motor fibers in the region of the stylo-mastoid foramen, also point to the retardation, or, possibly, the entire suppression, of the blood supply to the facial nerve, as the explanation of this type of paralysis. A mild form of periostitis in the bony canals, through which the different branches of the facial nerve pass, may also occur in the rheumatic type as an exciting cause.

The *traumatic types* of facial paralysis may involve the entire nerve or only individual branches. Its symptoms, therefore, somewhat depend upon the situation and extent of the injury. It has been known to follow severe contusions of the face, cheek, or neck, incisions made by the surgeon, saber cuts and gunshot wounds, the compression exerted by the forceps during delivery, the pressure of growing tumors, supuration within the parotid gland or lymphatics of that region, and the pressure caused by extensive or deep cicatrices. This type of paralysis is often extremely obstinate and of long duration, and may be permanent; since the nerve may have undergone changes in its structure or the muscles may have become impaired.

In *sypphilis*, facial paralysis is sometimes developed. It may thus indicate the formation of intra-cranial tumors or meningeal exudations, which either press upon the nerve trunk or interfere with its fibers of origin. It may also be an evidence of extra-cranial lesions, such as periostitis of the mastoid region, tumors of the facial or cranial bones, or supuration dependent upon caries or necrosis of the temporal bone (if the entire nerve be affected), or of some of the facial bones, if individual branches only show evidences of pressure.

Cases are on record where the symptoms of facial paralysis have followed an attack of *diphtheria*. This is but one of

<sup>1</sup> As quoted by Rosenthal.

the various forms of paralysis which are frequently observed as sequelæ of this peculiar blood poison.

It may be well to hastily review the principal complications which are most frequently observed in connection with facial paralysis. These have a special importance to the scientific practitioner in enabling him to diagnose, not only the condition of the patient, but also the seat of the existing lesion.

We have considered the effects of lesions within the aqueduct of Fallopius. These may create (in addition to those of the facial muscles) symptoms referable to the impairment of the chorda tympani nerve (see page 193), of the petrosal nerves (see page 194), acoustic manifestations, or an effect upon the salivary secretions.

Intra-cranial lesions usually cause destruction of the motor power of the entire nerve, and, therefore, of all of its branches; hence, we are liable to have all of the previous symptoms present, as well as those of facial deformity.

Special branches of the nerve may be individually paralyzed, and thus produce symptoms referable only to those parts in which the motor power is deficient. The anatomy of the separate branches, as shown in the cuts on previous pages, will help you to understand the special symptoms which an impairment of any one branch would produce.

The condition of *bilateral facial paralysis*, or "*facial diplegia*," is a rare form of disease. It implies some form of pressure or degeneration, which shall affect the nerve of each side simultaneously; hence it may accompany a lesion situated in the anterior half of the pons, which crosses the median line; an exostosis of the interior surface of the basilar process of the occipital bone; an intra-cranial aneurism; and the presence of excessive meningeal exudation at the base of the brain. It sometimes accompanies the condition of labio-glosso-pharyngeal paralysis (Duchenne's disease), provided the lesion extends so as to involve the nuclei of origin of the facial nerves; and is occasionally met with in the course of certain chronic cerebral diseases. Jaccoud claims that the spontaneous atro-



phy of both facial nerves can occur without an exciting cause of a local character being detected ; and the same opinion is maintained by Pierreson,<sup>1</sup> who found a hyperplasia of the connective tissue of the nerve and the development of amyloid corpuscles to constitute the pathological changes.

This type of paralysis may be due to peripheral causes, such as exposure to intense cold, as in sleigh-riding, rheumatic inflammation of the nerves, and diseases of the petrous portion of the temporal bones (necrosis, caries, syphilitic otitis, suppurative inflammation of the middle ear, etc.).

The experiments of Schiff upon animals in whom both facial nerves had been divided, and the investigations of Trousseau, Wachsmuth,<sup>2</sup> and Davaine, have helped to clear up the effects of this double lesion, and to render its diagnosis from Duchenne's disease more positive than our previous knowledge would permit. In the human race, this condition is characterized by the following symptoms: a fixed and immovable countenance, a peculiar drooping of the angles of the mouth, a collapsed appearance of the nostrils during inspiration, a sinking inward of the cheeks during the inspiratory effort, and a protrusion or inflation of the cheek when the air is expired. The tone of the voice becomes of the most distinctly nasal quality, and the patient, from the inability to pronounce the labial consonants, is almost unable to make the simplest sentences intelligible. In consequence of paralysis of the buccinator muscles, which are supplied by the facial nerves, the act of mastication becomes embarrassed, and deglutition is greatly interfered with; hence it is not uncommon to see such patients use the finger to push the food into the grasp of the isthmus of the fauces, so as to swallow the bolus. When the head is inclined forward, the saliva runs from the mouth, in spite of all efforts to prevent it. The condition of the eyes,<sup>3</sup> which remain wide open on account of the

<sup>1</sup> As quoted by Rosenthal.

<sup>2</sup> As quoted by Hammond.

<sup>3</sup> In both the unilateral and bilateral forms of facial paralysis, the patient often can avoid the irritation of dirt and the intense light by closing the eyelids with the pressure of the finger, or by a strip of adhesive plaster.

paralysis of the orbicularis palpebrarum muscles, affords a most important point in the discrimination between this disease and the paralysis of Duchenne. So marked is this deformity that the patient can not wink, and thus the tears are not distributed over the globe of the eye, to wash off any dust which may enter; while, on account of the paralysis of the tensor tarsi muscle, the tears are not drawn into the lachrymal sac, and therefore tend to flow over the cheek and create scalding.

#### THE AUDITORY, OR EIGHTH NERVE.

This nerve is strictly one of *special sense*, namely, that of *hearing*. It arises from a *gray nucleus* in the floor of the fourth ventricle (where its fibers form the so-called “lineæ

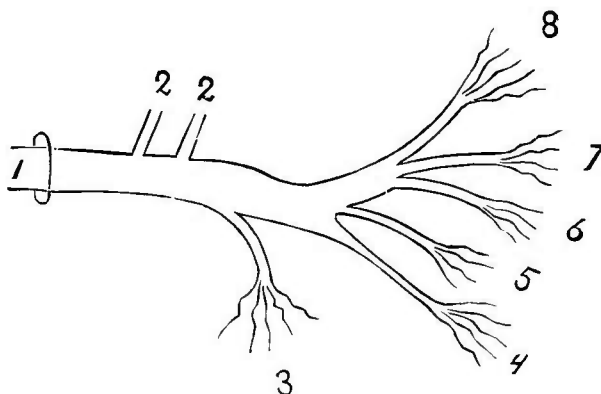

FIG. 66.—A diagram of the auditory nerve and its branches.

- 1, auditory nerve, entering the *meatus auditorius internus*; 2, communicating filaments to the *facial nerve*, given off in the *internal auditory canal*; 3, filaments given off to supply the *cochlea*; 4, filaments given off to supply the *posterior semicircular canal*; 5, filaments given off to supply the *sacculæ*; 6, filaments given off to supply the *utricle*; 7, filaments given off to supply the *external semicircular canal*; 8, filaments given off to supply the *ampullæ of the superior semicircular canal*.

transversæ” which decussate in the median line), and also, in part, from the *restiform body* of the medulla oblongata. It is claimed by Foville that its fibers may be also traced to the *flocculus* and the *gray matter of the cerebellum*, and, from recent statements of Lockhart Clarke, additional fibers may be traced from the auditory nucleus, which pass directly through the restiform body of the medulla.

The course of the nerve, as far as the orifice of the internal

auditory canal, lies parallel with that of the facial nerve, since the same arachnoid sheath invests them both, but, before that canal is reached, a filament is given off from both these nerves to form an intermediate nerve, called the “pars intermedia,” or the “nerve of Wrisberg.” This intermediate portion is now supposed to be the chief source of origin of the *chorda tympani nerve*, and thus to be connected with the special sense of taste.

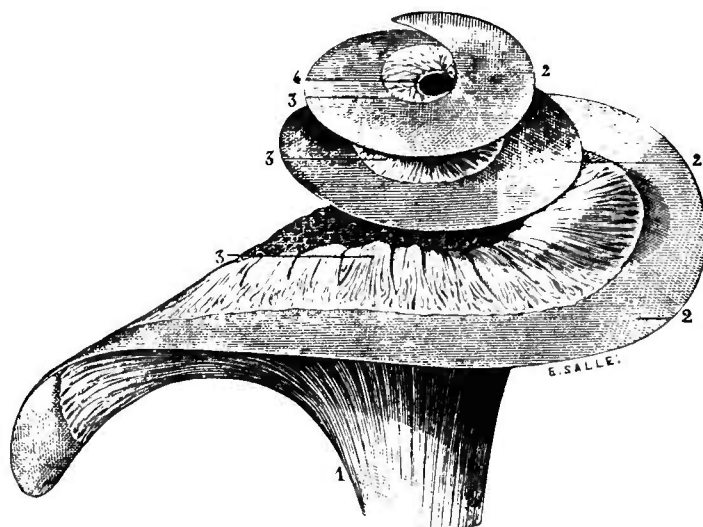

FIG. 67.—Distribution of the cochlear nerve in the spiral lamina of the cochlea (the cochlea is from the right side and is seen from its antero-inferior part). (Sappey.)

1, trunk of the cochlear nerve; 2, 2, 2, membranous zone of the spiral lamina; 3, 3, 3, terminal expansion of the cochlear nerve, exposed in its whole extent by the removal of the superior plate of the lamina spiralis; 4, orifice of communication of the scala tympani with the scala vestibuli.

The color of the auditory nerve filaments is grayish. The filaments differ from those of the other cerebro-spinal nerves (excepting those of special sense) in having a softer consistence. Some of the later researches seem to show that the filaments of this nerve are destitute of the “white substance of Schwann,” and thus resemble those of the olfactory nerve, while the *axis cylinders* are of very large size as compared with those of other nerves. It is also claimed that small, nucleated, *ganglionic enlargements* can be demonstrated along the course of these fibers of the trunk of the nerve, but the minute anatomy of the auditory nerve is yet a subject for further investigation.

Within the internal auditory canal, the eighth nerve

divides into two branches, the anterior of which supplies the cochlea, while the posterior branch is distributed to the *semicircular canals* and to the *sacculæ* and *vestibule*. These two main branches are given off close to the meatus auditorius internus.

At the bottom of the internal auditory canal, the three subdivisions of the vestibular nerve pass through *small open-*

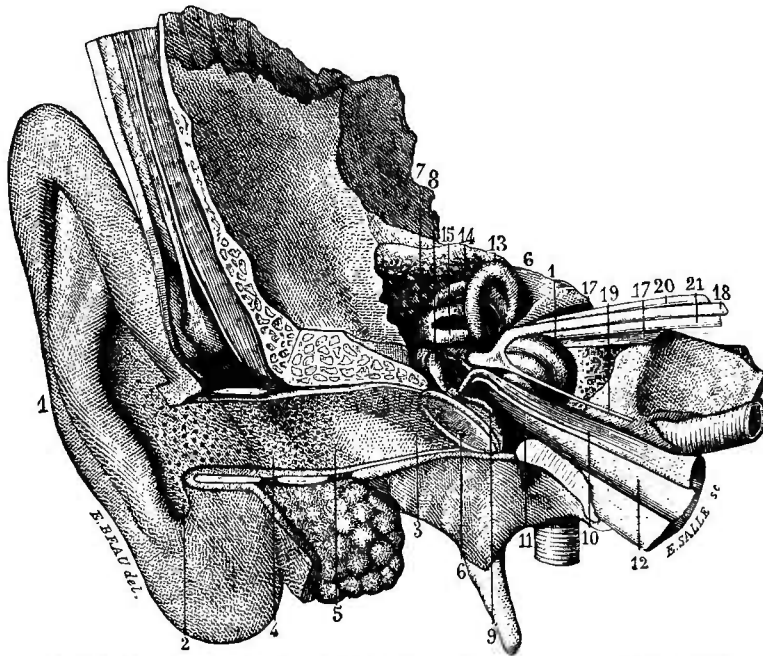

FIG. 68.—General view of the organ of hearing. (Sappey.)

1, pinna; 2, cavity of the concha, on the walls of which are seen the orifices of a great number of sebaceous glands; 3, external auditory meatus; 4, angular projection formed by the union of the anterior portion of the concha with the posterior wall of the auditory canal; 5, openings of the ceruminous glands, the most internal of which form a curved line, which corresponds with the beginning of the osseous portion of the external meatus; 6, membrana tympani and the elastic fibrous membrane which forms its border; 7, anterior portion of the incus; 8, malleus; 9, handle of the malleus applied to the internal surface of the membrana tympani, which it draws inward toward the projection of the promontory; 10, tensor tympani muscle, the tendon of which is reflected at a right angle to become attached to the superior portion of the handle of the malleus; 11, tympanic cavity; 12, Eustachian tube, the internal or pharyngeal extremity of which has been removed by a section perpendicular to its curve; 13, superior semicircular canal; 14, posterior semicircular canal; 15, external semicircular canal; 16, cochlea; 17, internal auditory canal; 18, facial nerve; 19, large petrosal branch, given off from the ganglioform enlargement of the facial and passing below the cochlea to go to its distribution; 20, vestibular branch of the auditory nerve; 21, cochlear branch of the auditory nerve.

*ings* in a cul-de-sac situated at that point, and are distributed to the utricle, the sacculæ, and the three ampullæ.

The cochlear nerve, which is the other main branch of the auditory, enters the *base of the modiolus*, and its filaments

subsequently escape from the central canal of the modiolus through *minute canals*, which enable them to reach their point of distribution in the internal portion of the cochlea. The terminal filaments of this nerve are now believed to be connected with the *spindle-shaped cells* of the *organ of Corti*.

It is impossible, within the compass of this lecture, to enter into the minute anatomy of the ear with sufficient detail to enable you to properly appreciate the mechanism by which the waves of sounds, produced from without, are transmitted to the *membrana tympani*, and subsequently to the cochlea, where they are perceived by the auditory nerve filaments. To properly appreciate the difficulties which arise in determining the exact method by which the human ear is enabled to determine not only the *intensity* of the sound perceived, but also its *pitch*, *quality*, and *musical properties*, not only would the anatomy have to be given in detail, but many of the laws of physics discussed. The following general statements, however, may assist you in studying this complicated subject, and afford an explanation of some of those symptoms of disease which are referred to the ear.

The diagram shown you on the blackboard<sup>1</sup> is designed to assist you to grasp some of the principal points in the anatomical construction of the ear, which are necessary for the clear comprehension of the physiology of audition. It can be perceived that the external auditory canal and its accessory portion which we call the ear or auricle (which is placed on the exterior of the skull for the purpose of deflecting the waves of sound into that canal) lie external to the *membrana tympani*; and, for that reason, all of these parts, viz., the cartilages of the pinna, its ligaments, the bony canal leading to the *membrana tympani*, and its cutaneous lining, are included under the general term “the *external ear*,” in contrast to the chambers which lie deeply within the temporal bone, called the *middle ear*, or “the *cavity of the tympanum*,” and the *internal ear*, or the “*labyrinth*.”

The *middle ear*, or “*tympanum*,” lies between the mem-

<sup>1</sup> See diagram further on in the chapter.

brana tympani and the internal ear, or "labyrinth," and is contained within the petrous portion of the temporal bone. It communicates with the pharynx, by means of the Eusta-

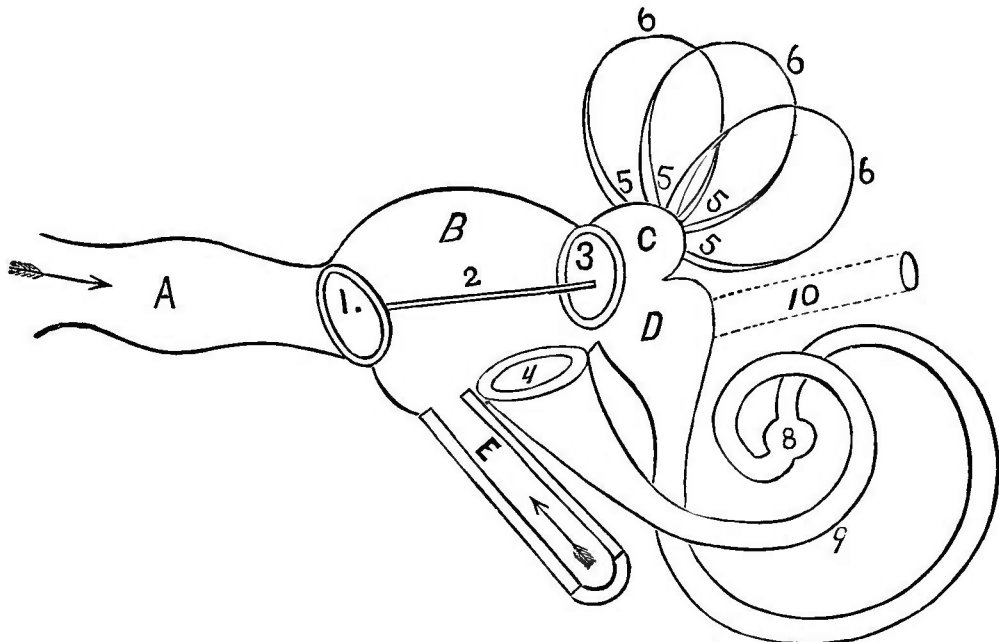

FIG. 69.—A diagram to illustrate the mechanism of the act of hearing.

A, the auditory canal (the arrow showing the waves of sound entering); B, the cavity of the middle ear, or "tympanum"; C, the utricle, communicating with the semicircular canals; D, the saccule, communicating with the scala vestibuli of the cavity of the cochlea; E, the Eustachian tube, allowing of the entrance of air into the middle ear from the pharynx; 1, the membrana tympani, which first receives the vibrations of the waves of sound; 2, the chain of bones, which transmit these vibrations to the membrane covering the fenestra ovalis (annular ligament of the stapes); 3, the membrane, covering the fenestra ovalis (annular ligament of the stapes); 4, the foramen rotundum, where the waves of sound return to the cavity of the middle ear and are lost (membrana tympani secundaria); 5, the ampullæ of the semicircular canals; 6, the semicircular canals; 7, the "scala vestibuli" of the cochlea; 8, the cupola, at the apex of the cochlea, where the scala vestibuli and the scala tympani of the cochlea join each other; 9, the "scala tympani," leading downward from the cupola of the cochlea to the foramen rotundum; 10, internal auditory canal, where the auditory nerve enters.

chian tube, and is thus enabled to afford free access to the air of the external world, and insure the same density of atmosphere on both sides of the membrana tympani. It is this anatomical arrangement that causes gunners to hold the mouth wide open when exploding large pieces of ordnance, to avoid a rupture of the membrana tympani, since the waves of sound can thus enter the Eustachian tube at the same time that they pass down the external auditory canal, and the membrana tympani should, theoretically, be made to stand

motionless, if the Eustachian tube were wide open, since the waves of sound upon each side of the membrane would neutralize each other.<sup>1</sup> In the cavity of the middle ear, a *chain of small bones* is so arranged as to afford a source of transmission of the impulses of sound from the membrana tympani to the fenestra ovalis,<sup>2</sup> which is closed by the stapes<sup>3</sup>

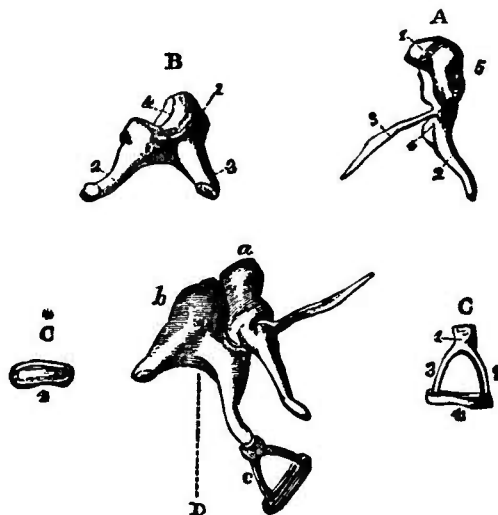

FIG. 70.—Ossicles of the tympanum of the right side, magnified 4 diameters. (Arnold.)

A, malleus; 1, its head; 2, the handle; 3, long, or slender process; 4, short process; B, incus; 1, its body; 2, the long process with the orbicular process; 3, short, or posterior process; 4, articular surface receiving the head of the malleus; C, stapes; 1, head; 2, posterior crus; 3, anterior crus; 4, base; C\*, base of the stapes; D, the three bones in their natural connection as seen from the outside; a, malleus; b, incus; c, stapes.

and its annular ligament. This chain of bones is *suspended* by a ligament attached to the roof of the middle ear, and the separate bones are connected together by joints<sup>4</sup> lined with synovial membranes, so that the slightest movement is readily carried from one to the other. Muscles are also attached to these bones, for the object of bringing the mem-

<sup>1</sup> Valsalva's method, "which consists of making a powerful expiration, with the mouth and nostrils closed," is also used if the ear be stopped with cotton at the same time.

<sup>2</sup> A doctrine first suggested in 1851 by Edward Weber, and subsequently verified by experiments in 1868 by Politzer.

<sup>3</sup> One of the small bones of the middle ear.

<sup>4</sup> Helmholtz first described the exact nature of the joint between the malleus and the incus. He compared it to "a joint used in certain watch-keys, where the handle can not be turned in one direction without carrying the steel shell with it, while in the other direction it meets with only a slight resistance." This device assists to convert the bones into a state of resistance, resembling that of a solid piece of bone, when muscular action locks this joint firmly.

brana tympani and the bones themselves into the best possible condition for the *accurate appreciation* of sound impulses.<sup>1</sup> The cavity of the middle ear is in communication with the cells in the mastoid portion of the temporal bone, and some additional effect may be thus produced upon the vibrations of the air within the middle ear.<sup>2</sup>



FIG. 71.—The left bony labyrinth of a new-born child, forward and outward view. Modified from a photograph. (Rüdinger.)

1, the wide canal, the beginning of the spiral canal of the cochlea; 2, the fenestra rotunda; 3, the second turn of the cochlea; 4, the final half turn of the cochlea; 5, the border of the bony wall of the vestibule, situated between the cochlea and the semicircular canals; 6, the superior, or sagittal semicircular canal; 7, the portion of the superior semicircular canal bent outward; 8, the posterior, or transverse semicircular canal; 9, the portion of the posterior connected with the superior semicircular canal; 10, point of junction of the superior and the posterior semicircular canal; 11, the ampulla ossea externa; 12, the horizontal, or external semicircular canal.

The *internal ear*, or "*labyrinth*," lies within the petrous portion of the temporal bone, and internal to the tympanum. It consists of a series of chambers, hollowed out within the bone, called the *vestibule*, the *cochlea*, and the *semicircular*

<sup>1</sup> The *tensor tympani* muscle, on account of a peculiar arrangement of the joint between the malleus and the incus, renders all the articulations firm, tightens the little ligatures, and presses the stapes against the fenestra ovalis, thus bringing it in contact with the fluids of the vestibule. See foot-note on page 203.

<sup>2</sup> For the surgical application of this arrangement, see article on the bones of the head, by the author, "New York Medical Record," October 16, 1880.



*canals*, within each of which a membranous tube is suspended between two liquids, one within the tube, the “endolymph,” and one between the tube and the bony walls, the “perilymph.” This membranous portion is called the “*mem-*

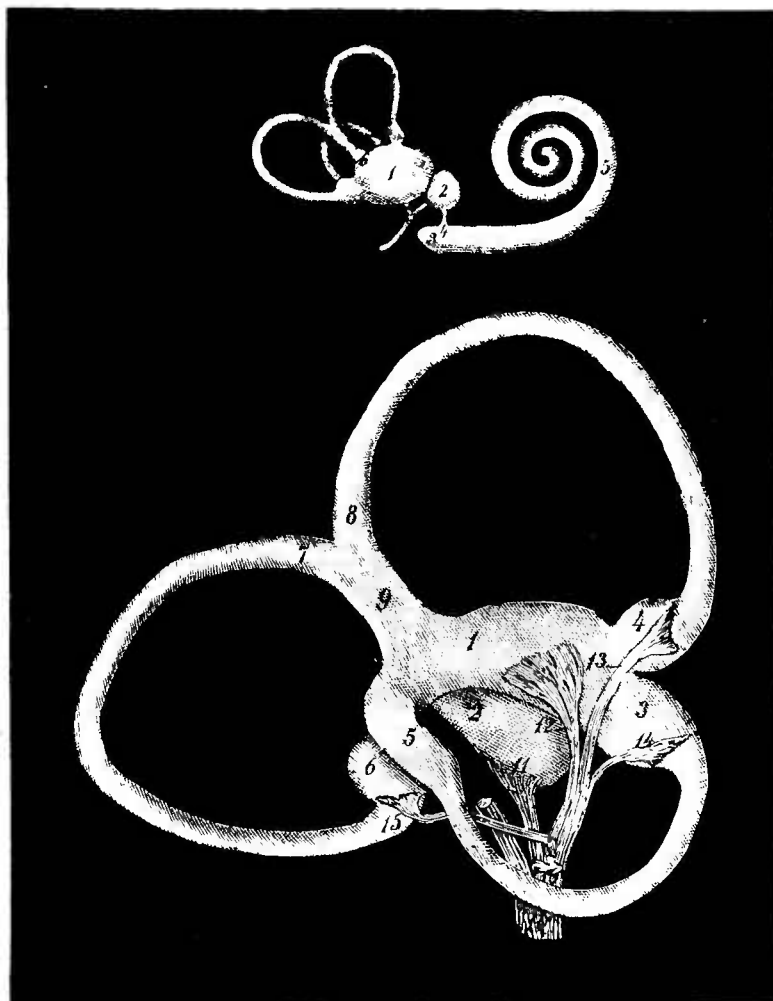

FIG. 72.—Diagram of the labyrinth, vestibule, and semicircular canals. From a photograph, and somewhat reduced. (Rüdinger.)

Upper figure: 1, utricle; 2, sacculæ; 3, 5, membranous cochlea; 4, canalis reuniens; 6, semicircular canals.

Lower figure: 1, utricle; 2, sacculæ; 3, 4, 6, ampullæ; 5, 7, 8, 9, semicircular canals; 10, auditory nerve (partly diagrammatic); 11, 12, 13, 14, 15, distribution of the branches of the nerve to the vestibule and the semicircular canals; 16, ganglioform enlargement.

*branous labyrinth*,” and is an exact reproduction of the bony labyrinth, except that it is smaller in point of size, so as to admit the presence of fluid between it and the bone. It serves as a *support for the terminal filaments* of the *auditory nerve*, which, by being suspended between two fluids, are en-

abled not only to perceive the slightest vibrations of the fluids,<sup>1</sup> but are also thus protected from the possibility of injury, which would be great were they placed in contact with the bone. The membranous labyrinth which fills the cavity of the vestibule is divided into two portions, called the *saccul*e and the *utricle*; the former of which communicates directly with the cochlea, while the latter communicates with the semicircular canals, as can be seen in the diagram.

The cochlea is essentially that part of the internal ear which is enabled to appreciate most of the important elements of sound, viz., its *note* and *quality*.<sup>2</sup> It consists of an exca-

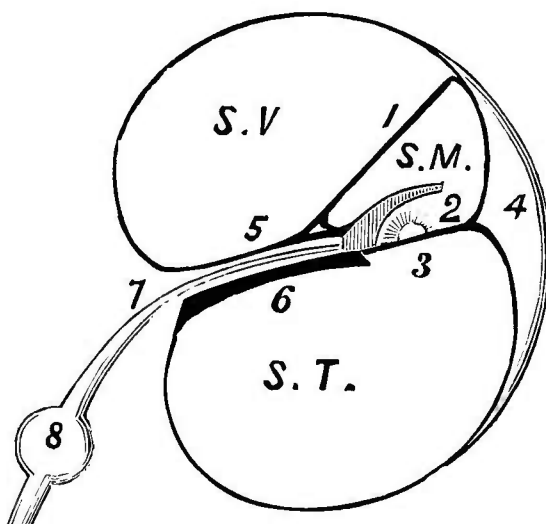

FIG. 73.—A transverse section of the spiral canal of the cochlea (diagrammatic).<sup>3</sup>

S. V., the *scala vestibuli*; S. M., the *scala media*; S. T., the *scala tympani*; 1, *membrane of Reissner*; 2, "*organ of Corti*," covered by the "*membrana tectoria*," or "*membrane of Corti*"; 3, *membrana basilaris*; 4, *ligamentum spirale*, extending the whole length of the spiral canal of the cochlea; 5, upper layer of the *lamina spiralis ossea*; 6, lower layer of the *lamina spiralis ossea*; 7, a nerve filament escaping from the *central canal of the modiolus*, and going to the *organ of Corti*; 8, a *ganglion* attached to the nerve filament, called the "*ganglion spirale*."

vation in the temporal bone which resembles, in its construction, the shell of a snail, having a central pillar, the *modiolus*, which runs from its base to its apex, and a *spiral canal*,

<sup>1</sup> It is a well-recognized law of physics that the fluids transmit vibrations in every direction with equal force, and, therefore, no better medium could possibly be had for the auditory nerve filaments to be in contact with.

<sup>2</sup> Complete destruction of the *cochlea* probably causes total deafness, while destruction of the *semicircular canals* does not seem to have any marked effect upon the ability to appreciate sound.

<sup>3</sup> From the "*Essentials of Anatomy*" (Darling and Ranney), New York, 1880.

running around this central portion for two and a half complete turns. The spiral canal of the cochlea is divided into three portions called the *scala vestibuli*, *scala tympani*, and the *scala media*.<sup>1</sup> The first communicates, at its lower part,

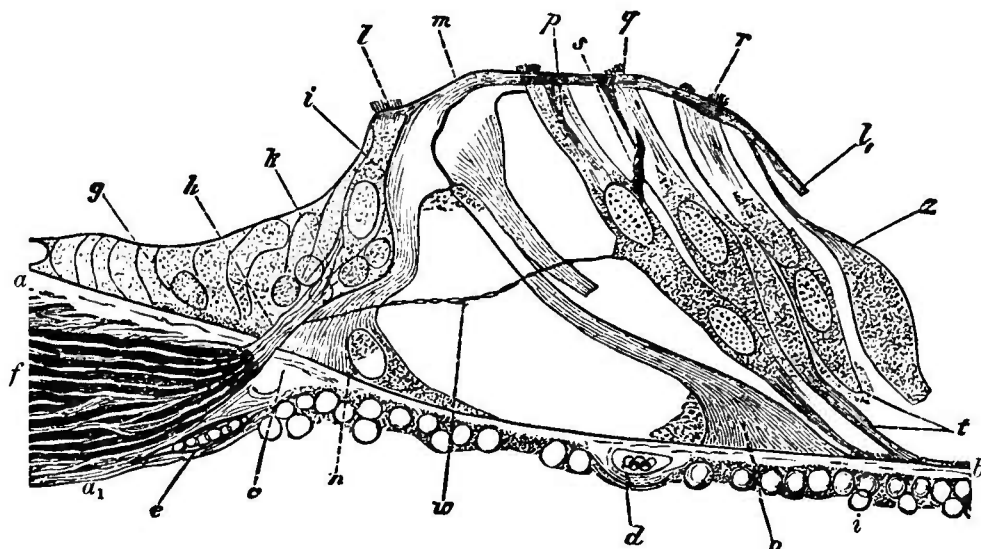

FIG. 74.—Vertical section of the organ of Corti of the dog, magnified 800 diameters. (Waldeyer.)

*a-b*, homogeneous layer of the basilar membrane; *v*, tympanic layer, with nuclei, granular cell protoplasm, and connective tissue; *a*<sub>1</sub>, tympanic lip of the crista spiralis; *c*, thickened portion of the basilar membrane; *d*, spiral vessel; *e*, blood-vessel; *f*, *h*, bundle of nerves; *g*, epithelium; *i*, inner hair cell, with its basilar process, *k*; *l*, head-plate of the inner pillar; *m*, union of the two pillars; *n*, base of the inner pillar; *o*, base of the outer pillar; *p*, *q*, *r*, outer hair cells, with traces of the cilia; *t*, bases of two other hair cells; *z*, Hensen's prop cell; *l-l*<sub>1</sub>, lamina reticularis; *w*, nerve fiber passing to the first hair cell, *p*.

with the vestibule; hence its name; the second terminates in the middle ear, and hence its name; while the third is, in

<sup>1</sup> The experiments of Laborde (Des fonctions du limaçon, "Trib. Méd.," Septembre 12, 1880) to determine the function of the cochlea were made upon the Guinea-pig, an animal in whom the organ is particularly accessible. The following facts were considered by him as fully proven: 1, Destruction of the cochlea had no effect in the production of vertigo or disturbances of coördination; 2, destruction of the cochlea produced complete deafness, which, however, did not appear until several days after the operation.

He concludes, from these facts: 1, That the auditory nerve contains both *motor* and *sensory* fibers, the former being distributed to the *semicircular canals*, the latter to the *sacculc*, *utricle*, and *cochlea*; 2, that the cochlea is not the only organ for the appreciation of sound, since the *utricle* and *sacculc* participate, to some unknown extent, in that function; 3, that the deafness which occurs after excision of the cochlea alone is probably due to an extension of inflammation to the utricle and sacculc, or to the formation of a rigid cicatrix, which prevents the transmission of an auditory impulse to those parts. While these facts need subsequent confirmation (since the experiments are by no means conclusive), they are worthy of due consideration in the discussion of this complicated and imperfectly understood organ.

reality, but a space partitioned off from the scala vestibuli for the protection of the true organ of hearing, "the organ of Corti." The preceding diagram (Fig. 73) will help to make this plain to you.

This figure represents, in a diagrammatic way, the appearance of a longitudinal section of the spiral cord in the cochlea, in any portion of its two and a half turns around the modiolus. It will be perceived at a glance that the canal is divided into an upper (*s. v.*) and a lower (*s. t.*) portion, partly by bone (5 and 6) and partly by membrane (3). It will also be readily seen that a portion of the scala vestibuli is divided off by the *membrane of Reissner*, and that thus a separate cavity is formed throughout the whole length of the spiral canal, called the "scala media." Within this last-named cavity will be noticed a body covered with hair-like processes, "the *organ of Corti*," which rests upon the membrane forming the floor of the scala media, and called for that reason the "*basilar*

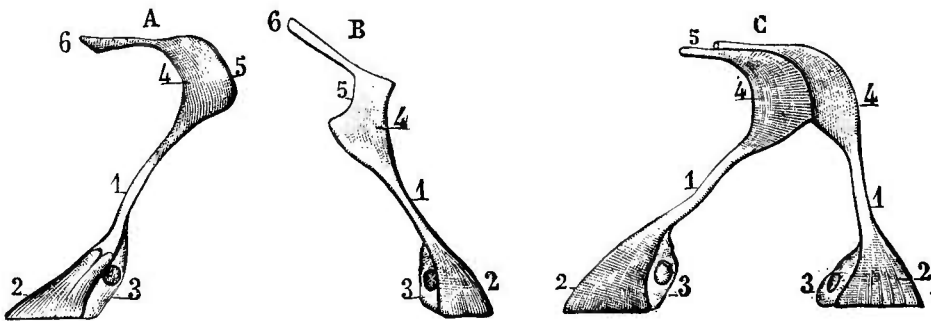

FIG. 75.—*The two pillars of the organ of Corti.* (Sappey.)

- A, external pillar of the organ of Corti: 1, body, or middle portion; 2, posterior extremity, or base; 3, cell on its internal side; 4, anterior extremity; 5, convex surface by which it is joined to the internal pillar; 6, prolongation of this extremity.
- B, internal pillar of the organ of Corti: 1, body, or middle portion; 2, posterior extremity; 3, cell on its external side; 4, anterior extremity; 5, concave surface by which it is joined to the external pillar; 6, prolongation, lying above the corresponding prolongation of the external pillar.
- C, the two pillars of the organ of Corti, united by their anterior extremity, and forming an arcade, the concavity of which looks outward: 1, 1, body, or middle portion of the pillars; 2, 2, posterior extremities; 3, 3, cells attached to the posterior extremities; 4, 4, anterior extremities joined together; 5, terminal prolongation of this extremity.

*membrane.*" There is, furthermore, shown in this figure the means by which the terminal filaments of the cochlear nerve (one of the branches of the auditory nerve) escape from the *central canal of the modiolus* and reach the scala media.

Such a figure will greatly assist you to properly appreciate the discussion of the function of each of these various parts, and also enable you to grasp the principal points in the physiology of the act of hearing, which are to be considered.

The *organ of Corti* may be compared to a harp, since its rods are of different lengths. It is a continuous structure for the entire course of the spiral canal of the cochlea. Helmholtz has advanced the theory<sup>1</sup> that the several thousand strings of this organ admit of the appreciation of all varieties of musical tone, since each note or chord creates a vibration

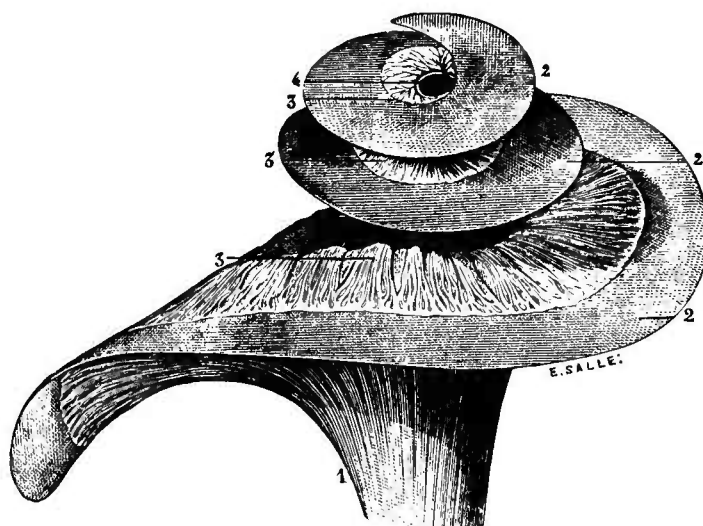

FIG. 76.—Distribution of the cochlear nerve in the spiral lamina of the cochlea (the cochlea is from the right side and is seen from its antero-inferior part). (Sappey.)

1, trunk of the cochlear nerve; 2, 2, 2, membranous zone of the spiral lamina; 3, 3, 3, terminal expansion of the cochlear nerve, exposed in its whole extent by the removal of the superior plate of the lamina spiralis; 4, orifice of communication of the scala tympani with the scala vestibuli.

in those strings only which are necessary to reproduce it, in the same way as a piano, when a note is sounded, will create a vibration in the same string of an adjoining instrument. Hensen, however, claims that the *basilar membrane* is composed of *elastic fibers of varying lengths*,<sup>2</sup> and that these separate fibers are thrown into vibration by sounds carried to the cochlea, which, in turn, transmit their vibration to the

<sup>1</sup> This theory is opposed by the facts that the rods of Corti are *not elastic*, and they are *absent in birds*, who can unquestionably perceive sound.

<sup>2</sup> By some authors this theory is attributed to Helmholtz.

organ of Corti lying upon them, and thus inform the auditory nerve filaments of the effect of each individual sound.<sup>1</sup>

In the act of hearing, the vibrations produced within the *membrana tympani* by the waves of sound are transmitted across the cavity of the middle ear, to a membrane covering an opening nearly opposite the external drum, called the *fenestra ovalis*, by means of a chain of small bones within the cavity of the middle ear, and, by means of secondary vibrations thus produced within this latter membrane, the impulse is transmitted to the *fluids of the vestibule*. The vibrations now travel along the fluids of the scala vestibuli of the cochlea and of the semicircular canals, thus passing in two different directions. In the semicircular canals, according to some observers, the *direction* from which the sound springs is perceived,<sup>2</sup> while the vibrations carried along the scala media<sup>3</sup> in the cochlea are transmitted to the filaments of the auditory nerve in the "organ of Corti," probably by means of vibrations of the *membrana basilaris*, thus affording the appreciation of the *note* and the *quality* of the sound perceived. After reaching the apex of the cochlea, the vibrations are transmitted from the scala vestibuli downward along the course of the scala tympani till they reach the "membrana tympani secundaria," which covers the *fenestra rotunda*,<sup>4</sup> where they are lost,<sup>5</sup> being no longer

<sup>1</sup> The *membrana tectoria*, or "membrane of Corti," probably acts as a damper, to arrest the vibrations excited within the scala media, as its situation suggests no other possible function.

<sup>2</sup> The function of the semicircular canals is yet a matter of doubt, and is now receiving the attention of experimental physiologists. They are supposed by some authors to relieve *excessive pressure* within the labyrinth when the stapes is driven too forcibly inward; and, by others, to *secrete the fluid of the labyrinth*; while by some they are considered to be the external organs of coördination of muscular movement.

<sup>3</sup> The saccule communicates with the scala media by means of a small canal (shown in Fig. 72), called the "canalis reuniens."

<sup>4</sup> An opening in the inner wall of the cavity of the middle ear.

<sup>5</sup> According to some authorities, the vibrations in the *membrana tympani secundaria* are created, simultaneously with those at the *fenestra ovalis*, by the vibrations of the air in the middle ear created by the movements of the external drum membrane, and an impulse thus travels simultaneously along the scala tympani and the scala vestibuli, both *going in the same direction*, to meet each other at the *cupola*. They consider the second drum, at the foramen rotundum, as a proof of this function, but it must be apparent to any one that all the openings of the labyrinth into the middle ear must be closed in some way

transmitted, on account of the absence of any conducting medium.

The free *entrance of air* to the cavity of the tympanum, or the middle ear, affords an equal density of air upon either side of the *membrana tympani*, and thus insures a vibration of that membrane in absolute unison with the vibrations of the sound which it is called upon to record, as the waves pass down the external auditory canal.

The function of the *organ of Corti*, of the *membrana basilaris*, or of the *otoliths*, can not be stated with any degree of certainty, since new discoveries are constantly being made, although some theories of their functions have been already given.

The minute construction of the *scala media* and its contained organs can be found by reference to more extensive treatises.

#### CLINICAL POINTS OF INTEREST DEPENDENT UPON THE AUDITORY NERVE.

In attacks of auditory vertigo, or Menière's disease, there is much more than ordinary giddiness. The patient will often

to prevent the *escape of the perilymph*. While it is difficult to positively decide this point, I am personally inclined to regard the foramen rotundum as the *seat of termination* of wave sounds, rather than a means of *transmission of impulses* to the fluids of the cochlea.

Dr. A. H. Buck, in a late treatise on the "Diagnosis and Treatment of Ear Diseases," again advocates theories long maintained by him as to the physiology of audition, which may be thus given: The impulse of the stapes, at the fenestra ovalis, is carried by means of the *perilymph* directly into the *scala vestibuli*. This causes compression of the fluid in the *scala media*, which, in turn, causes pressure upon and movement of the elastic "*membrana basilaris*." The pressure is thus transmitted, for a second time, to the fluid in the *scala tympani*, and, as fluids are incompressible, the *membrana tympani secundaria*, which closes the foramen rotundum, is forced *into the cavity* of the middle ear until the force is expended, when it returns to its normal condition. It will be thus perceived that he discards the *sacculæ* and the *canalis reuniens* as a channel for the passage of the acoustic wave. He also questions the existence of any communication, at the *cupola*, between the *scala vestibuli* and the *scala tympani*. While his theory seems ingenious, and perhaps more in accordance with fact than the older views, and is well illustrated by diagrams and supported by some carefully conducted experiments, still it can not, as yet, be said to be positively confirmed. His view as to the absurdity of the *membrana tympani secundaria* being a transmitter of sound waves to the cochlea agrees with my own, as advocated above. He seems also to favor the theory that the basilar membrane is the true *vibrating medium*, which carries to the auditory nerve the appreciation of the note sounded, rather than the "organ of Corti."

tell you that, when the attack commenced, everything began to whirl, or possibly appeared to be moving toward one side; that his gait became unsteady, and, if walking was possible, that he reeled and staggered; while, in some severe cases, the patient feels unsafe even when lying upon a bed or sofa, and may be obliged to grasp the sides of the couch to protect him-

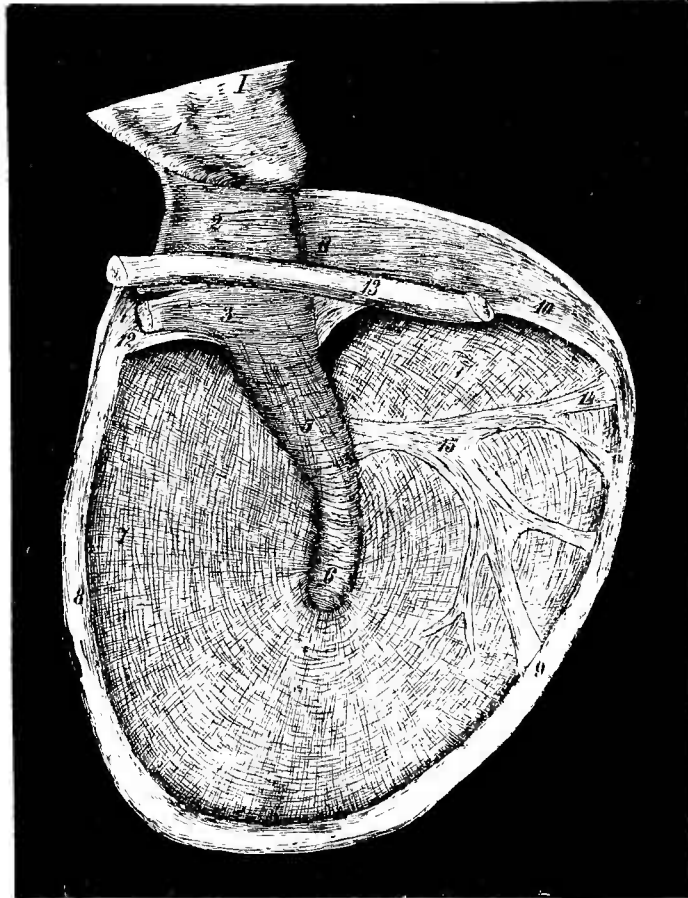

FIG. 77.—*Right membrana tympani, seen from within. From a photograph, and somewhat reduced. (Rüdinger.)*

1, head of the malleus, divided; 2, neck of the malleus; 3, handle of the malleus, with the tendon of the tensor tympani muscle; 4, divided tendon of the tensor tympani; 5, 6, portion of the malleus between the layers of the membrana tympani; 7, outer (radiating) and inner (circular) fibers of the membrana tympani; 8, fibrous ring of the membrana tympani; 9, 14, 15, dentated fibers, discovered by Gruber; 10, posterior pocket; 11, connection of the posterior pocket with the malleus; 12, anterior pocket; 13, chorda tympani nerve.

self from a sensation of falling. In many cases, these symptoms are markedly intensified *by movement of the head*, and, in some instances, such movements often tend to bring about an attack.<sup>1</sup> The patient is usually pale and haggard, some-

<sup>1</sup> Buzzard, "Lancet," March 4, 1876.



times perspires freely, and often vomits,<sup>1</sup> while *pain within the head* is a symptom which not infrequently accompanies such an attack. The extent to which this type of vertigo may be manifested varies from an attack of but momentary duration, where the patient can retain his feet, to those severe forms of the disease where the attack is accompanied by a loss of consciousness, which may remain for some hours, and resemble the condition of epileptic vertigo.

There seems to be little doubt that, in these cases, the attack is always preceded or followed by some abnormal condition of the ear, and that this diseased condition was the *starting point* of the vertigo.<sup>2</sup> Sometimes the patient has long been deaf in one ear, or a condition of deafness may follow the first attack of vertigo; again, the approach of an attack of vertigo may be told by the occurrence of *noises* within the ear of one side, while, in some cases, there exists a constant noise within the ear, which increases as the attack of vertigo is imminent.

It is often extremely difficult to persuade a patient, suffering from this affection, that the attack is not dependent upon a disordered state of the *digestive apparatus*, and especially is this the case when the ear trouble is of old standing, or when the patient is unconscious of any defect in his hearing, which is by no means an unusual occurrence. Such patients are better satisfied if the attack be attributed to the liver, dyspepsia, or nervousness. I quote the following sentence from Hughlings-Jackson<sup>3</sup> as evidence that this difficulty is met with even among the most enlightened of the community. He says: "Even medical men, who have aural disease, often totally reject the proffered explanation of their attacks of vertigo; many of them ascribe their ailment to digestive

<sup>1</sup> Ferrier, "Vomiting in connection with cerebral disease," "Brain," July, 1870.

<sup>2</sup> The occurrence of vertigo and interference with coördination is not alone produced by local disease of the ear, even when associated with impairment of hearing. It may indicate disease of the cerebellum or of the medulla oblongata, which creates irritation of or some interference with the auditory nucleus. For the clinical facts pertaining to this symptom, the reader is referred to pages 63 and 64 of this volume.

<sup>3</sup> Hughlings-Jackson, "Lancet," March 11, 1876; same author, "Lancet," March 11, 1876; Gowers, "Lancet," March, October, 1880.

troubles. A medical man had deafness in his left ear, with occasional slight vertigo. One day, while walking in his gar-

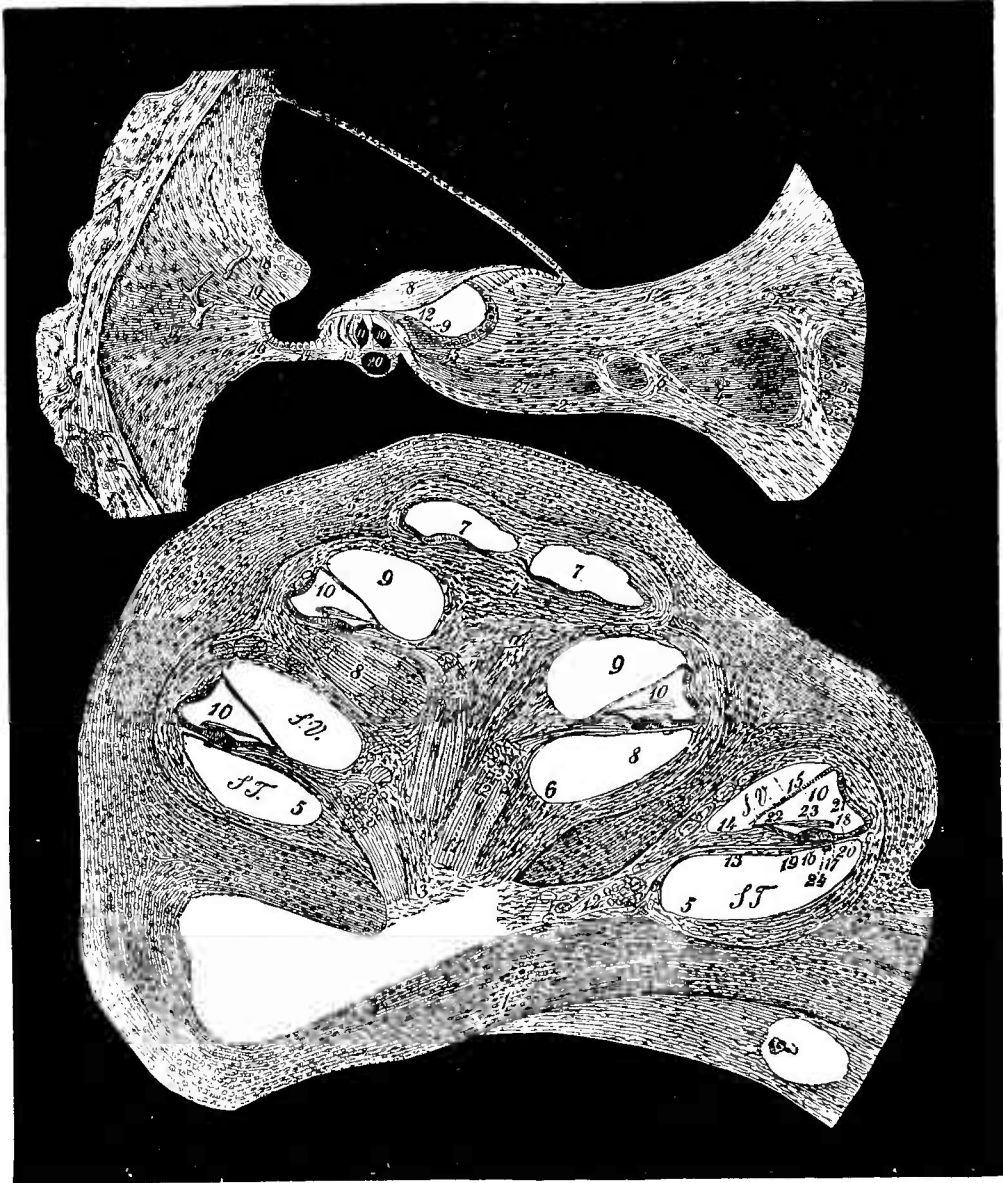

FIG. 78.—Section of the first turn of the spiral canal of a cat newly-born.—Section of the cochlea of a human fetus at the fourth month. From a photograph, and somewhat reduced. (Rüdinger.)

Upper figure: 1, 2, 6, lamina spiralis; 2, lower plate; 3, 4, 5, 5, nervus cochlearis; 7, membrane of Reissner; 8, membrana tectoria; 9, epithelium; 10, 11, pillars of Corti; 12, inner hair cells; 13, outer hair cells; 14, 16, membrana basilaris; 15, epithelium in the sulcus spiralis; 17, 18, 19, ligamentum spirale; 20, spiral canal below the membrana basilaris.

Lower figure: S T, S T, 5, 5, 7, 7, 8, 8, scala tympani; S V, S V, 9, 9, scala vestibuli; 1, base of the cochlea; 2, apex; 3, 4, central column; 10, 10, 10, 10, ductus cochlearis; 11, branches of the nervus cochlearis; 12, 12, 12, spiral ganglion; 13, 14, limbus laminae spiralis; 15, membrane of Reissner; 16, epithelium; 17, outer hair cells; 18, epithelium of the membrana basilaris; 19, nervous filaments; 20, union of the membrana basilaris with the ligamentum spirale; 21, epithelium of the peripheral wall of the ductus cochlearis; 22, 23, membrana tectoria; 24, spiral canal below the membrana basilaris.

den, he had a pain in his head, was very giddy, fell in the shrubs, and vomited. This was plainly ear vertigo, as he himself knew. But he had the following diagnoses made of his case by other medical men: 1, nothing; 2, nervousness; 3, deranged stomach.’’

That some persons who are deaf in one ear are absolutely unconscious of it is too often noticed to be now disputed. Gowers<sup>1</sup> lays stress upon this point in the following words: “The fact that the patient may be unconscious of a most significant auditory defect lessens the value of former observations as evidence of the definite character of stomachal vertigo. My own conviction is that, in the vast majority of cases in which a vertigo of definite and uniform character is apparently excited by gastric disturbance, an *auditory defect* will be discovered on careful examination.’’

Patients afflicted with diseases of the ear may, in some cases, make themselves dizzy by *pressure upon the ear* of the affected side;<sup>2</sup> while *oscillatory movements of the eyes* may occasionally accompany the vertigo dependent upon disease of the acoustic apparatus.

It is well known that the *semicircular canals* within the temporal bone, when diseased, are liable to create the so-called Menière’s malady, in which *constant vertigo* is a prominent symptom; and experiments upon birds and animals<sup>3</sup> seem to show that, in some unknown way, these canals affect coördination of movement and tend to preserve the equilibrium of the body.

When the *horizontal canal* of the bird is cut, the head is constantly moved from side to side; when the *posterior vertical canal* is cut, the head is moved up and down; when the *anterior vertical canal* is severed, the movement of the head is in a diagonal direction. If section of either of these canals be made, upon both sides of the head, the movements of the head above described are permanent; but, if made on one

<sup>1</sup> “Brit. Med. Jour.,” April, 1877.

<sup>2</sup> Schwaback, as quoted by Hughlings-Jackson.

<sup>3</sup> Flourens, 1824; Crum Brown, “Jour. Anat. Phys.,” 1874; Cyon, “Thèse pour le doctorat in medicine,” as quoted by Foster.

side only, they tend to disappear within twenty-four or forty-eight hours.<sup>1</sup> If the same class of experiments be made upon rabbits, the movements of the head are less marked, but oscillating movements of the eyeballs (nystagmus) are developed; while, if made upon certain other animals, a loss of coördination in the movements of the body and limbs is sometimes produced.<sup>2</sup>

When a person is *rotated* for some time, a sense of vertigo is produced; and this symptom seems to warrant the supposition that some abnormal effect is produced within the *semicircular canals*, through the auditory nerve filaments, possibly as a result of *concussion* of the *fluids of the ear* against the bony wall.<sup>3</sup>

The following quotation from Michael Foster,<sup>4</sup> in discussing the different theories advanced to explain coördination of movement and the various reflex phenomena which are constantly brought to the notice of the physiologist, seems particularly applicable to the practical branches of medicine: "All day long, and every day, multitudinous afferent impulses, from eye and ear, and skin and muscle, and other tissues and organs, are streaming into our nervous system, and, did each afferent impulse produce its correlative motor impulse, our life would be a prolonged convulsion. As it is,

<sup>1</sup> E. Cyon, *op. cit.*, 1878.

<sup>2</sup> The experiments of Arthur Böttcher, made in 1872, seem to conflict with those of Cyon, Goltz, and Flourens, as to the function of the semicircular canals. He claims that the section of either canal can be made without causing any symptoms of incoördination, provided the *auditory nerve filaments are not pulled upon*. The fact that the auditory nerve is not bound down at any point between the brain and the labyrinth explains, according to this observer, why the *slightest traction* upon it may injure its attachment to the medulla, and thus create the symptoms described by Cyon, Goltz, and Flourens.

<sup>3</sup> A. H. Buck, in a late treatise, reiterates his former statement, that nerves are not found in the semicircular canals, except in the ampullæ. This fact he adduces in support of the theory that they have no relation to the perception of sound impulses. He also claims that the small size of this portion of the membranous labyrinth, as compared with the diameter of the bony excavation, coupled with the peculiar reticulated arrangement which exists in the space between the membranous tube and the bony wall, further sustains his objection. This author seems to claim that the semicircular canals act as a means of relief to extreme intra-cochlear pressure. Certainly, more light is needed upon the construction of this portion of the internal ear, before its function can be positively determined.

<sup>4</sup> *Op. cit.*

by the checks and counter-checks of cerebral and spinal activities, all these impulses are drilled and marshaled, and kept in hand, in orderly array, till a movement is called for; and thus we are able to execute at will the most complex bodily manœuvres, knowing only *why*, and unconscious, or but dimly conscious, *how* we carry them out.”

The *tensor tympani muscle*, which has previously been mentioned as deriving its motor power from the fifth nerve and otic ganglion, is of use, even in the quiescent state, in preventing the membrana tympani from being pushed too far outward. During its contraction, the membranous drum of the ear is made tense, for the purpose of deadening some sounds or of favoring the reception of others, by bringing the tension of the membrane in more perfect attune to the sounds which fall upon it. It may, therefore, be considered in some respects as an *analogue to the ciliary muscle* of the eye, since both act as a sort of accommodation to a mechanism. In some persons, this muscle is under voluntary control, and thus a *crackling sound* may be produced within the ear at will, or discords be produced when musical sounds are being listened to.

The *stapedius muscle*, which derives its motor power from the facial nerve, is supposed to regulate the movements of the stapes (one of the small bones of the middle ear), and especially to prevent any sudden or excessive movement of the membrana tympani from *forcing its base* too far into the fenestra ovalis.

The *Eustachian tube* is unquestionably open *during the act of swallowing*, but it is still disputed whether it remains permanently open or is open at intervals. The swelling of the mucous membrane which lines the tube, in catarrhal inflammation, interferes with the entrance of air into the middle ear, and is frequently associated with that peculiar *ringing* or *buzzing* in the ear so often present during attacks of influenza. One of the functions of this tube is undoubtedly to afford a means of exit for the secretions of the cavity of the middle ear, and, in case of inflammation of that cavity,

should the Eustachian tube become closed, *perforation of the drum* will ensue, when the presence of the accumulated pus creates imperfect nutrition of that membrane and consequent ulceration of its coats.

Waves of sound can and do reach the endolymph of the internal ear by *direct conduction* through the skull. Since, however, sonorous vibrations are transmitted from the air to solids and liquids (and most sounds come to us through the air), some special apparatus is required to thus transfer the aërial vibrations to the fluids of the labyrinth. The late mechanical devices, recommended for the relief of perfect deafness, in which the *teeth are used* as a conducting medium, have not as yet fulfilled the predictions of their inventors.<sup>1</sup>

The deafness which often follows suppuration of the middle ear does not necessarily indicate any diseased condition of the auditory nerve, since it may be the result of *perforation* of the *membrana tympani*,<sup>2</sup> or of an abnormal condition of the *bones of the middle ear*, both of which might interfere most seriously with the transmission of sound.

Foreign bodies in the ear often create most *alarming symptoms*; and even an accumulation of wax, pressing on the drum, may create a mental condition strongly resembling the excitement of alcohol or mania.<sup>3</sup> Even syringing the ear has been known to produce fainting and severe attack of auditory vertigo. Prolonged suppuration of the middle ear may be the direct cause of fatal inflammation of the meninges of the brain.

*Neuroses* of the *acoustic nerve* are, of necessity, more obscure and difficult of detection than those of the other special

<sup>1</sup> It has long been the custom with otologists to use a tuning-fork, placed upon the forehead (when in vibration), to determine between disease of the middle ear and that of the labyrinth; since in the former the affected ear hears the tuning-fork most plainly, while, in the latter, the unaffected ear hears it most distinctly.

<sup>2</sup> *Perforation* of the *external drum* of the ear does not necessarily create deafness. That remarkable case, reported by Sir Astley Cooper, when both drums were nearly destroyed and where the patient could still hear ordinary conversation, illustrates this point.

<sup>3</sup> See case of a louse in the ear, reported by Hughlings-Jackson, "Lancet," October, 1880.

senses; since the tests of normal sight, smell, and taste are much more easy and satisfactory than the appreciation of the faculty of a fine discrimination on the part of the patient between notes of a different pitch and quality. To what extent the original and exhaustive researches of Brenner,<sup>1</sup> as to the value of the galvanic current in the diagnosis of abnormal conditions of the nerve filaments within the chambers of the labyrinth, will be sustained by pathological and clinical investigation, it is difficult now to say; but it certainly appears to shed some light upon a field of diagnosis which has been almost unexplored on account of the difficulties which have hitherto existed. It will exceed the scope of this volume to enter into the detail of this new method, since the principles of the manifestation of the electric current upon nerve tissue would have to be explained, and the different formulæ of nerve reaction given. It can, however, be stated that the principle consists of obtaining certain sensations by means of the auditory-nerve filaments, when one moistened pole of an electric battery is placed upon the tragus or the auditory meatus, and the other to the back of the neck or the inner side of the arm, and the intensity of the current regulated by means of the rheostat.<sup>2</sup> By this means the condition of acoustic hyperæsthesia and of anæsthesia may be detected with an accuracy which older methods could not afford.

The state of *acoustic hyperæsthesia* may be of central origin or dependent upon some peripheral cause. If due to the former, it may be developed in connection with chronic cephalalgia, hysteria, insanity, cerebral hyperæmia, and with irritative conditions of the brain or spinal cord. It is sometimes associated with hallucinations of hearing, especially if present as a complication of insanity. The peripheral causes of this condition comprise anything which can produce an *exaggeration of the tension* of the muscles or bones of the middle ear, thus resulting in a constant compression of the internal structures of the labyrinth. The experiments of Lucae seem to point to the *tensor tympani mus-*

<sup>1</sup> As discussed in detail by Erb, Rosenthal, and others.

<sup>2</sup> Erb's rule.

*cle* as the agent in accommodating the bones of the middle ear to the keenest appreciation of *musical tones*, while the *stapedius muscle* presides over the accommodation for *shriller* and *non-musical auditory sensations*. We can thus understand, if this be true, how paralysis of the stapedius muscle would create an hyperæsthesia of the acoustic apparatus, and, as this muscle may be affected in facial paralysis, how all of the causes of that condition may be the exciting causes also of this affection of the ear.<sup>1</sup>

The state of *anæsthesia* of the auditory nerve is always associated with some severe and persistent defect in hearing, since the filaments of the auditory nerve are no longer able to transmit the impressions of sound. Its causes are but poorly understood, but it seems positive that lesions of the posterior regions of the meso-cephalon, the medulla, and cerebellum, as well as new growths at the base of the brain, excessive intracranial pressure, and local disease of the labyrinth itself, may be thus manifested. The deafness which follows the exanthematous fevers, and is observed in hysteria and ataxia, usually indicates changes in the *meninges* of the brain, which, if severe, produce an incurable loss of hearing. Malformations of the internal or middle ear, either congenital, or acquired during childhood after cerebral diseases, are the common causes of *deaf-mutism*.

#### THE GLOSSO-PHARYNGEAL, OR NINTH NERVE.

Like the two previous nerves, both the superficial and deep points of origin of the glosso-pharyngeal nerve are situated in the medulla oblongata, a separate *gray nucleus* in the *floor of the fourth ventricle* being ascribed to it.<sup>2</sup> This nerve escapes from a groove between the *lateral tract* and the *restiform body* of the medulla, lying below the auditory nerve and above the pneumogastric, and passes out of the cavity of

<sup>1</sup> This may be deemed incompatible with statements made on page 194 of this volume, as the tensor tympani muscle was there stated to be an agent in creating auditory defect in Bell's paralysis.

<sup>2</sup> Ferrier, "Functions of the Brain," London, 1876.



the cranium by the jugular foramen, where it lies in close relation with the pneumogastric and spinal accessory nerves. the jugular vein, and the inferior meningeal artery. It possesses motor and sensory fibers, and fibers which assist in the appreciation of the special sense of taste.

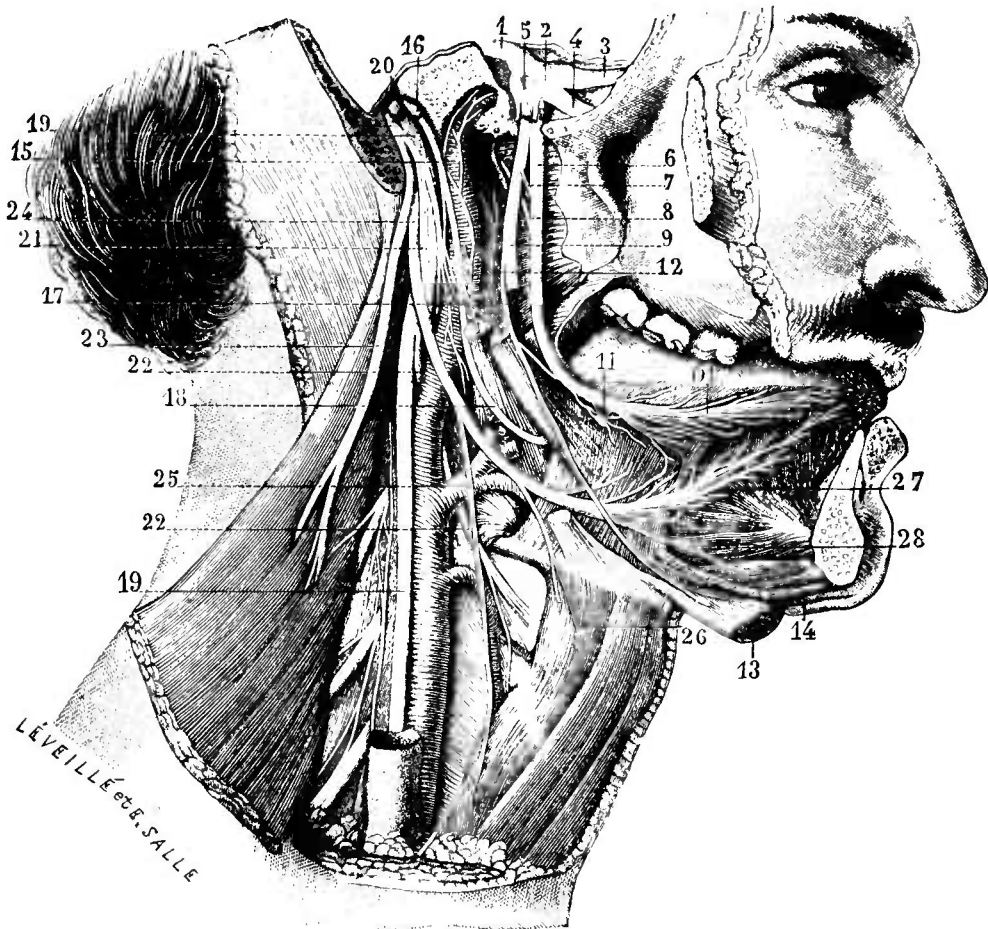

FIG. 79.—Glosso-pharyngeal nerve. (Sappey.)

1, large root of the fifth nerve; 2, ganglion of Gasser; 3, ophthalmic division of the fifth; 4, superior maxillary division; 5, inferior maxillary division; 6, 10, *lingual branch of the fifth, containing the filaments of the chorda tympani*; 7, branch from the sublingual to the lingual branch of the fifth; 8, *chorda tympani*; 9, inferior dental nerve; 10, terminal filaments of the lingual nerve; 11, submaxillary ganglion; 12, mylo-hyoid branch of the inferior dental nerve; 13, anterior belly of the digastric muscle; 14, section of the mylo-hyoid muscle; 15, 18, *glosso-pharyngeal nerve*; 16, *ganglion of Andersch*; 17, branches from the glosso-pharyngeal to the stylo-glossus and the stylo-pharyngeus muscles, 19, 19, pneumogastric; 20, 21, ganglia of the pneumogastric; 22, 22, superior laryngeal nerve; 23, spinal accessory; 24, 25, 26, 27, 28, sublingual nerve and branches.

By reference to the diagram,<sup>1</sup> it will be perceived that two ganglioform enlargements are developed upon this nerve, the upper one being situated on a level of the upper opening of

<sup>1</sup> See Fig. 80, on the following page.

the jugular foramen, while the lower one lies slightly below the

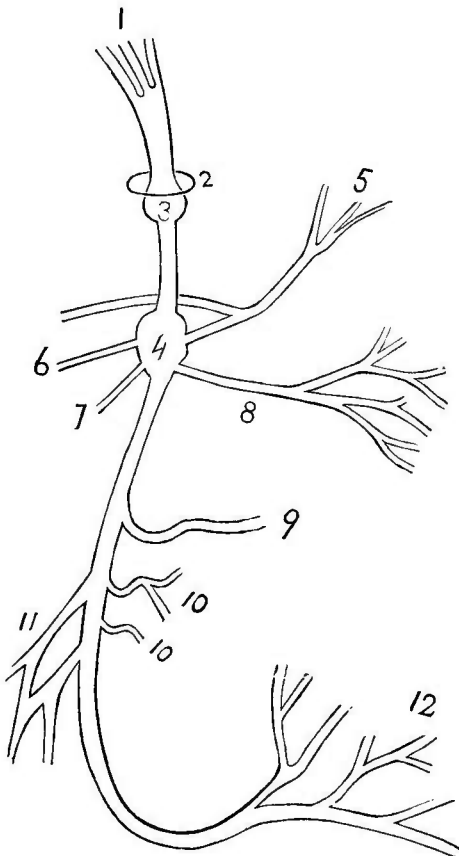

FIG. 80.—A diagram of the branches of the ninth cranial or glosso-pharyngeal nerve.

- 1, filaments of origin, extending into the medulla oblongata; 2, the *jugular foramen*, through which the nerve escapes from the cranium; 3, the *jugular ganglion*, developed upon the nerve in the *jugular foramen*; 4, the *ganglion of Andersch*, or the "*petrous ganglion*"; 5, the *auricular branch*, deriving a filament also from the pneumogastric nerve; 6, a *communicating branch* to the pneumogastric nerve; 7, a *communicating branch* to the sympathetic nerve; 8, the *tympanic branch* or "*Jacobson's nerve*," distributed to the middle ear; 9, a *communicating branch* to the carotid plexus of the sympathetic; 10, the *tonsillar branches*, distributed to the tonsil; 11, a portion of the *pharyngeal plexus*, formed also by the pneumogastric nerve; 12, the *lingual branches*, distributed to the mucous membrane and the papillæ of the base and sides of the tongue.

foramen. To the first, the name "*jugular ganglion*" is applied, while the second is called the "*ganglion of Andersch*," after its discoverer. These two ganglia do not include the same relative proportion of nerve fibers derived from the glosso-pharyngeal, since the jugular ganglion is developed upon only a portion of the nerve, while the ganglion of Andersch includes all the filaments of the trunk of that nerve.

Within the jugular foramen, the glosso-pharyngeal nerve lies in front of the spinal accessory and pneumogastric nerves, which are separated from it by a sheath which invests the two latter, and it bears an intimate relation with the jugular vein within the foramen, and also in the neck.

As a *motor nerve*,<sup>1</sup> the glosso-pharyngeal supplies the levator palati, azygos uvulæ,<sup>2</sup> stylo-pharyngeus, and the middle constrictor of the pharynx; while, as a nerve of *general sen-*

<sup>1</sup> It is extremely doubtful if the glosso-pharyngeal nerve possesses any motor fibers which are not *derived from other nerves* by filaments of communication.

<sup>2</sup> These muscles, if supplied by this nerve (as experiments seem to show), are reached by fibers sent to the facial nerve, and afterward, by means of the great petrosal branch, to Meckel's ganglion.

sation, it supplies the root of the tongue, the soft palate, the pharynx, the Eustachian tube, and the tympanum. It will be thus perceived that the glosso-pharyngeal nerve possesses,

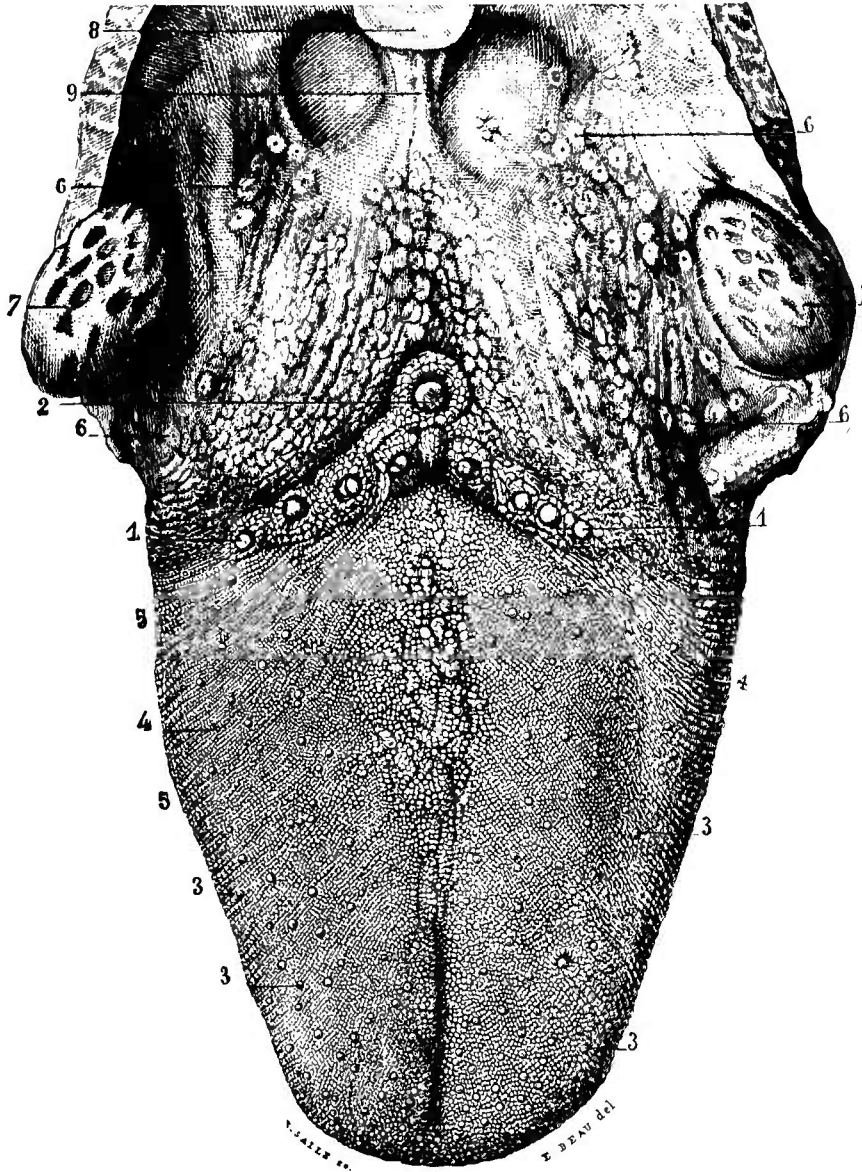

FIG. 81.—*Papillæ of the tongue.* (Sappey.)

1, 1, circumvallate papillæ; 2, median circumvallate papilla, which entirely fills the foramen cæcum; 3, 3, 3, 3, fungiform papillæ; 4, 4, filiform papillæ; 5, 5, vertical folds and furrows of the border of the tongue; 6, 6, 6, 6, glands at the base of the tongue; 7, 7, tonsils; 8, epiglottis; 9, median glosso-epiglottidean fold.

*within itself*, all the necessary fibers to insure those successive acts of a reflex type which occur during deglutition,

<sup>1</sup> It is denied by some physiologists that the *sensory filaments*, which are the main agents in exciting the reflex acts perceived during deglutition, are those of the glosso-pharyngeal nerve: since the sensory filaments of the fifth nerve distributed to the palate and pharynx from Meekel's ganglion seem to also fulfill that important function.

and it is by this nerve that the second act of deglutition is chiefly excited and performed.

The *sense of taste*, which is afforded by the glosso-pharyngeal, is confined to the *posterior third* of the tongue. A similar distribution of its sensory fibers is remarkably illustrated in that case of Hilton's, where an attack of tonsillitis produced a sympathetic *furring* of the *posterior third only* of the lateral half of the tongue.

Though analogy would lead us to suppose that a stimulus applied to any part of the course of the gustatory fibers of the glosso-pharyngeal nerve would give rise to a sensation of taste and nothing else, the proof is not forthcoming; since this nerve, as before stated, is a mixed nerve containing sensory fibers as well as those of taste.

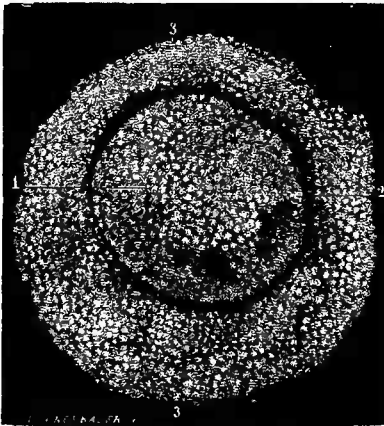

FIG. 82.

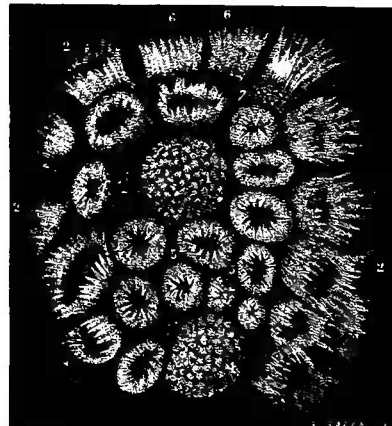

FIG. 83.

*Varieties of papillæ of the tongue.* (Sappey.)

FIG. 82.—Medium-sized circumvallate papilla: 1, papilla, the base only being apparent: it is seen that the base is covered with secondary papillæ; 2, groove between the papilla and the surrounding wall; 3, 3, wall of the papilla.

FIG. 83.—Fungiform, filiform, and hemispherical papillæ: 1, 1, two fungiform papillæ, covered with secondary papillæ; 2, 2, 2, filiform papillæ; 3, a filiform papilla, the prolongations of which are turned outward; 4, a filiform papilla, with vertical prolongations; 5, 5, small filiform papillæ, with the prolongations turned inward; 6, 6, filiform papillæ, with striations at their bases; 7, 7, hemispherical papillæ, slightly apparent, situated between the fungiform and the filiform papillæ.

Bitter substances are most tasted upon the *back of the tongue*, and sweet substances when placed *upon the tip*;<sup>2</sup> a point not without value in administering medicines. The

<sup>1</sup> "Rest and Pain." For similar effects due to the fifth nerve, see a previous lecture.

<sup>2</sup> Mich. Foster, *op cit.*

so-called "gustatory buds," which by some have been regarded as specific organs of taste, are found also upon the epiglottis, which is wholly devoid of taste; hence their function can not as yet be considered as fully determined.

As a means of refreshing your memory, the following classification of the branches of the glosso-pharyngeal nerve may prove of value. It will be seen that the tympanic branch, or Jacobson's nerve, is specially important, since it supplies portions of the middle ear which have been studied, when the auditory nerve was discussed, in their relation to the mechanism of hearing; and also because it gives a filament to two of the petrosal nerves, whose functions have been considered in connection with the seventh cranial nerve.<sup>1</sup>

A TABLE OF THE BRANCHES OF THE GLOSSO-PHARYNGEAL NERVE AND THEIR DISTRIBUTION.<sup>2</sup>

GLOSSO-PHARYNGEAL (Ninth Cranial) NERVE.	{	<ol style="list-style-type: none"> <li>1. Tympanic branch, or <i>Jacobson's nerve</i>.</li> <li>2. Carotid branches.</li> <li>3. Pharyngeal branches (help to form the <i>pharyngeal plexus</i>).</li> <li>4. Muscular branches (to muscles of the pharynx).</li> <li>5. Tonsillar branches (help to form the tonsillar plexus).</li> <li>6. Lingual branches.</li> </ol>	{	<p style="margin: 0;"><i>Communicating filaments to</i></p> <p style="margin: 0;"><i>Branches of distribution to</i></p>	<table style="border-collapse: collapse; margin: 0;"> <tr> <td style="font-size: 3em; vertical-align: middle;">{</td> <td style="padding-left: 5px;">                 Large petrosal nerve,                  Carotid plexus,                  Small petrosal nerve.             </td> </tr> <tr> <td style="font-size: 3em; vertical-align: middle;">{</td> <td style="padding-left: 5px;">                 Fenestra ovalis,                  Fenestra rotunda,                  Eustachian tube.             </td> </tr> </table>	{	Large petrosal nerve, Carotid plexus, Small petrosal nerve.	{	Fenestra ovalis, Fenestra rotunda, Eustachian tube.
{	Large petrosal nerve, Carotid plexus, Small petrosal nerve.								
{	Fenestra ovalis, Fenestra rotunda, Eustachian tube.								

EFFECTS OF SECTION.

Section of the glosso-pharyngeal nerve is followed by a type of paralysis, in which deglutition becomes an act of extreme difficulty, and in which regurgitation of food into the nostril is particularly liable to occur. The sense of *taste* in the *posterior third* of the tongue is furthermore completely destroyed, thus tending to prove that the *gustatory fibers* are *inherent to the nerve* itself, and not the result of a communication between

<sup>1</sup> Flint ascribes to the *chorda tympani nerve* the ability to perceive only *saline, acid, and styptic* qualities; and to the *glosso-pharyngeal nerve*, the appreciation of *sweet, alkaline, bitter, and metallic* tastes.

<sup>2</sup> Copied from the "Essentials of Anatomy" (Darling and Ranney). Putnam's Sons, New York, 1880.

it and some other nerve, as is claimed in reference to the gustatory fibers of the fifth.

It is stated, by some of the later investigators upon this subject, that the sense of taste is not alone confined to the tongue, but exists also in the *pillars of the fauces* and the *walls of the pharynx*, and that section of the glosso-pharyngeal nerve causes an entire abolition of this power of special sense in these latter regions, as well as in the posterior third of the tongue.<sup>2</sup>

#### THE ACT OF DEGLUTITION AND ITS MECHANISM.

The act of deglutition is, perhaps, more properly connected with the glosso-pharyngeal nerve than with any other, although that nerve assists in the performance of one stage only of the entire act. For convenience of description, it has been the custom of physiologists to divide the act of deglutition into three distinct periods. The first period, comprising

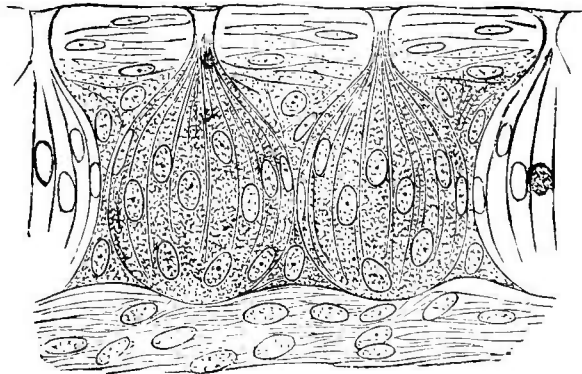

FIG. 84.—Taste buds from the lateral taste organ of the rabbit. (Engelmann.)

the passage of the bolus of food through the mouth, which is under the control of the voluntary muscles; the second, the passage of the bolus through the isthmus of the fauces and the pharynx; the third, the passage through the œsophagus to the cavity of the stomach.

In the *first period*, the food is first seized by the lips, then

<sup>1</sup> See previous lecture on the fifth nerve, and also the lecture upon the facial nerve.

<sup>2</sup> Experiments seem to point to the *fungiform* and *circumvallate papillæ* of the tongue as the chief agents in perceiving taste, if the "taste buds" of Lowén and Schwalbe are accepted as proven. See Fig. 84.

forced between the jaws by the tongue and the buccinator muscles ; and by the teeth it is not only masticated, but is also mixed with the salivary secretion. When the food is ready to be swallowed, the mouth is first closed, as the act is performed with extreme difficulty when the mouth is open, because the tongue can not properly act upon the bolus.<sup>1</sup> The tongue now becomes widened, so as to offer a large surface to the bolus of food, and, with the bolus placed behind it, is pressed backward along the roof of the mouth. In case the food to be swallowed happens to be in a liquid form, the tongue is so curved that its edges curl upward, while its dorsum is depressed in the center, thus forming a *longitudinal groove* along its entire length ; and the soft palate is so closely applied to the base of the tongue as to admit of a sucking force.

The importance of the tongue during this period of the act of swallowing can not be overestimated. Animals, in which the tongue has been paralyzed by section of the nerves of that organ, exhibit the utmost distress in their efforts to bring the food to the back portion of the mouth, and are forced to so toss the head as to bring the force of gravity to their aid.<sup>2</sup> Drinking, also, becomes even more interfered with, and the tongue is no longer used to help in the act ; hence, various devices are used to bring the fluid where the reflex act of the fauces will help to carry it to the stomach. If it were not for the fact that, after removal of the tongue for local disease, the stump was of sufficient length to be of great assistance in controlling the bolus of food, such an operation would be a questionable procedure in surgery.

It may be noticed, by those of you who have been following these remarks with care, that the glosso-pharyngeal nerve has, as yet, had no influence upon the mechanism of deglutition, since the buccinator muscles are supplied by the facial nerve, and the tongue by the hypo-glossal nerves, which have

<sup>1</sup> For the clinical proof of this fact, the reader is referred to the effects of "facial diplegia." See page 197.

<sup>2</sup> We see this also marked, but to a less extent, in patients afflicted with glosso-labial paralysis.

not, as yet, been described; but, as the second and third periods of the act are the most complex, and the second most completely under the control of that nerve, the omission of the mechanism of the first period, until the whole could be considered together, was for the purpose of making the sub-

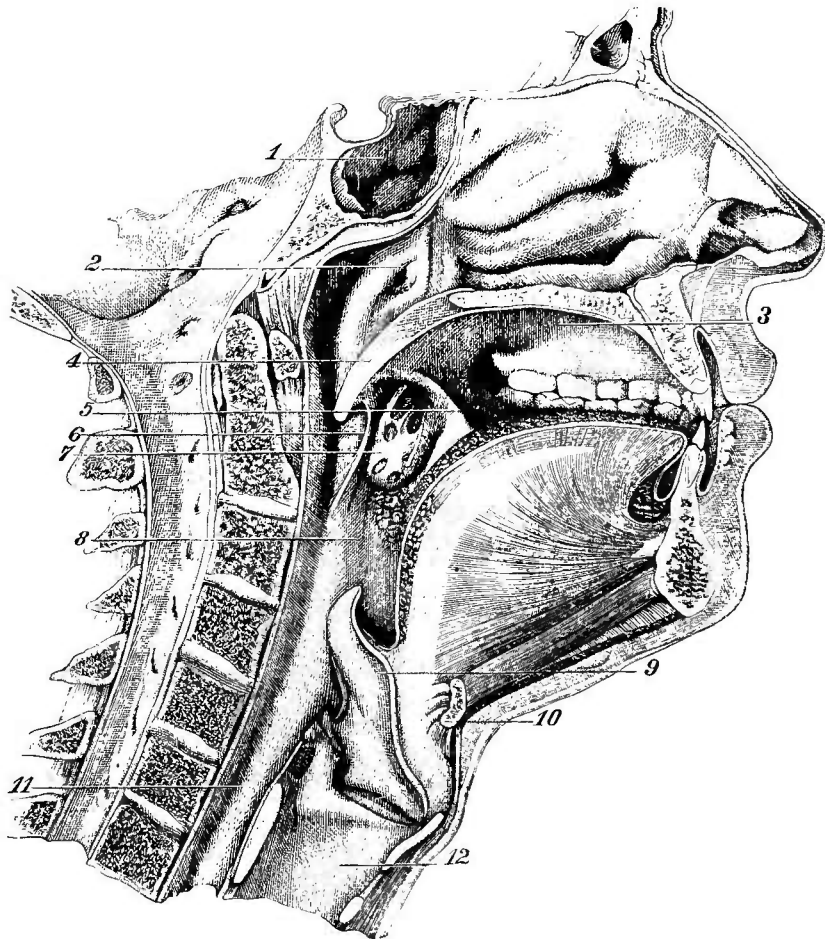

FIG. 85.—*Cavities of the mouth and pharynx, etc.* (Sappey.)

Section in the median line of the face and the superior portion of the neck, designed to show the mouth in its relations to the nasal fossæ, the pharynx, and the larynx: 1, sphenoidal sinuses; 2, internal orifice of the Eustachian tube; 3, palatine arch; 4, velum pendulum palati; 5, anterior pillar of the soft palate; 6, posterior pillar of the soft palate; 7, tonsil; 8, lingual portion of the cavity of the pharynx; 9, epiglottis; 10, section of the hyoid bone; 11, laryngeal portion of the cavity of the pharynx; 12, cavity of the larynx.

ject more easy of comprehension than if the different periods were considered separately from each other. The effect of section of the inferior maxillary branch of the fifth nerve upon the act of deglutition has been mentioned in a previous lecture, but this effect is due, not alone to an absence of the



normal muscular power of the muscles of mastication, but also to an anæsthetic condition of the mucous lining of the mouth, which renders the tongue unable to appreciate the situation of the bolus of food ; as has been proven by the fact that the same difficulty exists when section of the fifth nerve is made in front of the ganglion of Gasser, where only the sensory portion of the nerve can be injured, as when both the motor and sensory portions of the nerve are involved, after section below the foramen ovale.

In the *second period* of deglutition, the bolus of food, by being crowded backward, tends to raise the soft palate ; and the levator palati muscle further assists in retaining the palate in this elevated position, while the superior constrictor muscle of the pharynx causes the posterior wall of the pharynx to bulge forward, and thus to meet the uvula. The *posterior nasal openings* are thus mechanically closed to the entrance of the food into the chamber of the nose, preparatory to the series of reflex movements which are to ensue, for the purpose of forcing the bolus downward into the œsophagus, and thence into the stomach.

The *larynx* is now *suddenly raised*, so as to bring the superior opening of that organ underneath the base of the tongue, which has been crowded backward during the first period, in order to force the bolus against the soft palate. Its soft structure renders it admirably adapted to mold itself to the irregularities of outline of the laryngeal opening. By this position of the tongue, the epiglottis is also applied over this opening,<sup>1</sup> and the entrance of food into the larynx is furthermore guarded against by the approximation of the vocal cords by means of the adductor muscles of the larynx. The muscles which thus raise the larynx are the anterior belly of the digastric, the mylo-hyoid, the genio-hyoid, the stylo-glossus, and some of the fibers of the genio-glossus.

Simultaneously with the elevation of the larynx, the pa-

<sup>1</sup> It was formerly supposed that the epiglottis was the chief instrument in preventing the entrance of food into the larynx, but the large number of cases where the epiglottis has been removed, and no difficulty in deglutition apparently produced, have created a doubt as to its importance.

lato-pharyngeal muscles contract and *raise the lower end of the pharynx*, thus shortening the length of that organ and tending to draw the pharynx over the bolus of food, very much as a glove is drawn over the finger; while, at the same time, the curve of the posterior pillars of the pharynx is

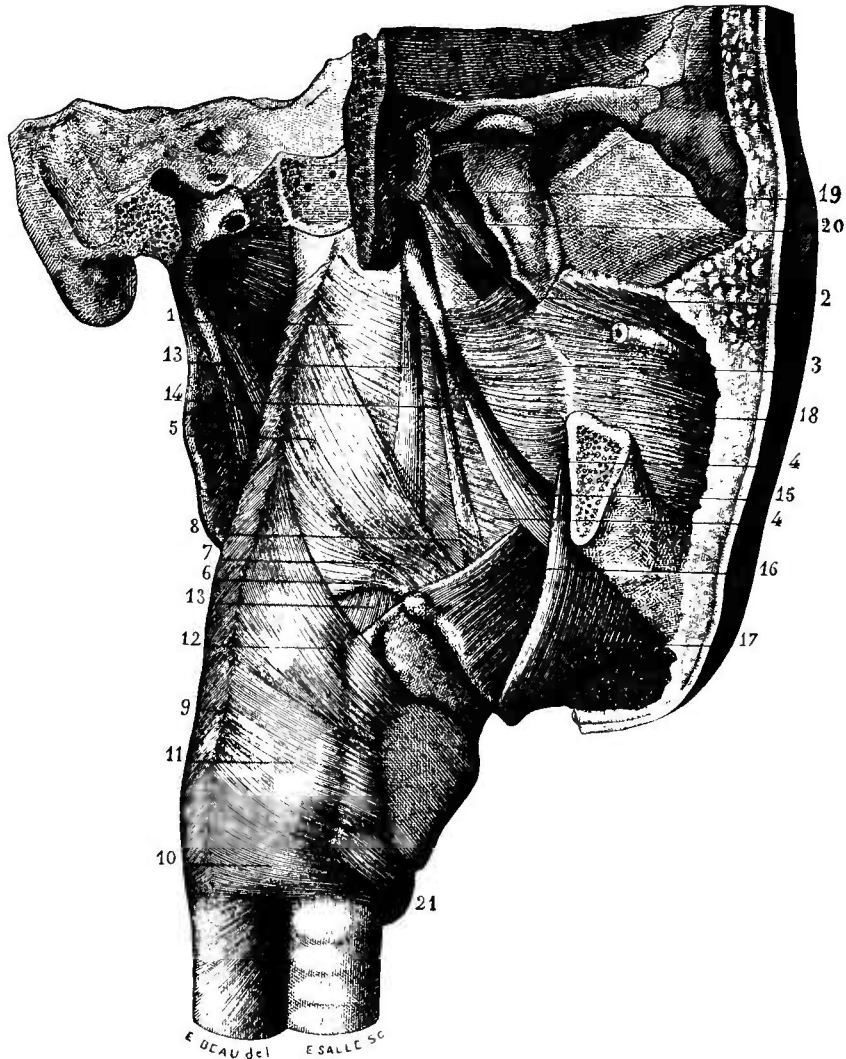

FIG. 86.—*Muscles of the pharynx, etc.* (Sappey.)

1, 2, 3, 4, 4, superior constrictor; 5, 6, 7, 8, middle constrictor; 9, 10, 11, 12, inferior constrictor; 13, 13, stylo-pharyngeus; 14, stylo-hyoid muscle; 15, stylo-glossus; 16, hyo-glossus; 17, mylo-hyoid muscle; 18, buccinator muscle; 19, tensor palati; 20, levator palati.

made straight, and, by the approximation of these muscles to the sides of the uvula, the opening of the pharynx into the nares is now completely occluded.

The constrictor muscles of the pharynx now come into

play, contracting in succession from above downward; the posterior pillars of the fauces, by their approximation, prevent the bolus from again entering the mouth; and it is thus forced to enter the œsophagus.

It is apparent that most of these movements are of a *reflex character*, and are excited by the presence of the bolus of food, which passes out of voluntary control as soon as it passes the anterior pillar of the fauces, at which point the second period of deglutition may be said to commence. Every reflex act presupposes some *sensory* filaments to convey the impression to the brain, and certain *motor* filaments to transmit the impulses to the muscles destined to act upon the bolus; it is now believed that the glosso-pharyngeal nerve possesses both of these sets of fibers, as well as those controlling the special sense of taste. This nerve may then be considered as a nerve of taste, a nerve of motion to the pharyngeal muscles, and the true "*excitatory nerve*" of the act of deglutition.

The importance of the *soft palate* in the act of deglutition is particularly shown during the swallowing of liquids, since it has to be closely applied to the base of the tongue, in order to allow of a partial vacuum within the cavity of the mouth, and thus to draw the fluid along the furrow formed by the curving upward of the edges of the tongue. This fact is clinically shown by patients affected with paralysis of the velum,<sup>1</sup> who experience great difficulty in swallowing liquids, since the fluid is liable to escape through the nose. A case of this character is reported by Bérard, where a young lady was obliged to free herself from all observation whenever she attempted to drink, as the escape by the nostrils was so profuse as to occasion embarrassment.

The prevention of the entrance of food into the cavity of the larynx, as has been mentioned, is insured: first, by the base of the tongue; secondly, by the epiglottis; and, thirdly,

<sup>1</sup> Paralysis of certain muscles of the soft palate occurs when the *facial nerve* is impaired behind the point of origin of its petrosal branches. For particulars of this diagnostic symptom, the reader is referred to page 194.

by the approximation of the vocal cords ; but that such accidents do still happen from attempts at inspiration<sup>1</sup> during eating is attested by the violent coughing excited, and by the instantaneous expulsion of the foreign substance, unless it should chance to become mechanically arrested in the larynx. Longet accounts for the symptoms excited by such an accident as the result of an exquisite sensibility possessed by the mucous lining of the upper part of the larynx. It is well attested that the danger of entrance of fluids into this organ is far greater than in the case of solids ; and the act of gargling is especially liable to be followed by such an occurrence, since the larynx is much wider open than in the act of deglutition. In the administration of anæsthetics to patients who have eaten largely before the hour appointed for surgical relief, a great danger of the entrance of vomited matters into the cavity of the larynx is encountered, since the sensitiveness of the mucous lining is destroyed, and the expulsive efforts of Nature are often wanting.<sup>2</sup>

The *third period* of the act of deglutition is confined to the œsophagus, through which the bolus has to pass to reach the stomach. The downward movement of the bolus is assisted by alternate contraction of the longitudinal fibers of the tube, which shorten it and tend to draw its walls upward over the bolus, and contraction of the circular fibers, which constrict the tube and force the bolus downward. The fact that gravity has little, if anything, to do with this downward movement is proven by the fact that the position of the body does not seem to affect it, while acrobats are often known to perform the feat while standing upon the head or hands. The time consumed in the passage through the œsophagus was estimated by Magendie<sup>3</sup> as about two minutes in animals, but

<sup>1</sup> As occurs during attacks of laughing, hiccough, etc., when food is present in the mouth, or during too hasty an effort to consume food.

<sup>2</sup> In cases where this accident occurs, the tongue should be forcibly drawn out of the mouth, so as to pull up the epiglottis, and the foreign body extracted by the finger, if possible, or, if not, the patient should be held by the feet, and thus, by shaking the patient, gravity may help to dislodge it. I once saved the life of a man by this means when all others had failed, and fatal asphyxia seemed imminent.

<sup>3</sup> "Journal de Physiol."

it is probably much shorter in man; although we are often conscious of a delayed termination of the act, and are forced to hasten it by the drinking of fluids, as most of us can attest. It is probable that this peristaltic action of the œsophagus, like that of the intestinal canal, is partly controlled by the nervous influence of the sympathetic system, although the pneumogastric nerves have an extensive distribution to and a very marked control over this organ.<sup>1</sup>

Deglutition is *essentially a reflex act*, save in its first period, when volition plays an important part. It can not take place unless some stimulus is applied to the mucous lining of the fauces; and those apparently voluntary acts of deglutition which are produced when no food is within the mouth are undoubtedly due to the swallowing of saliva, or to irritation of the fauces by the base of the tongue itself. When we tickle the fauces, we can see all of the act of deglutition, confined to the second period, artificially produced; and this irritability of the fauces is so extreme in some persons as to render any attempt to examine the throat one of difficulty, and often a cause of reflex vomiting. So important is the education of the throat to enable the patient to tolerate the presence of instruments, that all surgical procedures upon the larynx, if performed from within the mouth, require often months of training to enable the patient to assist the operator in a step whose execution may be a matter of a few seconds only. All forms of local applications are used to insure an anæsthetic condition of these parts, and the internal administration of medicinal agents is, furthermore, often required to render such procedures within the cavity of the larynx possible.

That the *center for the reflex act of deglutition* is confined to the medulla oblongata is proven by experiment on animals whose brain has been entirely removed, with the exception of the medulla, when irritation of the fauces will still continue

<sup>1</sup> Michael Foster regards this third act of deglutition as more closely dependent upon the *central nervous system* than the movements of the intestinal tract, and attributes it to reflex action due to the bolus.

to produce all the movements of the second stage of that act.

CLINICAL POINTS OF INTEREST PERTAINING TO THE GLOSSO-PHARYNGEAL NERVE.

The intimate association which apparently exists between the fibers of this nerve and the sense of taste, the movements of the pharyngeal muscles, and the reflex acts excited by the presence of a bolus or of some foreign source of irritation to the isthmus of the fauces and the walls of the pharynx, would seem to suggest that any impairment of the glosso-pharyngeal would be followed by clinical evidences of imperfect performance of each and all of these functions. It is, however, to be regretted that the questions of the course, origin, and functions of the chorda tympani nerve, the exact distribution of the fibers of the glosso-pharyngeal nerve to the tongue, and the source from which this latter nerve derives its motor filaments, are, as yet, disputed points among physiologists; and the sources of doubt are not removed, but rather increased, by the results of pathological observation, since they often seem contradictory, and thus prove rather a source of embarrassment than an aid to definite conclusions.

One would naturally suppose, provided that he was familiar with the symptoms of that disease, called by Duchenne "glosso-labio-laryngeal paralysis" (although the word "pharyngeal" is often used in place of "laryngeal" to express the same condition), that the difficulty experienced in deglutition would certainly indicate that the nerve which apparently presides over that function would be found in a state of disease; but, on the contrary, the glosso-pharyngeal nerve is not reported, to my knowledge, as having anything to do with that affection. We must, therefore, be forced to infer that the motor filaments of the pharynx are, to a great extent, controlled by other nerves; and that, if they are apparently branches of the ninth cranial nerve, they are to be accounted for as fibers derived from communicating filaments from other sources.

Hirschfeld claims to have verified a branch of the glosso-pharyngeal nerve which extends to the *anterior two thirds* of the tongue; hence the strong probability that it partially controls the sense of taste in that portion as well as in the posterior third of the organ. Stannius, by experiments, thinks that he has established the function of this branch, and he attributes to it the power of perception of *bitter substances* only, the other varieties of taste sensations being presided over by the chorda tympani nerve or the gustatory branch of the fifth nerve. We know, clinically, that the conditions of hyperæsthesia and anæsthesia of the gustatory nerves are verified by many interesting phenomena; and we must be content to wait for the solution of the other mixed problems of gustation, until they are solved by further clinical, physiological, and pathological observation.

The condition of *gustatory hyperæsthesia*, called also "*hypergeusia*,"<sup>1</sup> is very marked in certain patients who are in an anæmic and nervous condition, while it is a frequent phenomenon in hysteria and in melancholia. In such cases an apparent gustatory sensation may be often excited by the application of an electric current to the cervical or upper dorsal region of the spine.

True gustatory hyperæsthesia may express itself as an increase in the delicacy of the gustatory sensation, so that extremely small quantities of sapid substances may be perceived. We thus occasionally meet with hysterical patients, who can perceive the taste of certain medicinal agents in a solution which to the healthy subject would be tasteless. It may express itself, again, as an unnatural enjoyment of food, or a loathing of certain dishes which convey a sense of taste which does not in reality exist. In facial paralysis of rheumatic origin, abnormal gustatory sensations are sometimes present, as sweetish, sour, or sapid tastes, within the mouth. In the insane, hallucinations of the special sense of taste, usually of

<sup>1</sup> See experiments of Valentin and Keppler, made to determine the exact degree of gustatory sensibility and excitability.

a disagreeable character, are often present, and indicate some disease of central origin.

The condition of *gustatory anæsthesia*, called "*ageusia*," comprises all those phenomena which indicate either a partial or complete loss of the sense of taste. Thus, the tongue may be able to appreciate certain substances, and be insensible to others, while the anæsthetic condition may be circumscribed or diffused, as regards its anatomical distribution, affecting either the tip of the tongue, its root, or one or both sides. This abnormal state is observed after paralysis of the trigeminus, severe injuries to the trigeminus or the glosso-pharyngeal nerves, intra-cerebral growths which create compression of the glosso-pharyngeal or trigeminus,<sup>1</sup> and atrophy of the nerves, as the result of compression, of disease of their inherent fibers. As a rule, when this condition exists, we shall find a similar condition of the optic, olfactory, trigeminus, pneumogastric, spinal accessory, or some of the cutaneous branches to the face.

#### THE PNEUMOGASTRIC, OR TENTH NERVE.

Owing to the numerous connections of the pneumogastric with other nerves, its varied and extensive distribution, and the important character of its functions, this may properly be regarded as one of the most remarkable nerves of the whole body. It has been often known by the name of the "*par vagum*," from the wandering course of its fibers, which are distributed to five different vital organs, viz. : the heart, lungs, stomach, liver, and intestines, as well as to many other parts of secondary importance.

This nerve, like the seventh, eighth, and ninth nerves, is considered by comparative anatomists as belonging to the

<sup>1</sup> In the case reported by Böttcher, although *ageusia* existed, the patient complained of a constant burning and bitterness within the mouth. An autopsy showed the presence of a tumor of the base of the brain, which had caused atrophy of the glosso-pharyngeal and pneumogastric nerves by a steady compression. Longet reports cases where the nerves passing through the jugular foramen were all more or less destroyed by pressure from a similar cause.



class of spinal nerves, since it arises directly and entirely from the upper portion of the spinal cord. Its superficial point of origin lies in the groove between the *olivary* and *restiform bodies* of the medulla, while its deep point of origin may be traced to a gray nucleus in the floor of the fourth ventricle, slightly below the nucleus for the glosso-pharyngeal nerve.

There is a very close affiliation between the deep fibers of the pneumogastric and glosso-pharyngeal nerves within the

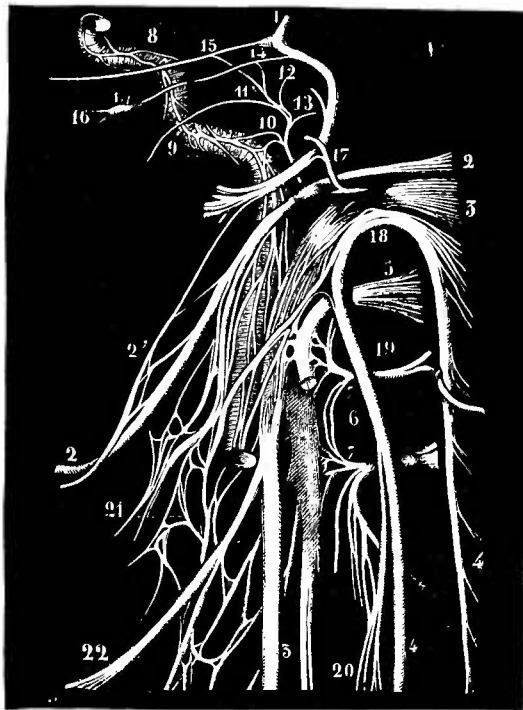

FIG. 87.—*Anastomoses of the pneumogastric nerve.* (Hirschfeld.)

1, facial nerve; 2, glosso-pharyngeal nerve; 2', anastomoses of the glosso-pharyngeal with the facial; 3, 3, *pneumogastric, with its two ganglia*; 4, 4, *spinal accessory*; 5, sublingual nerve; 6, superior cervical ganglion of the sympathetic; 7, *anastomotic arcade of the first two cervical nerves*; 8, carotid branch of the superior cervical ganglion of the sympathetic; 9, nerve of Jacobson; 10, branches of this nerve to the sympathetic; 11, branch to the Eustachian tube; 12, branch to the fenestra ovalis; 13, branch to the fenestra rotunda; 14, external deep petrosal nerve; 15, internal deep petrosal nerve; 16, otic ganglion; 17, *auricular branch of the pneumogastric*, 18, *anastomosis of the pneumogastric with the spinal accessory*; 19, *anastomosis of the pneumogastric with the sublingual*; 20, anastomosis of the spinal accessory with the second pair of cervical nerves; 21, pharyngeal plexus; 22, superior laryngeal nerve.

substance of the medulla oblongata, so close indeed as to lead some authors to consider them identical with each other. These deep fibers may be traced, in part, into the substance of the restiform body, a small bundle toward the cerebellum,

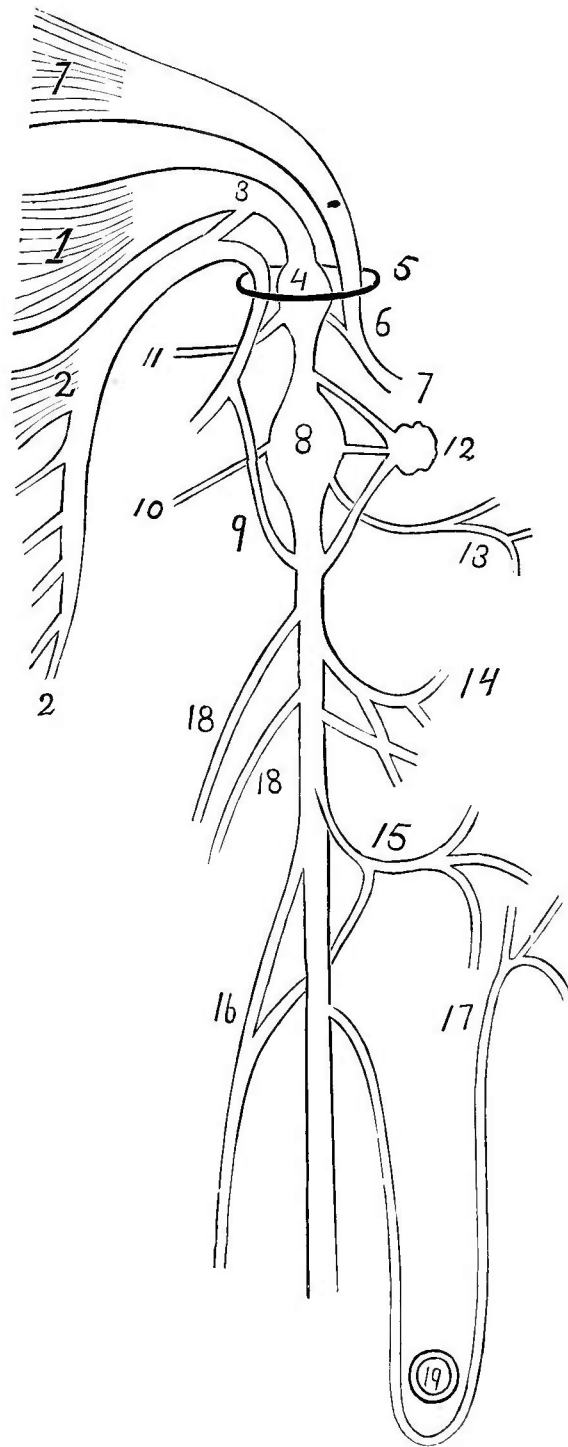

FIG. 88.—A diagram showing the branches of distribution and communication of the pneumogastric nerve. Cervical portion of nerve.

- 1, the filaments of origin of the pneumogastric nerve; 2, the *spinal accessory* nerve escaping from the medulla oblongata, below the pneumogastric nerve; 3, the upper communicating filament between the *pneumogastric* and the *spinal accessory* nerves (often absent); 4, the "*ganglion of the root*," situated in the jugular foramen; 5, the *jugular foramen*, showing the transmission of three nerves; 6, the communicating filament between the *pneumogastric* and the *glosso-pharyngeal* nerves; 7, the *glosso-pharyngeal* nerve, from its point of origin to its escape from the cavity of the cranium; 8, the "*ganglion of the trunk*" of the pneumogastric nerve; 9, the *lower filament* of

communication between the *pneumogastric* and *spinal accessory nerves*, which probably controls the muscles of the larynx concerned in phonation and respiration; 10, the *communicating filament* from the areolæ, formed by the first and second cervical nerves; 11, the *communicating filament* from the *facial* nerve, which helps to form the auricular branch of the pneumogastric or "Arnold's nerve"; 12, the *three sets* of filaments which join the pneumogastric nerve to the *superior cervical ganglion* of the sympathetic system; 13, the *auricular branch* of the pneumogastric, or "*Arnold's nerve*," partly formed by the facial filament (11); 14, the *branches* to the "*pharyngeal plexus*," formed also in part by the glosso-pharyngeal; 15, the *superior laryngeal* nerve, supplying the mucous lining of the larynx and the crico-thyroid muscle; 16, the "*depressor nerve of the heart*," formed by two roots, one from the pneumogastric, and the other from the superior laryngeal nerve;<sup>1</sup> 17, the *inferior* or *recurrent laryngeal* nerve, winding around an artery (19), and then returning to the larynx to supply the muscles of phonation;<sup>2</sup> 18, the *cervical cardiac* nerves (sometimes three in number), going to the cardiac plexus; 19, the *subclavian artery* (if on the right side), and the *arch of the aorta* (if on the left side of the body).

and a few toward the cerebrum; but the larger portion pass to the median line of the floor of the fourth ventricle or descend into the substance of the medulla oblongata.

The pneumogastric nerve emerges from the jugular foramen as a single trunk, but immediately develops two ganglia, the upper of which is called the "*jugular ganglion*," or the "*ganglion of the root*," since it lies close to and sometimes within the foramen of that name. After the nerve emerges from the foramen, another ganglion, about one quarter of an inch in length, is developed, called the "*ganglion of the trunk*." Within the jugular ganglion, an interchange of fibers takes place between the pneumogastric and spinal accessory nerves; and it seems clear that the laryngeal and pharyngeal branches (which are among the most decidedly motor of those given off from the pneumogastric) may all, in great part, be traced backward into the spinal accessory nerve.

The researches of Valentin, Morganti, Longet, and others seem to prove that the pneumogastric nerve at its root possesses no motor power, but is entirely an afferent nerve, although Stilling, Wagner, Müller, Volkman, and Bernard fail

<sup>1</sup> For the physiological effect of stimulation of this nerve, see the late researches of Cyon and Ludwig upon this nerve in the rabbit; also text-books of physiology of Michael Foster, A. Flint, Jr., and others. In man, this nerve is probably associated with one of the cardiac nerves.

<sup>2</sup> The filament of the spinal accessory (No. 9 in the cut) is supposed to afford to this nerve its motor power, having simply used the sheath of the pneumogastric as a means of protection in its course down the neck. The physiological import of this nerve shows the vital necessity for such protection.

to attribute all the motor fibers of this nerve to either the spinal accessory or glosso-pharyngeal nerves, and maintain that motor fibers may be demonstrated within the root of the pneumogastric above the jugular ganglion.

In regard to its *trunk*, there can be no doubt that the pneumogastric is to be considered as a nerve of double endowments, although it is certain that these endowments are very differently distributed among its branches. That it is capable of conveying those impressions which become *sensations* when communicated to the sensorium is experimentally proved by the fact that, when its trunk is pinched, the animal gives signs of acute pain ; and it is also evident from the painful consciousness we occasionally have of any abnormal condition of the organs which it supplies.

#### BRANCHES OF THE PNEUMOGASTRIC NERVE.

The pneumogastric nerve, by means of its numerous points of distribution, participates in the operations of *deglutition*, *phonation*, *respiration*, the *circulation of the blood*, and the *process of digestion*. To fully describe the variations in its course from above downward, and the distribution of its branches to the various organs (in all of their physiological bearings), you must, of necessity, be carried into a discussion of the thoracic and abdominal viscera and the physiological acts which they perform. A hasty enumeration of the general course of the fibers of this nerve can, therefore, only be given here, reserving the many points of interest connected with it for other lectures, when the viscera will be considered.

The *efferent fibers* of the pneumogastric nerve include certain motor branches which are distributed into the pharynx, the larynx, the œsophagus, the stomach, and the intestinal canal.

The *pharyngeal branches* help to form the pharyngeal plexus of nerves, and thus to aid in the movements of the muscles of that organ during the second period of deglutition.<sup>1</sup>

<sup>1</sup> See lecture upon the glosso-pharyngeal nerve, where the act of deglutition is fully discussed.

It is also probable that these same muscles tend to modify the *tone and quality of the voice*, and also to assist in the

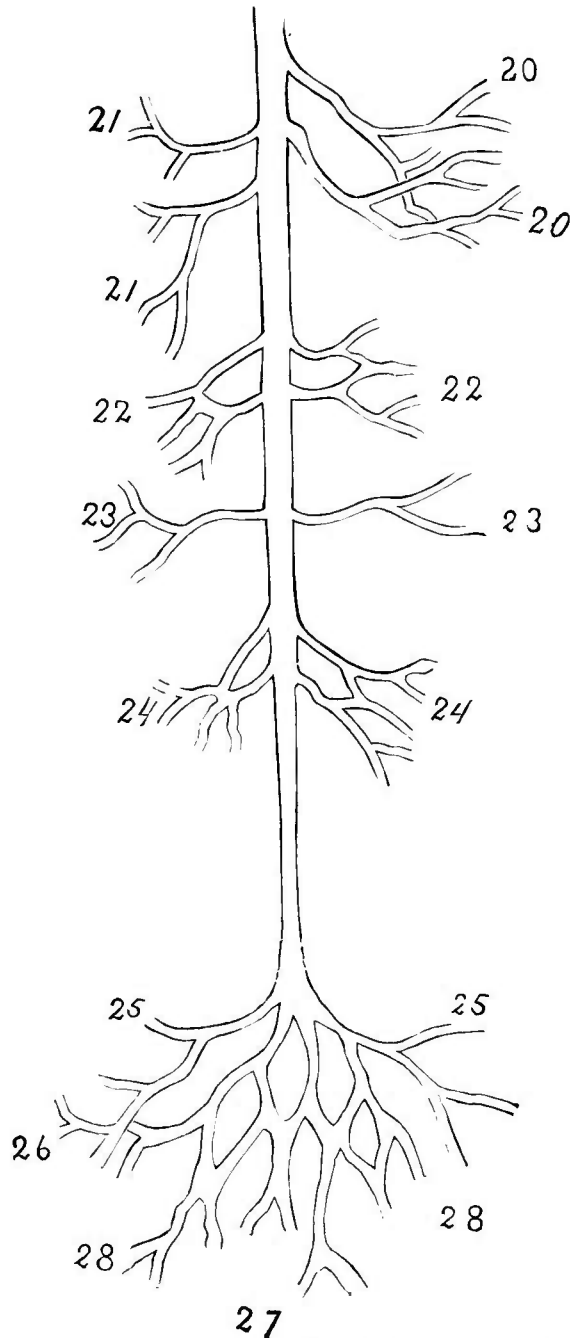

FIG. 89.—Thoracic and abdominal portion of the nerve.

20, the *thoracic cardiac nerves*, assisting to form the cardiac plexus ; 21, the filaments of communication between the *pneumogastric nerve* and the *thoracic ganglia* of the sympathetic system ; 22, the branches given off by the pneumogastric nerve to assist in forming the *posterior pulmonary plexus* ; 23, the branches given off to assist in forming the *anterior pulmonary plexus* ; 24, the branches which form the *œsophageal plexus*, and assist in the performance of the third period of the act of deglutition ; 25, the *gastric branches*, supplying the coats of the stomach ; 26, the *hepatic branches*, accompanying the portal system of veins ; 27, the *intestinal branches*, controlling, to a large extent, the peristaltic action of that canal ; 28, branches which can be traced to the *kidneys*, the *spleen*, and the *supra-renal capsules*.

articulation of sounds or words, although the lingual muscles and those of the lips are more directly concerned in the latter function.

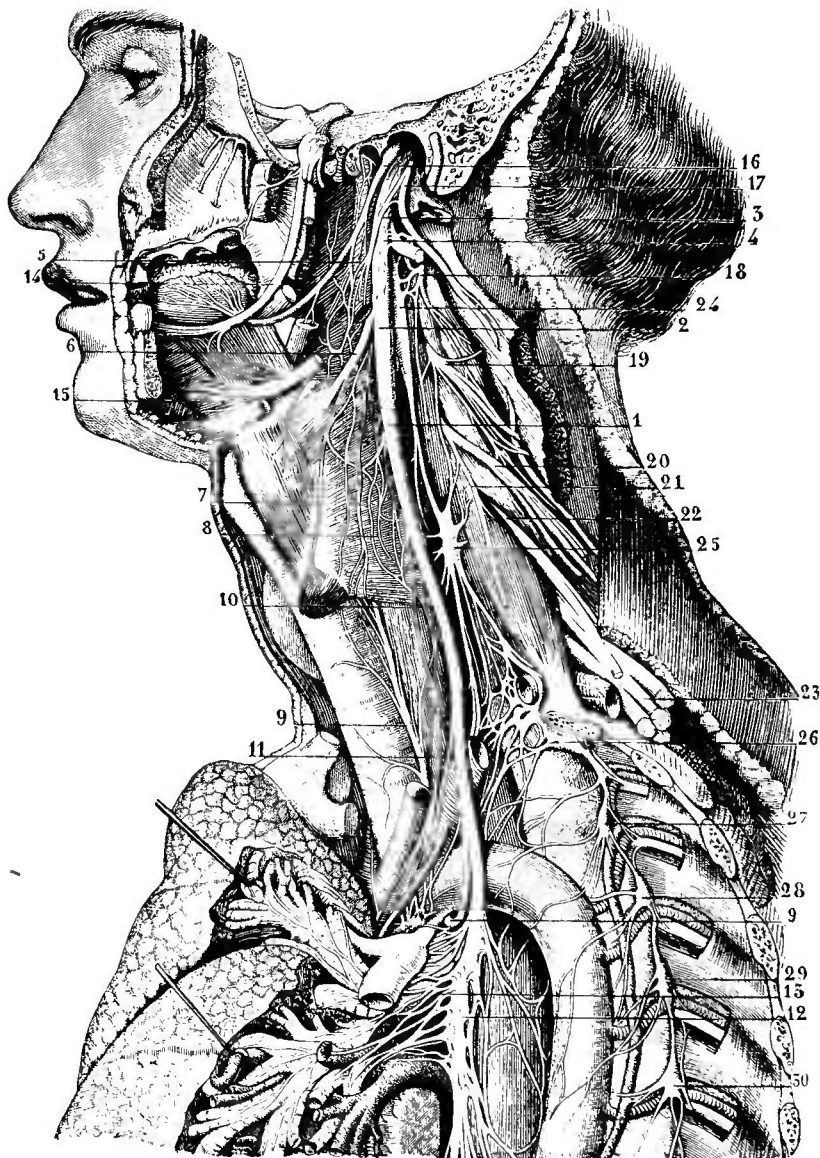

FIG. 90.—Distribution of the pneumogastric. (Hirshfeld.)

1, trunk of the left pneumogastric ; 2, ganglion of the trunk ; 3, anastomosis with the spinal accessory ; 4, anastomosis with the sublingual ; 5, pharyngeal branch (the auricular branch is not shown in the figure) ; 6, superior laryngeal branch ; 7, external laryngeal nerve ; 8, laryngeal plexus ; 9, inferior laryngeal branch ; 10, cervical cardiac branch ; 11, thoracic cardiac branch ; 12, 13, pulmonary branches ; 14, lingual branch of the fifth ; 15, lower portion of the sublingual ; 16, glosso-pharyngeal ; 17, spinal accessory ; 18, 19, 20, spinal nerves ; 21, phrenic nerves ; 22, 23, spinal nerves ; 24, 25, 26, 27, 28, 29, 30, sympathetic ganglia.

The *laryngeal branches* are two in number, and are called the superior and inferior ; although the name “recurrent laryngeal nerve” is more often applied to the latter on account

of the peculiarity of its course, since it winds around the subclavian artery before returning to the larynx, upon the right side of the body, while the left nerve winds around the arch of the aorta, and then turns backward, to be distributed to the muscles of the larynx. It is by means of these laryngeal nerves that the *muscles which move the vocal cords*, and thus control the voice, are supplied; while the same muscles are important agents in so adapting the size of the opening between the vocal cords, during inspiration, as to allow of an unimpeded entrance of air to the lungs.<sup>1</sup> As the *inferior nerve* is the one which supplies all of the laryngeal muscles but the crico-thyroid and a portion of the arytenoid, it becomes to the physiologist a nerve of great importance, since the acts of respiration and phonation are directly under its influence. Experiment seems to have proven, however, that the laryngeal nerves, although apparently deriving their motor power from the pneumogastric, are, in reality, but fibers of the *spinal accessory nerve*, which have used the sheath of the pneumogastric nerve simply for protection in their passage through the neck. The spinal accessory nerve is, therefore, sometimes called the "superior respiratory nerve of Bell," since it controls the movements of the laryngeal muscles during the act of inspiration;<sup>2</sup> which are the highest, in point of situation, of any of the respiratory muscles.

The *branches* to the *oesophagus*, *stomach*, and *intestine* are the principal agents in promoting the peristaltic action of the alimentary canal, and they thus aid in the acts of deglutition and digestion. It is probable, also, that the pneumogastric nerves are capable of directly affecting the *secretions* of the alimentary canal, although the sympathetic system is

<sup>1</sup> The researches of Bernard have done much to call professional attention to the fact that the pneumogastric and spinal nerves are alone involved in ordinary respiration, but that, when it becomes necessary to bring the respiratory movements into perfect accord with the requirements of animal life (as in adapting the action of the muscles of the larynx to production of voice), the spinal accessory nerve becomes an indispensable aid.

<sup>2</sup> This statement is one that will admit of question. The reader is referred to the experiments of Bernard and Bischoff (as given on a subsequent page) for the difference between the effect of the spinal accessory fibers upon the glottis from those of the pneumogastric itself.

still regarded as the means by which these nerves exert their influence upon that portion of the body.

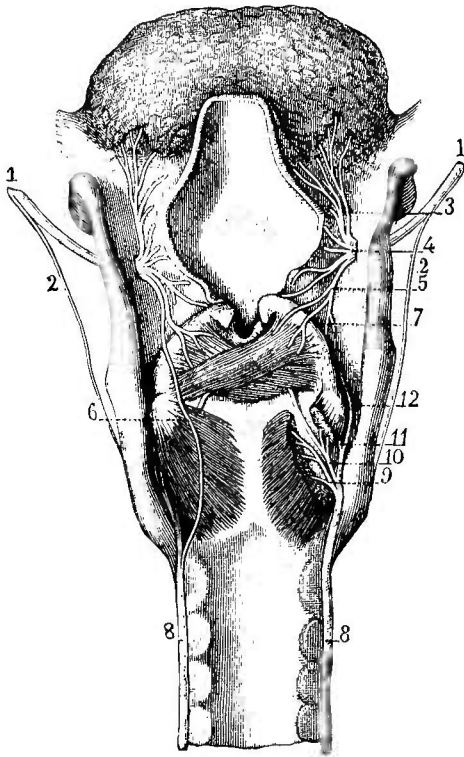

FIG. 91.—Nerves of the larynx, posterior view. (After Sappey.)

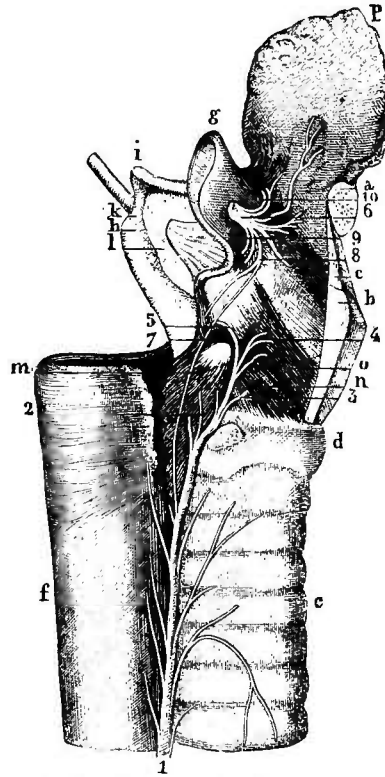

FIG. 92.—Nerves of the larynx, lateral view. (After Hirschfeld.)

FIG. 91.—1, 1, superior laryngeal nerves passing through the thyro-hyoid membrane; 2, 2, external laryngeal branch supplying the crico-thyroid muscle; 3, ascending branches distributed to the mucous membrane of the tongue; 4, transverse branches distributed to the mucous membrane of the epiglottis and the aryteno-epiglottidean folds; 5, descending branches passing to the mucous membrane covering the posterior surface of the larynx (two of these, of considerable size, cross the arytenoid muscle to supply the mucous membrane lining the walls of the vestibule); 6, branch connecting the superior with the inferior laryngeal nerve; 7, the same branch divided near its point of origin; 8, 8, inferior laryngeal nerve; 9, branch to the posterior crico-arytenoid muscle, which is here divided in order to show the next nerve; 10, branch to the arytenoid winding under the lower border of the muscle so as to enter it from its inner surface; 11, branch to the lateral crico-arytenoid muscle; 12, branch to the thyro-arytenoid muscle.

FIG. 92.—*a*, section of the hyoid bone; *b*, section of the thyroid cartilage; *c*, thyro-hyoid membrane; *d*, cricoid cartilage; *e*, trachea; *f*, oesophagus; *g*, epiglottis; *h*, superior cornu of the thyroid cartilage; *i*, great cornu of the hyoid bone; *k*, lateral thyro-hyoid ligament; *l*, thyro-hyoid membrane; *m*, posterior crico-arytenoid muscle; *n*, lateral crico-arytenoid muscle; *o*, thyro-arytenoid muscle; *p*, base of the tongue; 1, recurrent laryngeal nerve; 2, branches given off from this nerve to the posterior crico-arytenoid muscle; 3, branch to the lateral crico-arytenoid muscle; 4, branch to the thyro-arytenoid muscle; 5, branch to the arytenoid muscle; 6, right superior laryngeal nerve; 7, anastomosis of this nerve with the inferior laryngeal; 8, descending branches from the superior laryngeal; 9, middle branches of the same nerve; 10, ascending branches.

In addition to the branches, which are considered as of the greatest physiological importance, certain other *motor fibers*



are now traced with tolerable certainty to the trunk of the pneumogastric nerve, which are not unimportant. Thus we may include certain nerves which supply the plain muscular fibers of the trachea and of the larger bronchial tubes, fibers which exert a *vaso-motorial influence* upon the blood-vessels of the lungs, an *inhibitory nerve for the heart*, and certain fibers which are distributed to the lungs and the heart, which are supposed to exert a *trophic influence*.

The properties and functions of the *cardiac nerve*, and in what way the pneumogastric nerve influences the action of the heart, are physiological questions of the greatest importance. It is now known that section of the pneumogastric in the neck, instead of arresting the action of the heart, *increases the frequency* of its contractions; while galvanism of the divided ends causes the heart's action to *stop during its diastole*, if the current be a powerful one, and, if a weak one, the heart's action is proportionately slowed.

The *depressor nerve of the heart* is shown,<sup>1</sup> in the diagrammatic representation of the pneumogastric nerve and its branches, to arise from two filaments, derived, respectively, from the pneumogastric and the superior laryngeal nerves. The importance of this nerve in explaining

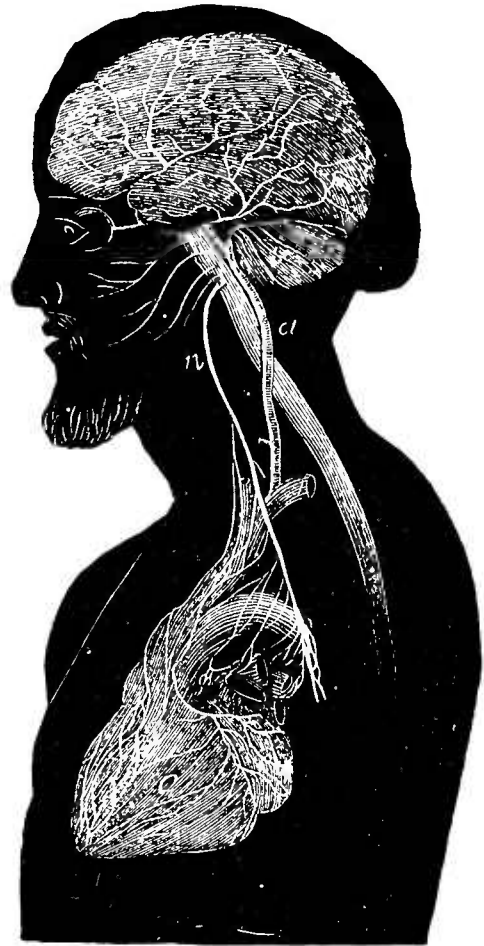

FIG. 93.—Branches of the pneumogastric to the heart. (Bernard.)

C, heart; a, carotid artery going to the brain; n, branches of the pneumogastric going to the heart.

<sup>1</sup> For the method of origin of this nerve, see the diagrammatic plate of the upper half of the pneumogastric nerve, page 238. While the diagram illustrates the construction of this nerve, as found in the rabbit by Cyon, it is still questionable whether a similar method of origin can be demonstrated in man. That the nerve exists is not a matter of doubt; but it is impossible to positively state its method of origin or its precise course.

many physiological effects of galvanism of the pneumogastric has been developed through the efforts of Cyon and Ludwig, in their prize essay of 1867, who showed to the profession its power of decreasing the beats of the heart, and who thus afforded the means of satisfactorily explaining many phenomena met with in the daily practice of medicine. If the abdomen of a frog be exposed, and the intestine struck sharply, the heart will be seen to stand still, as if the depressor nerve of the heart had been galvanized; while stimulation of the mesenteric nerves, before they join the sympathetic chain, will have a like result. It has been found that the irritation of an inflamed peritoneal surface, even if gently practiced, will decrease the heart pulsations, and that *severe shock or very intense pain*, no matter where it arises, will also have the same effect upon the heart.

Such evidences of reflex action are apparently transmitted through these depressor nerves of the heart alone, and they help us to explain why pain may create, in the human race, attacks of fainting, and why some types of inflammatory diseases and states of collapse and shock are associated with a decrease in the pulsations of the heart. The action of *atropin*, even in small doses, seems to entirely arrest the influence of this nerve upon the heart, and a guide to the administration of this drug may thus be derived from physiology, while the effects thereof may, in some instances, be thus made clear.

The *cardiac nerves* of the pneumogastric are undoubtedly connected with the other nerves of the *cardiac ganglia*,<sup>1</sup> and act upon the heart fibers indirectly, rather than directly, without the intervention of the ganglion. It has lately been proven that certain *other cardiac nerves*, whose function is acceleratory, rather than depressing, to the heart, can be traced to the *cervical portion* of the *spinal cord* as their point of origin, but they have no connection with the pneumogastric nerve.

<sup>1</sup> The vaso-motor nerves of the lung are derived, according to Franck, from the upper cervical ganglia of the sympathetic, their primary origin, however, being in the cervico-dorsal region of the cord.

The *afferent fibers* of the pneumogastric nerve, or those which carry impressions from the periphery of the nerve toward its point of origin, comprise the sensory filaments<sup>1</sup> distributed to the entire respiratory tract; and also those sensory nerves which supply the pharynx, the œsophagus, and the stomach; fibers which assist to produce the secretion of the saliva; fibers which tend to arrest the secretion of the pancreas; a special *inhibitory* nerve upon the *vaso-motor center* of the medulla oblongata; and, finally, a special set of fibers which both augment and retard, at will, the action of the *respiratory center* of the medulla oblongata.

As the pneumogastric nerve is more apparently, although perhaps not more importantly, connected with the *act of respiration*, we will first consider the two sets of fibers which have been mentioned above as influencing the action of the respiratory center. It has been shown by Rosenthal that the superior laryngeal nerve, when stimulated by a galvanic current, decreases the number of respirations, while the main trunk of the pneumogastric nerve, when similarly stimulated, tends to increase the number of respirations. Thus, the fact that the vagus nerve possessed *two sets of respiratory fibers*, an acceleratory and an inhibitory, seems to be well established, although some observers have not, as yet, admitted the positiveness of the experiment.

As regards those branches of the pneumogastric which seem to exert a specific influence upon the *various secretions* of the alimentary canal, we have yet much to learn. As a general rule, it may be stated that anything which tends to create an increased activity in the epithelial cells, rather than in the blood supply of the part, tends also to increase the secretion. Thus a drug may excite any special secretion, first,

<sup>1</sup> Sommerbrodt ("Centralbl. f. d. med. Wiss.," December, 1880) points out a mechanism of compensation by which the action of the lungs and of the heart is coördinated. Thus, a rise in the intra-bronchial pressure (as occurs in singing, crying, coughing, etc.), by irritating the sensory nerves of the lungs, excites a reflex depressing action on the vaso-motor and cardio-inhibitory nerves. The resulting vascular dilatation and acceleration of the heart's action react upon the lung in two ways. They prevent the natural tendency to stasis of the blood in the bronchial walls, and they insure the rapid renewal of oxygen, demanded by the increase in pulmonary activity.

by acting upon the nerve center which controls that part ; secondly, by a reflex act through the nerves of the part ; thirdly, by acting as a direct chemical stimulus to the cells ; and, fourthly, by increasing the amount of blood in the part, through dilatation of the blood-vessels.

That an *inhibitory effect* upon the *vaso-motor center* of the medulla is possessed by some of the fibers of the pneumogastric nerve, is proven by the effect of galvanism of the vagus upon blood pressure ; since, when the depressor nerve of the heart is divided and the end connected with the brain is galvanized, the *blood pressure* falls, although the heart is not affected, as it would be if the cardiac portion of the nerve were stimulated.

#### COURSE OF THE PNEUMOGASTRIC NERVE OF THE TWO SIDES.

The important functions of the vagus render it necessary that every precaution shall be taken by Nature to prevent its possible injury, especially during its passage through the neck ; since, within the thorax and the cavity of the abdomen, the viscera and the bony encasements tend to render all possible dangers of injury a minimum. We therefore find this nerve inclosed within the sheath of the carotid artery, where it is placed *between the artery and the internal jugular vein*, lying also *posteriorly* to them both. By this provision the nerve is placed between fluid upon either side, and thus all danger of transmitted force affecting it is obviated, while the deep situation of the carotid and the close proximity of the transverse processes of the cervical vertebræ make the nerve secure from the danger of wounds of pointed instruments. It is almost an impossibility, therefore, for this nerve to become involved in any form of accident, without the large vessels of the neck being simultaneously injured and the patient sacrificed.

Even in the jugular foramen the nerve is *wrapped in the same sheath* as the *spinal accessory nerve*, and it is placed behind both the glosso-pharyngeal nerve and the jugular vein ; while, to reach the commencement of the common ca-

rotid artery, the nerve is placed in close relation to the internal carotid artery and the jugular vein.

As the nerves of either side reach the lower portion of the neck, each takes a different course. The *right nerve* passes between the subclavian artery and vein, then along the side of the trachea, then to the back of the root of the lung, then along the side of the œsophagus as two cords, then as a single cord along the back of that tube through the œsophageal opening of the diaphragm, and terminates in the solar and splenic plexuses, after giving off branches to the posterior surface of the stomach, and some filaments to the liver. The *left nerve* passes between the left common carotid and left subclavian arteries and behind the left innominate vein, then arches across the aorta and passes to the back of the root of the lung, then as two cords along the sides of the œsophagus, where it joins with its fellow to form the œsophageal plexus, then, as a single cord, in front of the œsophagus through the œsophageal opening of the diaphragm, when it supplies the anterior surface of the stomach and probably terminates in the hepatic plexus.

#### THE EFFECTS OF SECTION OF THE PNEUMOGASTRIC NERVE.

The effects of section of both of the pneumogastric trunks,<sup>1</sup> if made below the jugular ganglion, are most markedly exhibited in the larynx, the lungs, and the heart.

*Effects upon the Larynx.*—The larynx becomes impaired in its function, and the glottis remains partially closed by the vocal cords, whose abductor muscles are now paralyzed, thus impeding the free entrance of air into the lung; and, as a consequence of this, the respirations are, for a short time, hurried and difficult, although they soon become diminished in frequency.<sup>2</sup> The *inspiratory effort* becomes *unusually*

<sup>1</sup> Animals usually survive after one vagus nerve is divided, and present only a *hoarseness* of voice; an *increased frequency of respiration*, *emphysema*, or *pulmonary congestion* may be a sequel to the operation. Union of the divided nerve has been observed in numerous instances.

<sup>2</sup> Were it not for the *nerves of the skin*, and other *sensory nerves* which can transmit the feeling of pain, and which also possess the power of exciting respiratory efforts, section of both vagi ought, theoretically, to stop respiration at once.

*slow*, while expiration is remarkably rapid and sometimes audible; the intercostal spaces sink inward during the elevation of the ribs, showing that the lungs are not fully inflated with air, and death occurs in from one to six days, as the result of pulmonary consolidation. There are no symptoms accompanying the approach of death, except a gradual failure of respiration and a peculiar sluggishness,<sup>1</sup> which is characteristic and probably dependent upon carbonic-acid poisoning.

The immediate cause of death can undoubtedly be attributed to the altered condition of the lungs, which present a state of simple *vascular engorgement*, without any apparent inflammatory condition either of the lung or pleura. In very young animals, the division of the vagi is followed by almost immediate death, but this is attributable rather to paralysis of the glottis and the ensuing suffocation than to pulmonary congestion, which requires time for its development.

*Effects upon the Lungs.*—There have been many theories advanced to explain the effects of division of the pneumogastric nerves upon the lung tissue, and particularly to explain why such an operative procedure should be followed by excessive pulmonary hyperæmia, so as to cause the specific gravity of the lungs to exceed that of water. It seems to me that the theory, that the entrance of secretions or food into the lung through the paralyzed glottis (which can no longer spontaneously expel any foreign body) will explain the consolidation of the lung as a *direct result of irritation*, is not sustained either by the pathology of the pulmonary lesion or by experiments where a canula has been placed in the larynx to prevent this cause of irritation. Bernard has explained it on the ground that *traumatic emphysema* of the lung is developed from the labored inspiratory efforts made by the animal after the division of the vagi, thus creating a *mechanical hæmorrhage* which eventually consolidates the lung tissue. He sustains this theory by the fact that birds, whose lungs are fixed and immovable, and are therefore inexpandible, fail

<sup>1</sup> The *convulsions* which often accompany asphyxia are usually absent in these animals.

to present this condition when the vagi are divided, although death is produced.

To my mind, the most plausible explanation of the effects of this operation upon the lungs may be regarded as a purely mechanical one, dependent upon the *impeded entrance of air* through the larynx. During each inspiratory effort, the depression of the diaphragm and the elevation of the ribs tend to create a vacuum within the pleural and pericardial sacs, and thus favor the entrance of both air and blood into the thorax. So long as the entrance of either one remains unimpeded, the proper balance between the two is preserved, and neither too much air nor too much blood is sucked in with each inspiration; but, when the air is prevented from entering, an *excess of blood* flows into the lung with each inspiration, and, in the course of time, the lung is thus mechanically consolidated. Were the number of respirations not greatly decreased from the normal standard, the duration of life would probably be proportionally shortened, as the same effect would be produced in shorter time. The death of birds and some other animals, after section of the vagi, may possibly be explained on the ground of a too powerful impression upon the *respiratory center*

*Effects upon the Heart.*—In addition to the effects upon the lungs, division of the pneumogastric nerves is followed by a marked *alteration of the action of the heart*. The effects are somewhat similar to those which might result if the governor of a steam-engine were suddenly removed, and the piece of mechanism allowed to proceed without its controlling influence. Thus the heart increases slightly in the rapidity of its pulsations, and the amount of *cardiac pressure becomes slightly diminished*, when one of the nerves is severed; but, when both are divided, the respiratory symptoms far outweigh those of the heart, but its action is still accelerated and often irregular, since the inhibitory power of the nerves is destroyed.

*Effects upon the Digestive Tract.*—The *oesophageal branches* of the vagus are the *motor nerves*, which control the

peristaltic action of that tube (as is proven by the fact that division of the pneumogastric nerves of both sides causes complete paralysis), and also the means by which *sensation* is afforded to its mucous lining. In animals which have been subjected to division of the vagi, attempts to swallow food in any considerable quantities create a distention of the upper part of the œsophagus, and regurgitation by means of the mouth takes place without the food entering the stomach, as was proven by Bernard, who made a gastric fistula in a dog before dividing the pneumogastrics, in order to decide this point. From what source the motor fibers which control the movements of the œsophagus are derived by the pneumogastric nerve is still a matter of doubt; the root of the nerve itself seems to possess some influence upon it, thus showing that it can not be traced to the nerves which communicate with it below the jugular foramen.

The branches which are *distributed to the liver* by the pneumogastric nerves are probably, in some way, connected with the *glycogenic function* of that organ, since division of these nerves causes the liver to yield no traces of sugar after the animal succumbs, which is contrary to the result obtained after death in animals which have these nerves intact. When the nerves are divided in the living animal, and the end nearest to the brain is galvanized, an increase of sugar in the blood is thus artificially produced at any time during the life of the animal, and traces of the same may also be found in the urine. A similar hyper-secretion of sugar by the liver may be also noticed after the inhalation of irritating vapors or anæsthetics, probably through the influence of the vagi.

The *gastric branches* of the pneumogastrics show a marked alteration in their power of control over that organ when the main nerve trunks are divided. The mucous lining of the stomach becomes at once pale, and the secretion of gastric juice apparently arrested, although a slight amount of secretion may return in a few days if the animal survive. The

<sup>1</sup> Physiologists are not agreed as to the seat of the reflex act of vomiting which follows division of the vagi.



sensations of *hunger* and *thirst* remain, but are sensibly diminished. *Absorption* by the stomach is evidently delayed, but not arrested, as has been proven by the introduction of poisons into that organ.

The *intestinal branches* of the vagi unquestionably control the secretions of the canal, and section of the nerves has been shown to prevent the action of the most powerful cathartics, even in fatal doses, when administered immediately before the vagi were divided. It is still a question whether the pneumogastric nerves influence the secretions of the intestinal canal directly, or through the sympathetic system by means of communicating filaments.

If the latter be the case, those filaments of communication which control the stomach and œsophagus must be sought for high up in the cervical region.

#### CLINICAL POINTS PERTAINING TO THE PNEUMOGASTRIC NERVE.

The physiological function of the separate branches of the pneumogastric, as mentioned in preceding pages, will assist you in appreciating the various manifestations of diseased conditions of the main trunk of the vagus, or of its individual branches. You can understand, from what has previously been said, that the effect of degeneration, section, or pressure upon this important nerve must vary with the seat of the lesion; since those branches given off above the point where the nerve is impaired will manifest their usual powers, while those given off below that point will show symptoms of partial or complete paralysis. We can, therefore, study the effects of impairment of the pneumogastric nerve by considering the individual branches in their order from above downward, and recording the special types of disease which are liable to create symptoms referable to each branch.

The *pharyngeal branch* contains both motor and sensory fibers; hence injury to its structure will create both paralysis and anæsthesia, while simple irritation of its fibers will tend to create contraction or spasm of certain muscles to which its motor fibers are distributed. We thus see, in attacks of

hysteria, the so-called "*globus hystericus*," a spasmodic affection of the pharynx, due to some irritation of the pneumogastric trunk or of the pharyngeal branches. We also occasionally meet true paralysis of this branch; in which case, the act of deglutition is greatly impaired, and, if the disease is bilateral, swallowing is rendered almost an impossibility.

The *superior laryngeal branch*, whose function is to supply the mucous lining of the larynx with sensibility,<sup>1</sup> becomes, under irritation, the cause of "spasm of the glottis" and of "whooping-cough." The former condition, called also "*stridulous laryngitis*" and "Kopp's asthma," is a disease peculiar to children, which tends toward asphyxia, but which is rarely if ever fatal. It usually occurs during the night, and seems to affect children who have been in apparent health. It is most common during the cold months; is sometimes associated with convulsions; and is characterized by a sibilant character to the respiration, pallor, or turgidity of the countenance, and a peculiar retraction of the head. In rare cases, this condition is met with in the adult, during attacks of hysteria. It seems to be dependent, in children, upon dentition, digestive irritation, anæmia, rickets, etc.

The experiments of Rosenthal seem to point to the superior laryngeal nerve as the exciting cause of the *convulsive cough* of "*pertussis*," and also of that analogous cough often met with in hysterical subjects, since artificial stimulation of the nerve produced, with this observer, similar results. Whether the irritation of the nerve proceeds from the catarrhal inflammation which exists in the respiratory passages, or irritation of some spinal or cerebral center, is not yet well determined.

The *recurrent laryngeal branch* is of great clinical importance, since its peculiar course often makes it a guide to aneurism of the large blood-vessels by the peculiar symptoms which

<sup>1</sup> See page 232 of this volume.

<sup>2</sup> The reader is referred to "A Treatise on Surgical Diagnosis" (New York, 1881), by the author, for all the points of diagnosis of this type of disease.

it creates within the larynx.<sup>2</sup> The so-called "brassy cough" is, by some surgeons, considered as pathognomonic of pressure upon or irritation of this branch, and strongly indicative of aneurism of the subclavian, carotids, the *arteria innominata*, or of the left side of the arch of the aorta.

This branch may be affected by central causes, as well as by peripheral pressure or irritation. As examples of the central causes of impairment of this nerve may be mentioned those cases of apoplexy, cerebral tumors, hysteria, diphtheria, typhoid fever, and reflex irritation from diseases of the uterus or genitals, where the larynx is markedly affected. The peripheral causes which more commonly affect the recurrent laryngeal nerve, include catarrhal, tuberculous, and syphilitic inflammations of the larynx, traumatism, the pressure of growing tumors, as aneurism, goître, sarcoma, cancer, lymphatic tumors, tumors of the œsophagus, etc.

The experiments of Bernard, Bischoff, and Waller<sup>1</sup> (given in some detail in previous pages) will help to explain how a lesion, which excites laryngeal symptoms, may occasionally be situated away from the line of the pneumogastric nerve, since the spinal accessory nerve may be the seat of irritation or degeneration. They will also help to explain why the effects of bilateral paralysis of the recurrent branch do not produce dyspnœa, at the same time that it causes the voice to be lost; why the vocal cords are seen to be cadaveric and relaxed; and why the act of coughing and the expulsion of laryngeal mucus is no longer possible.

The *pulmonary branches* of the nerve are unquestionably concerned, to some extent, in the conditions associated with bronchial spasm, since asthma may be developed by mental influences acting upon the origin of the vagus. Moreover, we often see severe types of this disease produced by the pressure of thoracic tumors upon the pneumogastric; by the inhalation of substances possessing slight irritative qualities; by uterine irritation, acting as a cause of reflex action through the pneumogastric nerve; and by fright, shock, exposure,

<sup>1</sup> See page 264.

etc. The symptoms of asthma are too well known to be here repeated.

We have one other condition developed as the effect of pressure upon, or destruction of, the vagus, viz., paralysis of the pulmonary branches and the consequent paralytic condition of the blood-vessels of the lung. It is to this condition that some authors attempt to refer the serous infiltration into the parenchyma of the lung which follows section of this nerve; and we know, clinically, that a similar condition is sometimes produced by compression of the nerve by a tuberculous or cancerous degeneration of the lymphatic glands, especially those situated near to the bifurcation of the trachea, and by aneurism of the thoracic vessels. The same condition has been observed after injuries to the organs of the chest, and from the section of some of the branches of the vagus, during an attempt to ligate the subclavian in its first portion or the *arteria innominata*.

The *cardiac branches* seem to exert a more marked effect upon the heart when exposed to irritation than when actually destroyed by degeneration or section. An artificial "angina pectoris" may be produced by pressure upon the vagus in the neck (as performed by Czermak upon himself), and the heart's action may thus be almost entirely arrested. It may be stated, I think, that angina pectoris, sometimes called "cardiac neuralgia,"<sup>2</sup> is one of those neuroses of the heart which depend, to a large extent, upon changes of a secondary character in the terminal filaments of the vagus or the cardiac ganglia.

The symptoms of this affection are very distressing to the patient, and often fatal. The attack usually begins with a sense of extreme constriction within the chest, which is followed by radiating pains of a very intense character, which

<sup>1</sup> For the different theories advanced to explain this effect, the reader is referred to page 250 of this volume.

<sup>2</sup> I prefer to limit the term "angina pectoris" to those cases only where the exciting causes have resulted in *defective heart power*, and to apply the term "cardiac neuralgia" to those cases where the power of the heart is normal. This I consider to be the true pathological distinction.

shoot down the arm or into the neck. The paroxysms produce the most rapid exhaustion, and are not usually long continued. The various pathological conditions found to exist in this affection include an ossified state of the coronary vessels (thus interfering with the nutrition of the heart walls); cardiac hypertrophy (which is usually of that form called compensatory, since the cavities of the heart are generally dilated); fatty degeneration of the heart; valvular lesions (with their secondary changes in the size of the cavities); and aneurism within the pericardial sac.

The *gastric branches* of the vagus are associated with the conditions of gastrodynia (cardialgia), boulimia, polydipsia, nervous vomiting, and disorders of the secretory follicles of the organ, as well as its power of absorption. Gastrodynia is a paroxysmal attack of neuralgia of the sensory fibers of the stomach. It produces pain of the most intense character, which often compels the strongest subjects to writhe in agony, and to become bathed in a profuse perspiration, irrespective of the temperature of the atmosphere. The face becomes bloodless, the limbs cold, the abdomen retracted, and the pulse small and irregular. The attacks are usually of short duration, and are most frequently terminated by eructations and vomiting. This disease is met with in hysterical and anæmic subjects, in the course of diseases of the uterus and ovaries, in spinal and cerebral affections, and in certain dyscrasiæ.

An abnormal condition of hunger, which is appeased by small quantities of food, but which returns at frequent intervals with an uncontrollable desire, often interrupting the hours of sleep, is produced by some disordered condition of the vagus, and is called "*boulimia*." This affection is met with in hysterical patients, after prolonged fevers, in severe forms of nervous debility, in syphilis, insanity, and diabetes.

By "*polydipsia*" we mean an intolerable thirst, dependent upon an hyperæsthesia of the nerve fibers of the mucous membrane of the stomach, pharynx, and mouth, and prob-

ably due to some abnormal state of the pneumogastric nerve. It is often an associate symptom with boulimia, and is produced by the same general causes.

The state of "*polyphagia*" signifies a desire for excessive quantities of food. It is supposed to exist when the nerve fibers of the vagus distributed to the stomach are in a state of anæsthesia, in contrast to the condition producing the two previous diseases. It has been found to accompany softening of the medulla oblongata, compression of the roots of the vagus by an aneurismal tumor of the vertebral artery, atrophy of the vagi, neuromata of the vagi, and the morbid states of epilepsy, insanity, and hysteria.

The *nervous vomiting* which is clinically observed in connection with pregnancy, chlorosis, hysteria, digestive disturbances, and gastrodynia, is not to be confounded with that of local diseases of the stomach or of the alimentary canal, since the symptom depends, purely and exclusively, upon some abnormal condition of the nerves, rather than upon pathological changes in the stomach or intestine.

True paralysis of the gastric branches of the vagus must, of necessity, arrest the peristaltic movement of that organ, and thus tend to favor the retention of food within its cavity. This may be the explanation of the enormous enlargement of the stomach found after chronic inflammatory processes of that organ, and also as a sequel to cholera, typhoid fever, and some other blood poisons. The stomach becomes enlarged in these conditions mainly by the weight of the retained food and the pressure of the gases formed by its decomposition.

The *intestinal* and *hepatic branches* of the vagus are not well understood in their clinical phenomena, but the effects of section of the pneumogastric seem to point to some controlling influence of these fibers over the glycogenic function of the liver and the secretion of the intestinal juices. The effect of diseases of the peritonæum, or of the abdominal viscera, upon the heart and respiration, is to be explained either as the direct result of irritation of these fibers, or as a

reflex act through the sympathetic nerve upon the cardiac and respiratory centers, thus in turn affecting the heart and lungs through the vagus.

#### THE SPINAL ACCESSORY, OR ELEVENTH CRANIAL NERVE.

This nerve has a very extensive origin, since it derives its fibers not only from the medulla oblongata, but also from the cervical portion of the spinal cord. The fibers which arise from the medulla compose what is called the "*bulbar portion*," in contrast to those which arise from the cervical region of the spinal cord, to which the name of "*spinal portion*" is sometimes given. Such a distinction has an importance, distinct from merely indicating the point of origin of the fibers composing the two portions of the nerve, as the *functions* of the two are different.

If we trace the filaments of origin of the bulbar portion of the nerve, we can perceive that the fibers arise from the *lateral columns* of the medulla oblongata (its motor tract) and escape from its lower portion, beneath the fibers of the pneumogastric nerve. The spinal portion of the nerve can be traced between the anterior and the posterior roots of the first five cervical nerves, arising from between the roots of each nerve by a *pair* of filaments, with the exception of the last two, where the filament going to form the spinal accessory nerve is usually a single one. These several fibers unite as the nerve passes upward toward the cranium, thus causing the spinal portion of the nerve to gradually increase in size. In the cranium, the two parts join to form one nerve, which then escapes from the *jugular foramen*, in company with the pneumogastric and glosso-pharyngeal nerves and the jugular vein. The inferior meningeal artery enters the cavity of the cranium through this foramen, and therefore bears a relation to the nerves and vein.

The spinal accessory nerve receives filaments of communication with other nerves, even before it escapes from the cavity of the cranium, since the spinal portion, on its way

upward to unite with the bulbar portion, is joined by filaments derived from the two upper cervical nerves while in the spinal canal.

After the nerve has emerged from the jugular foramen, it gives off a large branch to the pneumogastric nerve, and occasionally receives a filament from the pneumogastric in return ;

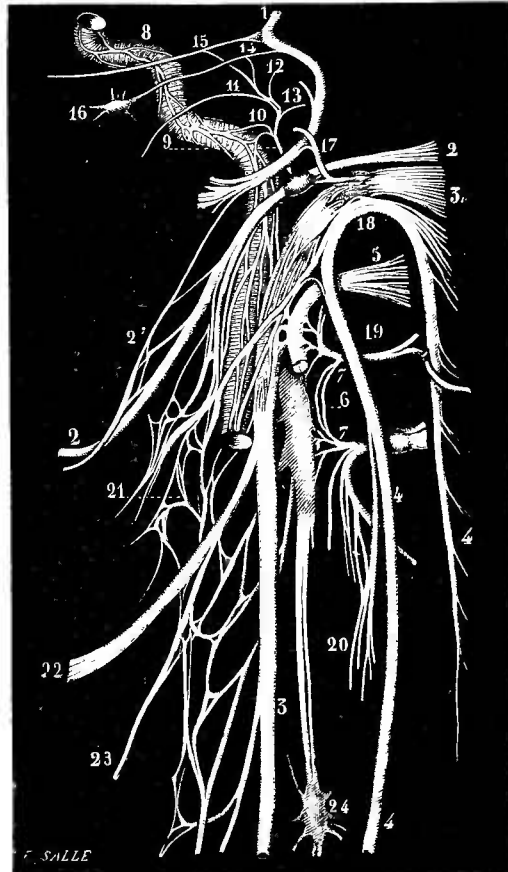

FIG. 94.—*Spinal accessory nerve.* (Hirschfeld.)

- 1, trunk of the facial nerve ; 2, 2, glosso-pharyngeal nerve ; 3, 3, pneumogastric ; 4, 4, 4, trunk of the spinal accessory ; 5, sublingual nerve ; 6, superior cervical ganglion ; 7, 7, anastomosis of the first two cervical nerves ; 8, carotid branch of the sympathetic ; 9, 10, 11, 12, 13, branches of the glosso-pharyngeal ; 14, 15, branches of the facial ; 16, otic ganglion ; 17, auricular branch of the pneumogastric ; 18, anastomosing branch from the spinal accessory to the pneumogastric ; 19, anastomosis of the first pair of cervical nerves with the sublingual ; 20, anastomosis of the spinal accessory with the second pair of cervical nerves ; 21, pharyngeal plexus ; 22, superior laryngeal nerve ; 23, external laryngeal nerve ; 24, middle cervical ganglion.

while, in its course down the neck, it receives filaments of communication from the second, third, and fourth cervical nerves, in case these nerves do not communicate with the spinal portion within the spinal canal.

After the nerve has sent its upper filament to the pneumo-



gastric, at the jugular foramen, it may usually be perceived to divide into two branches—an internal and an external; the former of which anastomoses directly with the trunk of the pneumogastric nerve, while the latter, called the “muscular branch,” pierces the back part of the upper third of the sternomastoid muscle, and terminates on the anterior surface of the trapezius. The first, sometimes called the “anastomotic

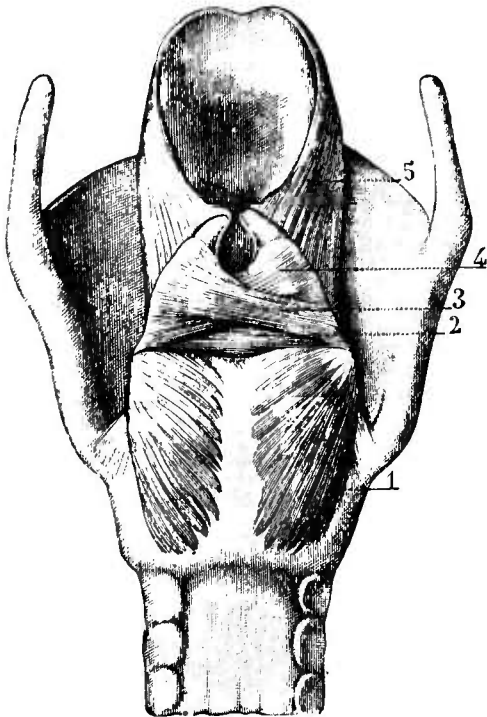

FIG. 95.—*Posterior view of the muscles of the larynx.* (Sappey.)

FIG. 95.—1, posterior crico-arytenoid muscle; 2, 3, 4, different fasciculi of the arytenoid muscle; 5, aryteno-epiglottidean muscle.

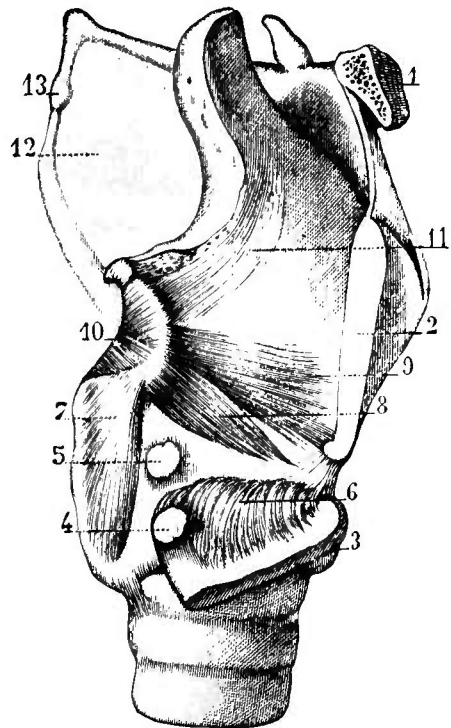

FIG. 96.—*Lateral view of the muscles of the larynx.* (Sappey.)

FIG. 96.—1, body of the hyoid bone; 2, vertical section of the thyroid cartilage; 3, horizontal section of the thyroid cartilage turned downward to show the deep attachment of the crico-thyroid muscle; 4, facet of articulation of the small cornu of the thyroid cartilage with the cricoid cartilage; 5, facet on the cricoid cartilage; 6, superior attachment of the crico-thyroid muscle; 7, posterior crico-arytenoid muscle; 8, 10, arytenoid muscle; 9, thyro-arytenoid muscle; 11, aryteno-epiglottidean muscle; 12, middle thyro-hyoid ligament; 13, lateral thyro-hyoid ligament.

branch,” is now known to be the nerve which *supplies the muscles of the larynx*, with the exception of the crico-thyroid muscle,<sup>1</sup> since physiological experiment confirms this distribution.

<sup>1</sup> The *arytenoid muscle* of the larynx is supplied by both the superior and recurrent laryngeal nerves, the latter of which carry most of the spinal accessory fibers, as is shown in Fig. 91 of this volume. It is also important to remember that the investiga-

The second branch communicates with the second and third cervical nerves, before it pierces the sterno-mastoid muscle, and its filaments undoubtedly furnish *motor power* to that muscle and also to the trapezius. It is proven by ex-

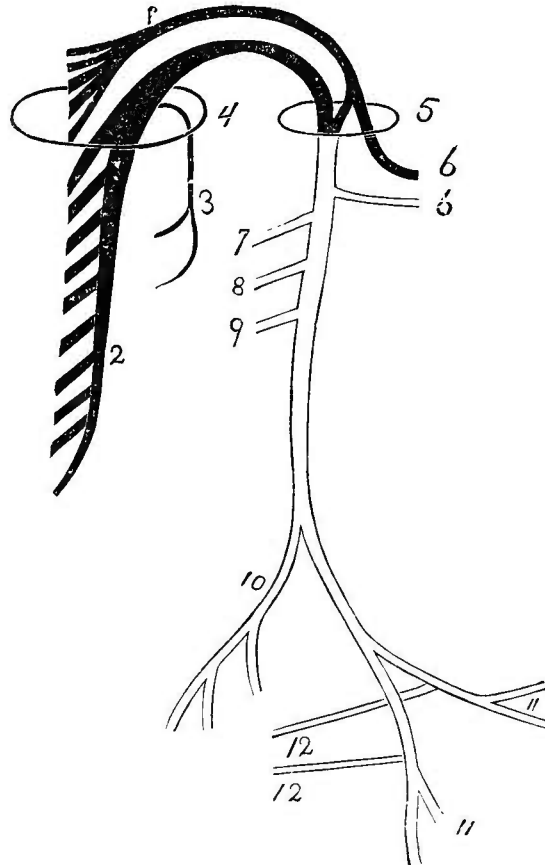

FIG. 97.—A diagram of the spinal accessory nerve.

- 1, the accessory portion of the nerve arising from the *medulla oblongata*; 2, the *spinal portion* of the nerve arising from the *spinal cord* (cervical region); 3, a filament arising from the *first and second cervical nerves* and joining the *spinal portion* of the spinal accessory nerve, before passing through the *foramen magnum*; 4, the *foramen magnum*, showing the *spinal portion* of the nerve entering the *cranium*; 5, the *jugular foramen*, showing the *spinal and accessory portions* of the nerve communicating as they pass through it; 6, the *large filament* going to the *pneumogastric* to supply the *muscles of the larynx*, and the *small filament* returning to the trunk of the spinal accessory nerve; 7, 8, 9, filaments of communication between the spinal accessory nerve and the *third, fourth, and fifth cervical nerves*; 10, muscular branches to the *sterno-cleido-mastoid muscle*; 11, muscular branches to the *trapezius muscle*; 12, communicating filaments from the *cervical plexus* of nerves.

periment, however, that section of the spinal accessory nerve does not produce total paralysis of these muscles; and, from

tions of Bernard and Bischoff have demonstrated the existence of other motor fibers to the larynx, irrespective of those of the spinal accessory, which seem to control the *automatic respiratory movements* of the glottis.

this fact, it is conclusively proved that some other sources of nerve supply to these muscles exist, besides the spinal accessory filaments.

A TABLE OF THE BRANCHES OF THE SPINAL ACCESSORY NERVE.<sup>1</sup>

THE SPINAL AC- CESSORY, OR 11TH CRANI- AL NERVE.	{	ACCESSORY OR BULBAR PORTION (by means of the sheath of the <i>pneumogastric nerve</i> ).	{	Branches to the <i>pharyngeal plexus</i> , Branches to the <i>superior laryngeal</i> nerve (and thus to the <i>depressor nerve of the heart</i> ), Branches to the <i>recurrent laryngeal</i> nerve (thus supplying the muscles of phonation).
		SPINAL PORTION.		Branch to the <i>sterno-mastoid</i> muscle, Branch to the <i>trapezius</i> muscle.
				COMMUNICATING BRANCHES TO { 1st cervical nerve, 2d cervical nerve, 3d cervical nerve, 4th cervical nerve.

FUNCTIONS OF THE SPINAL ACCESSORY NERVE AND THE EFFECTS OF SECTION.

The experiments of Bernard, to whose ingenuity much of our present knowledge of the function of the bulbar and spinal portions of this nerve is due, seem to warrant the conclusion that the bulbar or medullary part of the nerve possesses a direct control upon the *muscles of the pharynx and larynx*, but no effect whatever upon the *sterno-mastoid* and *trapezius* muscles. Galvanism of the spinal portion of the nerve seems to have a directly opposite effect, since the muscles of the pharynx and larynx were unaffected, and the two muscles of the neck to which the nerve is distributed were thrown into movement. It also appears from the results of this great experimenter that the nerve is essentially *motor in its function* at its origin from the medulla and spinal cord, but that it gains sensory fibers after it leaves the cavity of the cranium, by means

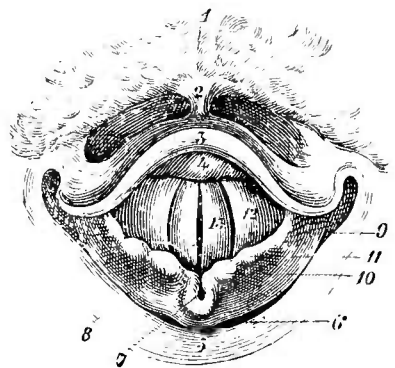

FIG. 98.—Glottis seen with the laryngoscope during the emission of high-pitched sounds. (Le Bon.)  
1, 2, base of the tongue; 3, 4, epiglottis; 5, 6, pharynx; 7, arytenoid cartilages; 8, opening between the true vocal cords; 9, aryteno-epiglottidean folds; 10, cartilage of Santorini; 11, cuneiform cartilage; 12, superior vocal cords; 13, inferior vocal cords.

<sup>1</sup> Modified from a table in the "Essentials of Anatomy" (Darling and Ranney). Putnam's Sons, New York, 1880.

of certain filaments of communication derived from the cervical nerves and the pneumogastric. This fact probably explains why two points of communication should exist between the spinal accessory and the pneumogastric nerves; since, at one point, the sensory filaments of the pneumogastric were given to the spinal accessory, while, at the other point, the motor filaments of the spinal accessory were sent to the pneumogastric sheath for protection, until they could be distributed to the muscles of the larynx.

Bernard and Bischoff have probably done more to clear up the disputed relation of the spinal accessory nerve to the muscles of the larynx, and thus to the acts of phonation and respiration,<sup>1</sup> than any of the later investigators upon the physiology of the nervous system. When the spinal accessory nerve is drawn out from the medulla and spinal cord of an animal, as can be done with little if any injury to the nerve, if the requisite care and skill be employed, the effect is at once *manifested in the voice*, which becomes hoarse and unnatural, when the nerve of one side only is extracted, but entirely extinct when both nerves are thus treated. The *act of deglutition* is also somewhat affected, and the trapezius and sternomastoid muscles are paralyzed, but only to a partial extent.

An interesting relation of the spinal accessory nerve to the *action of the heart* seems to be well shown by the experiments of Waller, who first called the attention of the profession to the fact that extirpation of the roots of the spinal accessory nerve produced a modification in the effects of galvanism of the trunk of the pneumogastric nerve, provided that sufficient time (some two weeks) was allowed after the operation for the irritation so produced to subside. As has been mentioned in the previous lecture upon the pneumogastric nerve,<sup>2</sup> galvanism of that nerve with a powerful current will arrest the action of the heart in a state of health, even if

<sup>1</sup> The nerves concerned in the two acts of *phonation* and *respiration* are not to be confounded, since it is probable that the pneumogastric nerve sends filaments of a motor character to the larynx, which are independent of the spinal accessory nerve, and which probably preside over the *respiratory movements* of the glottis, while the spinal accessory nerve controls *phonation*.

<sup>2</sup> See page 236 of this volume.

applied on one side of the body. Now, Waller found that after the spinal accessory nerve of one side had been drawn out, and the animal allowed to recover the shock of the operation, and to wait some days for all signs of irritation to subside, galvanism of the pneumogastric nerve of the same side no longer seemed to affect the action of the heart. The *de-*

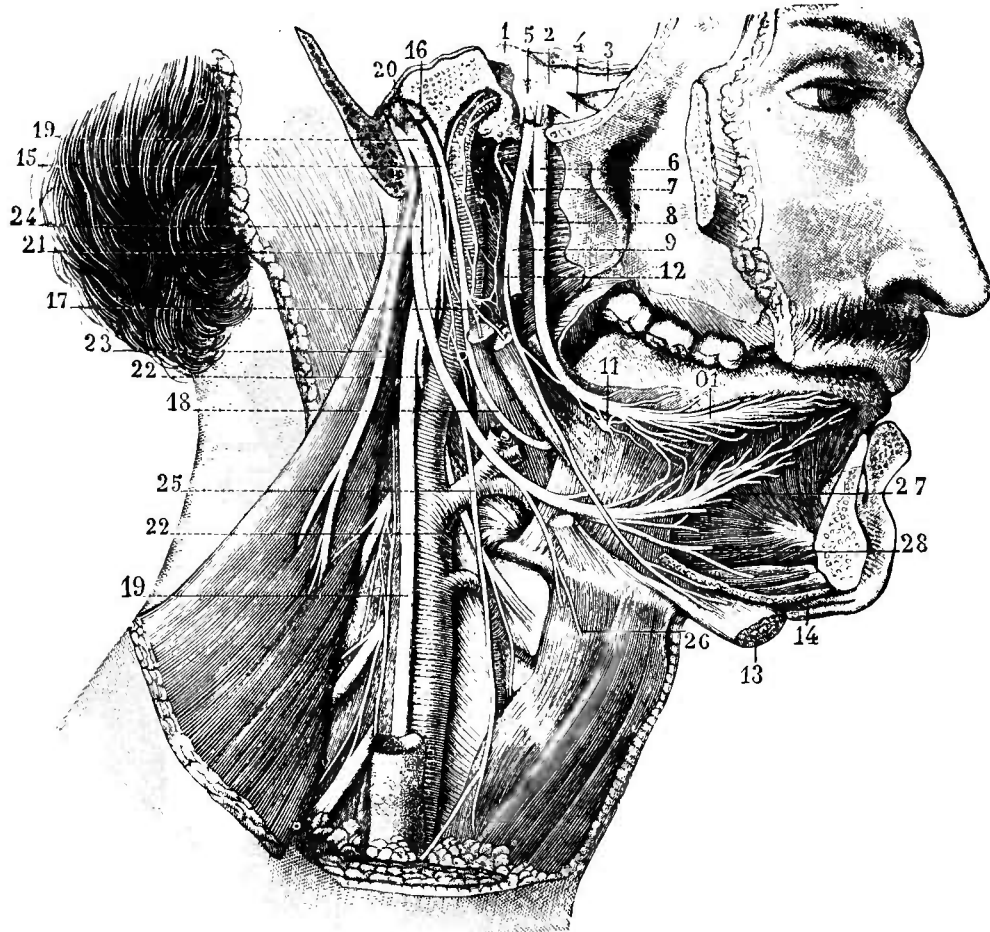

FIG. 99.—*The spinal accessory nerve.* (Sappey.)

1, large root of the fifth nerve; 2, ganglion of Gasser; 3, ophthalmic division of the fifth; 4, superior maxillary division; 5, inferior maxillary division; 6, 10, *lingual branch of the fifth, containing the filaments of the chorda tympani*; 7, branch from the sublingual to the lingual branch of the fifth; 8, *chorda tympani*; 9, inferior dental nerve; 10, terminal branches of the gustatory nerve; 11, submaxillary ganglion; 12, mylo-hyoid branch of the inferior dental nerve; 13, anterior belly of the digastric muscle; 14, section of the mylo-hyoid muscle; 15, 18, *glosso-pharyngeal nerve*; 16, *ganglion of Andersch*; 17, *branches from the glosso-pharyngeal to the stylo-glossus and the stylo-pharyngeus muscles*; 19, 19, pneumogastric; 20, 21, ganglia of the pneumogastric; 22, 22, superior laryngeal nerve; 23, *spinal accessory*; 24, 25, 26, 27, 28, sublingual nerve and branches.

*pressor nerve of the heart*, which arises from both the superior laryngeal and pneumogastric nerves, since it has two heads, must, therefore, be in some way connected with the

spinal accessory nerve. It may, therefore, be stated with as much positiveness as any physiological point can be laid down, that the communicating filament given off by the spinal accessory nerve to the pneumogastric controls the heart fibers as well as the muscles of phonation.

The distribution of the spinal accessory nerve to only two of the muscles of the neck—the *sterno-mastoid* and the *trapezius*—would naturally suggest, to the inquiring mind, why these muscles should have been singled out as particularly associated with this nerve. Throughout this entire course of lectures I have frequently called your attention to the fact, which can not be too often repeated, that the distribution of nerves to muscles always denotes a *purpose* on the part of Nature, and a *similarity of function* in the muscles supplied by the same nerve, if we will but search for it. Now, we have already seen that the spinal accessory nerve is chiefly destined to control the *muscles of phonation*, since other nerve fibers go to the larynx, which assist in moving the vocal cords during the opening of the glottis, previous to each inspiratory act; therefore, the spinal accessory nerve can not be said to be directly concerned with the respiratory function. If we will study the attitude assumed by a vocalist in the *act of singing* (and it is in the singing act, rather than that of talking, that we see the mechanism of phonation best displayed, since it requires more of a muscular effort than the simple articulation of words), we shall perceive that the sterno-mastoid and the trapezius muscles are important factors *in the production of voice*, as they tend to fix the shoulders (that is, the scapulæ and the clavicles) and also the upper part of the sternum. In all vocal efforts, the first act necessary to its performance is a full inspiratory effort, which can only be performed by first calling into play those muscles which render the upper portion of the chest and the bones of the shoulder immovable, so as to have a *fixed point* from which the true inspiratory muscles can act upon the ribs and their cartilages; and it can, therefore, be understood why these muscles should properly be placed under the control of

that nerve which also controls the muscles which regulate the position and tension of the vocal cords during the expiratory effort, and thus causes the proper vibrations of these cords, and regulates the note which follows.

In animals, where the muscular branch of the spinal accessory nerve has been severed, a difficulty in progression has been observed by Bernard, and a peculiar *shortness of breath* after violent exercise. The difficulty in locomotion is not present in man, on account of certain anatomical peculiarities which render the arm unnecessary for progressive motion, which is not the case with quadrupeds; but the shortness of breath which has been observed would probably exist in a man after violent exercise, or when any demand for an excessively full inspiratory effort occurred, if the trapezius or the sterno-mastoid muscles were paralyzed.

A theory advanced by Hilton,<sup>1</sup> as explanatory of the peculiarity of the course of the spinal accessory nerve, deserves mention, since it tends possibly to explain not only the irregular course of the nerve, but also the object of the *communication* of the *sub-occipital* with the *spinal accessory nerves* within the spinal canal. According to this author, the spinal portion of this nerve becomes joined to the sub-occipital before it enters the cranium, and, since that nerve is almost exclusively a motor nerve, what object could the spinal accessory, which is itself a motor nerve, have in sending additional filaments to the sub-occipital, unless it was for the purpose of sending fibers to the inferior oblique, the two posterior recti, and the complexus muscles of the neck? Now, when a motor impulse is sent out by means of the spinal accessory nerve, the effects reach those muscles first which are nearest to its place of origin; hence, the muscles of the sub-occipital region are caused to contract before the trapezius or the sterno-mastoid muscles, and, by so doing, the head is drawn backward before the latter muscles act, thus greatly assisting them to raise the thorax, as well as in rendering the head a fixed point during the inspiratory act.

<sup>1</sup> "Rest and Pain," London, 1872.

## CLINICAL POINTS PERTAINING TO THE SPINAL ACCESSORY NERVE.

Like all motor nerves, the spinal accessory may exhibit the condition of spasm or paralysis in the parts supplied by it; if subjected to some source of irritation, as in the first instance, or to some lesion which destroys its power of conduction, as in the latter. The spasm dependent upon irritation of this special nerve seems to be confined exclusively to the sterno-mastoid and trapezius muscles. They may be unilateral or bilateral, and the muscular contractions may be either of the tonic or clonic variety.

Both of these types of spasm are met with in connection with reflex irritation originating in some of the remote viscera; hence they are not infrequent in severe types of hysterical affections. They may also be produced by diseases affecting the upper cervical vertebræ, by certain forced movements of the head, by exposure to cold and wet, and by local diseases of the brain and spinal cord. When we consider the intimate connection which this nerve has with the spinal cord, as well as the medulla oblongata and brain, we can better appreciate the difficulty which often arises in locating the exact seat of the irritation which is producing these spasmodic movements. There are reported cases to prove that tumors of the brain or spinal cord, softening of either of these regions, meningeal inflammation of the brain or cord, injuries to the skull or upper cervical vertebræ, and caries, periostitis, and tumors of the upper cervical vertebræ, may all be exciting causes of this spasmodic action.

*Tonic Spasm of the Sterno-mastoid and Trapezius Muscles.*—When the *sterno-mastoid muscle* is the seat of *tonic spasm*, the head is so drawn that the ear approaches the clavicle, the occiput the tip of the shoulder, and the chin is so rotated that it points toward the opposite side. This condition is of longer or shorter duration, and often shows a marked tendency to become a permanent contracture. During the early paroxysms, the patient can not rectify the displacement of the head by his own voluntary efforts, and pas-



sive motion is strongly resisted. The early periods of the paroxysm are often accompanied by sharp pains. When the disease has become chronic, the deformity of the neck is associated with a *permanent curvature of the cervical vertebræ* and a corresponding curve of a compensatory character in the dorsal and lumbar regions. A rare case of bilateral tonic spasm of the sterno-mastoid muscles is reported by Duchenne, in which the chin was approximated to the breast.

The *trapezius muscle* may also be the seat of *tonic spasm*. In this case, the head is inclined toward the affected side, the occiput is drawn toward the shoulder, the shoulder itself is raised, and the scapula is drawn inward. The chin is not rotated toward the unaffected side, as in the case of the sterno-mastoid muscle. All attempts to bring the head into its proper relation to the trunk create a rigidity and sensitiveness over the region of the trapezius.

*Clonic Spasm of the Sterno-mastoid and Trapezius Muscles.*—This variety of spasm, which is dependent upon the same general list of causes as the tonic form, may be unilateral or bilateral. Either of the muscles supplied by the spinal accessory may be affected alone, or the sterno-mastoid and trapezius may contract alternately. If the spasm be confined to one muscle and of the unilateral type, the deflection of the head will be the same as in the tonic spasm, except that the duration of the contraction will be for a shorter period, and of a convulsive variety; while, if the two muscles of one side contract alternately, the attitude of the head will be constantly changing from the condition due to contraction of the one to that produced by the other. When the sterno-mastoid muscles of both sides act simultaneously in a spasmodic contraction, a peculiar “nodding movement” is perceived. You can understand how all forms of combinations can be made between the two muscles of either side, and a proportionate variety of spasmodic attitudes will be the result. All of these contractions occur, for the most part, in *paroxysms*, often lasting for a day, and not infrequently coming on with such violence and frightful vehe-

mence that the head is tossed to and fro with great force, making the life of the patient miserable. In some instances, the spasm is almost continuous. Sleep, however, usually brings rest, though this is often prevented or delayed.

In *unilateral clonic spasm* of the sterno-mastoid muscle, the adjacent muscles of the face, jaw, and arm are occasionally thrown into simultaneous action. The scaleni muscles are also sometimes brought into active play, and their forcible compression of the brachial plexus of nerve and the veins of the neck has been known to result in stiffness, anæsthesia, and œdema of the arm, after such an attack had subsided.

The nodding movement produced by the *bilateral clonic spasm* of the sterno-mastoid muscles is sometimes called the "salaam convulsion of Newnham." It is rarely seen in adults, but in children it is not infrequent. Should it occur during dentition, the spasm may be associated with convulsive movements of the facial muscles, with strabismus, and even with general convulsions and a loss of consciousness. Bilateral spasm of the muscles supplied by the spinal accessory nerve has been known to terminate in epilepsy, insanity, and paralysis; and, when the various causes of the condition are reviewed, this will appear but the natural sequence of the further progress of some of the diseases mentioned. Should reflex irritation, as in dentition, worms, hysteria, etc., exist, or the spasm be dependent upon rheumatic origin, exposure to cold or dampness, traumatism, caries, and other curable conditions, the results will be arrested when the exciting cause has been removed.

*Paralysis of the Sterno-mastoid and Trapezius Muscles.*—These muscles may be affected with a total arrest of their nerve power by lesions of the motor columns of the spinal cord, resulting in progressive muscular atrophy; by fracture of the cervical vertebræ; diseases of the vertebræ near the skull and also of the cranial bones; injuries to the nerve, such as cuts, stabs, gunshot wounds of the neck; and compression of the nerve from peripheral causes, as in the

case of tumors of the neck, swelling of the lymphatic glands of the neck, abscesses, neuromata, etc.

The sterno-mastoid or the trapezius may be paralyzed independently of the other, or they may both be affected simultaneously, according as the cause affects the entire nerve or only some individual branch. The paralysis may, in some instances, be bilateral, provided the exciting cause be central and involve the parts in the median line, or so extensive as to press upon the trunks of both spinal accessory nerves. A case of bilateral paralysis following progressive muscular atrophy of the muscles of the neck is reported by Rosenthal, where the patient was obliged to support the head by a collar made of pasteboard ; but this was rather the consequence of the general atrophy of the muscles than the effect of the paralysis of the two muscles supplied by the spinal accessory.

In *unilateral paralysis* of the *sterno-mastoid muscle*, the voluntary rotation of the head toward the unaffected side is performed with difficulty ; the chin is turned toward the affected side, on account of the unopposed action of the healthy muscle ; the chin is also slightly elevated, and the paralyzed muscle does not stand out with equal prominence with its fellow, when the chin is supported by the hand of the physician, and direction is given to the patient to try and depress the chin toward the chest. If this unilateral paralysis be long continued, the contracture of the healthy muscles produces the condition of "torticollis."

When a *bilateral paralysis* of the *sterno-mastoid muscles* is developed, the head is held straight, and its rotation, especially with the chin elevated, is performed with extreme difficulty. The neck appears thin, and the lateral aspect of that region is markedly flattened, since the normal prominence of the sterno-mastoid muscle is wanting. The same test, as mentioned above, when the chin is supported by the hand of the physician, shows a great loss of power in attempting to flex the head upon the chest.

The effects of *unilateral paralysis* of the *trapezius muscle* are most marked in the region of the scapula. This bone

appears to be drawn downward and forward ; its inferior angle lies closer to the vertebral column than that of its fellow, and its upper part is more widely separated from the vertebræ. The clavicle is caused to stand off from the chest, on account of the acromion being drawn downward and forward by the weight of the upper extremity and the pectoral and the levator anguli scapulæ muscles ; hence, the supra-clavicular fossa is apparently enlarged, in comparison with the healthy side. It is to be remembered, however, by you that the trapezius, unlike many others in the body, often manifests paralysis in *portions* of the muscle ; so that the symptoms of this type of unilateral paralysis admit of many modifications, in accordance with the extent and limits of the disease. Thus, the position of the scapula will vary with the paralysis of the upper, middle, or lower fibers of the muscle ; the power of elevation of the arm will be greatly impaired if the upper fibers are paralyzed ; while the approximation of the scapula to the vertebral column is very much impaired when the middle fibers are alone involved.

When the *trapezei muscles* are affected with *bilateral paralysis*, in addition to the symptoms described, which will now be perceived upon both sides, the *back will appear broader and more arched*, since the scapulæ are lowered and drawn outward, while they are also more prominent. Some difficulty may also be experienced in maintaining the head in an upright position, since it naturally tends to sink toward the chest.

#### THE HYPO-GLOSSAL, OR TWELFTH CRANIAL NERVE.

This nerve is sometimes called the *sublingual nerve*, thus using a Latin rather than Greek term to express the same idea, viz., that the nerve passes underneath the tongue. It is the last of the cranial nerves, and is intimately associated with all those movements in which the tongue takes an important part, such as the acts of talking, singing, mastication, and deglutition. The point of external origin of this nerve is a

groove between the *olivary body* of the medulla oblongata and the *anterior pyramid*, below the point of escape of the ninth, tenth, and eleventh nerves. Its deep fibers can be traced to a nucleus in the floor of the fourth ventricle, and it is probable that some of them decussate in the median line of the floor of that cavity, thus passing to the opposite side of the medulla. The nerve escapes from the cavity of the cranium by the *anterior condyloid foramen*.

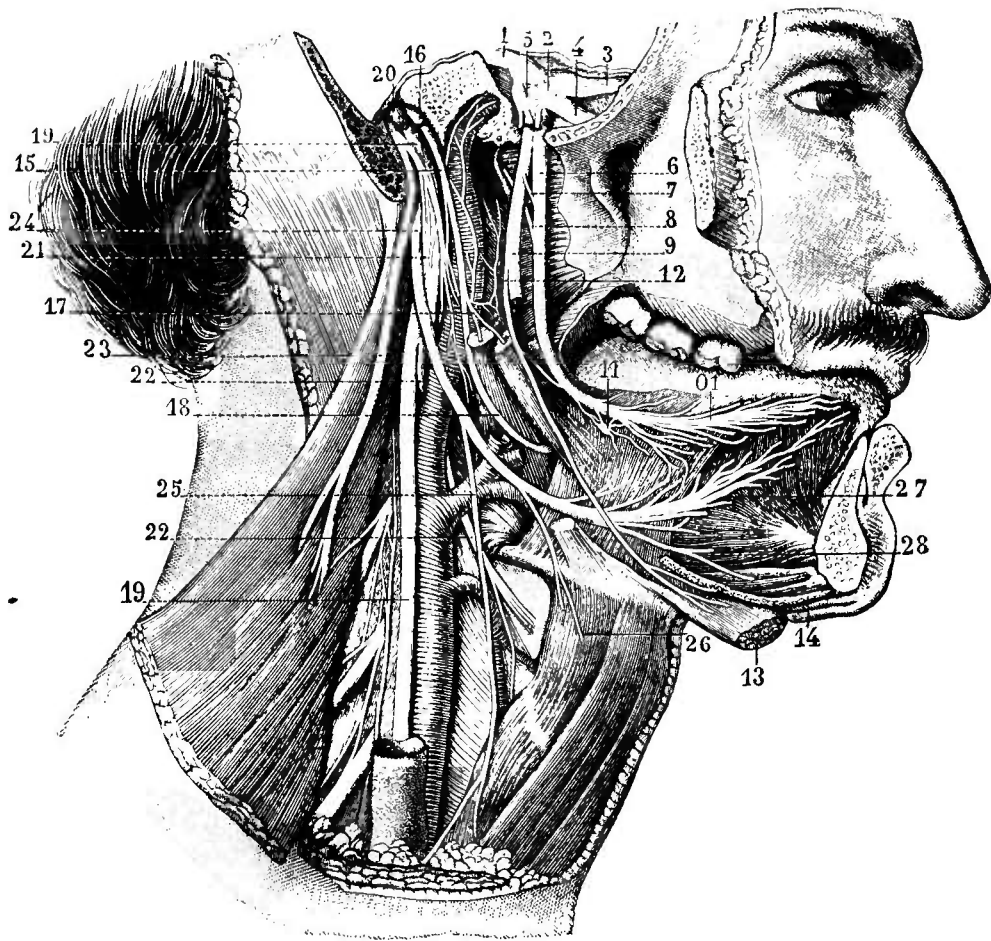

FIG. 100.—Distribution of the hypoglossal nerve. (Sappey.)

1, root of the fifth nerve; 2, ganglion of Gasser; 3, 4, 5, 6, 7, 9, 10, 12, branches and anastomoses of the fifth nerve; 11, submaxillary ganglion; 13, anterior belly of the digastric muscle; 14, section of the mylo-hyoid muscle; 15, glosso-pharyngeal nerve; 16, ganglion of Andersch; 17, 18, branches of the glosso-pharyngeal nerve; 19, 19, pneumogastric; 20, 21, ganglia of the pneumogastric; 22, 22, superior laryngeal branch of the pneumogastric; 23, spinal accessory nerve; 24, *hypoglossal nerve*, 25, *descendens noni*; 26, *thyro-hyoid branch*; 27, *terminal branches*; 28, *two branches, one to the genio-hyo-glossus and the other to the genio-hyoid muscle*.

After the nerve escapes from the cranium, it gives a filament of communication to the *sympathetic nerve*, which joins

the superior cervical ganglion ; another to the *pneumogastric nerve* ; two or three branches to the *upper cervical nerves* ;

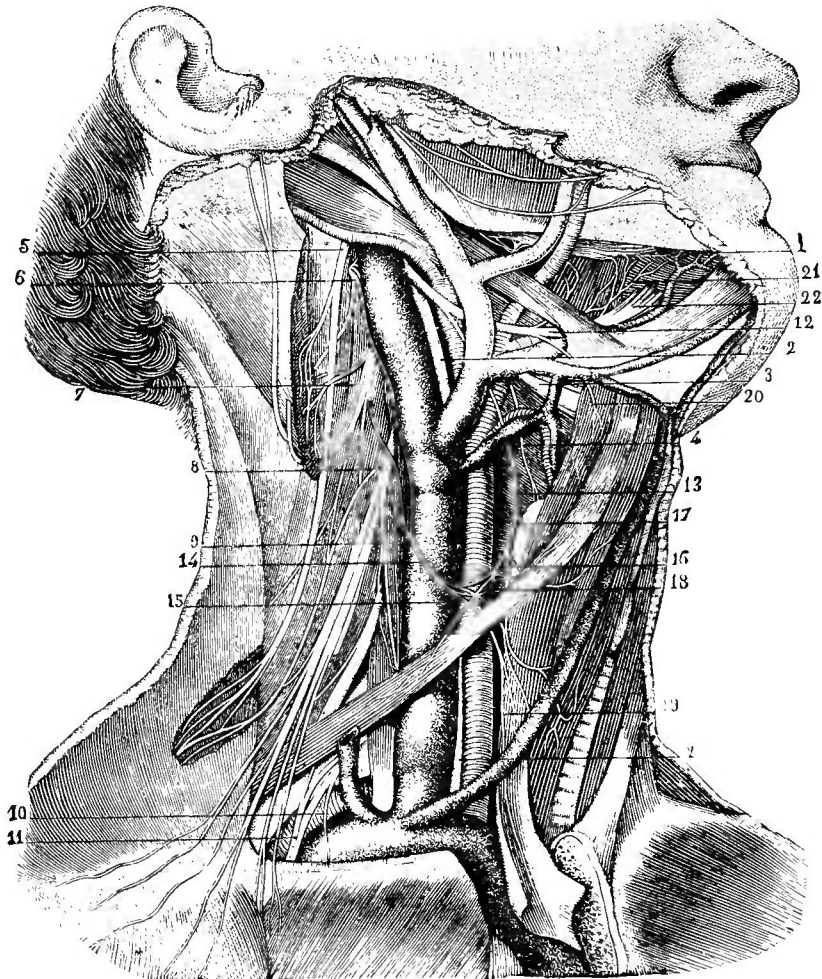

FIG. 101.—Anastomotic loop formed by the descending branch of the hypo-glossal and the internal descending branch of the cervical plexus. (After Hirschfeld.)

1, lingual nerve passing transversely upon the hyo-glossus muscle ; 2, 2, trunk of the pneumogastric ; 3, superior laryngeal nerve ; 4, external laryngeal nerve ; 5, external branch of the spinal accessory supplying the sterno-mastoid and trapezius ; 6, anterior branch of the second pair of cervical nerves ; 7, anterior branch of the third pair ; 8, anterior branch of the fourth pair ; 9, origin of the phrenic ; 10, origin of the subclavian nerve ; 11, origin of the anterior thoracic nerves of the brachial plexus ; 12, middle portion of the trunk of the hypo-glossal ; 13, descendens noni ; 14, internal descending branch of the cervical plexus, forming, with the preceding, a loop with its convexity directed downward ; 15, inferior branch from this loop, supplying the sterno-thyroid muscle ; 16, superior branch distributed to the sterno-hyoid muscle ; 17, another branch still higher up, and distributed to the same muscle ; 18, middle branches from the loop ; 19, filament extending as far as the lower extremity of the sterno-thyroid ; 20, branch given off by the hypo-glossal to the thyro-hyoid ; 21, branches of anastomosis between the hypo-glossal and lingual ; 22, terminal portion of the trunk of the hypo-glossal.

and, finally, a communicating branch to the *gustatory branch* of the *fifth nerve*.

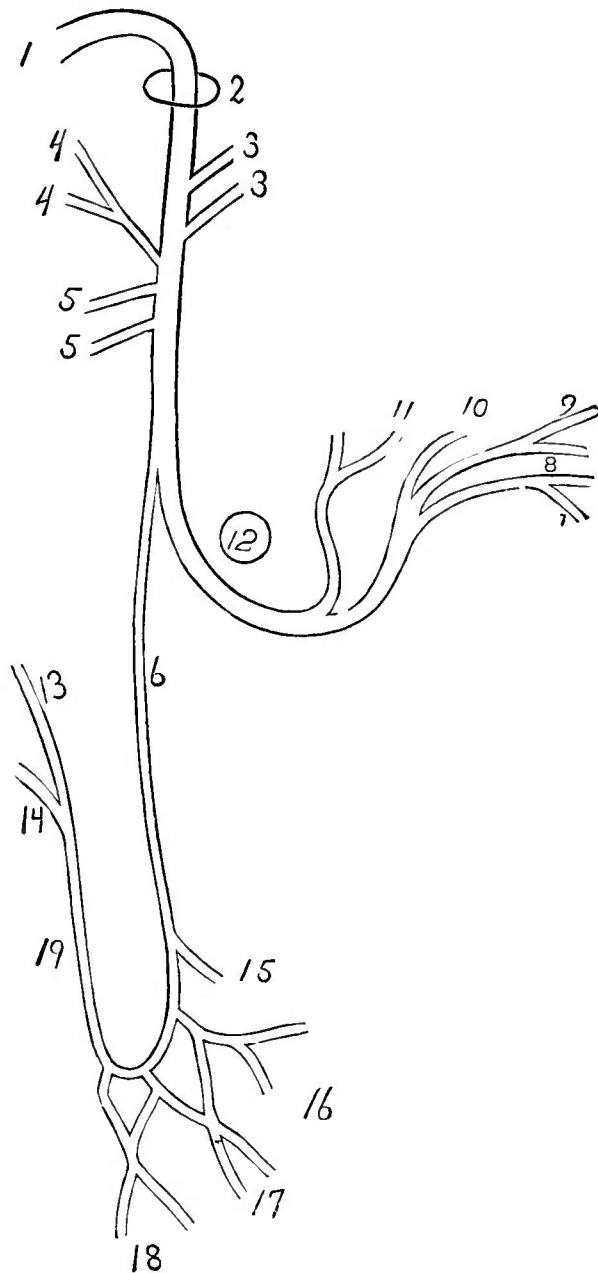

FIG. 102.—A diagram of the hypo-glossal and its branches.

- 1, trunk of *hypo-glossal nerve*, escaping from the medulla oblongata; 2, *anterior condyloid foramen*; 3, filaments of communication to the *pneumogastric nerve*; 4, filaments of communication to the *superior cervical ganglion* of the sympathetic system; 5, filaments of communication to the first and second spinal nerves of the cervical region; 6, the *descendens noni* nerve, forming a loop with the *communicans noni* nerve (19) and giving off muscular branches from the loop; 7, muscular filaments to the *thyro-hyoid* muscle; 8, muscular filament to the *genio-hyoid* muscle; 9, muscular filament to the *genio-hyo-glossus* muscle; 10, muscular filament to the *hyo-glossus* muscle; 11, muscular filament to the *stylo-glossus* muscle; 12, the *occipital artery*, around which the hypo-glossal nerve winds, before reaching the tongue; 13, a branch of the *communicans noni* nerve, derived from the second cervical nerve; 14, a branch of the *communicans noni* nerve, derived from the third cervical nerve; 15, a muscular branch to the *omo-hyoid* muscle (anterior belly); 16, a muscular branch to the *sterno-hyoid* muscle; 17, a muscular branch to the *sterno-thyroid* muscle; 18, a muscular branch to the *omo-hyoid* (posterior belly); 19, the *communicans noni* nerve, joining the *descendens noni* nerve to form a loop.

Its first branch of distribution is named the *descendens noni* (the descending of the ninth nerve), so called since this nerve was classed by Willis as the ninth. This branch passes down the neck to supply the sterno-hyoid, sterno-thyroid, and omo-hyoid muscles, and then joins the *communicans noni nerve* (a branch of the cervical plexus), to form a loop, from which terminal filaments are given off. The other branches of the nerve are distributed to the thyro-hyoid muscle (which usually has a separate filament of its own), the stylo-glossus, the hyo-glossus, genio-hyoid, genio-hyo-glossus, and the intrinsic muscles of the tongue. It will thus be seen that the hypo-glossal nerve is the motor nerve of all the muscles which tend to *depress the larynx and the hyoid bone*, after they have been raised during the second stage of the act of deglutition (the muscles of the infra-hyoid region), also to one of the supra-hyoid region, the genio-hyoid, and to most of the muscles which act upon the tongue.

In the preceding diagrammatic figure, the branches of the hypo-glossal nerve are shown, and the general course of the nerve is made more clear than can be done by a verbal description.

TABLE OF THE BRANCHES OF THE HYPO-GLOSSAL NERVE.<sup>1</sup>

THE HYPO-GLOSSAL, OR TWELFTH CRA- NIAL NERVE.	{	<i>Branches of communication.</i>	{	To the <i>ganglion of the trunk</i> of the pneu- mogastric nerve, To the <i>superior cervical ganglion</i> of the sympathetic, To the <i>loop</i> between the first and second cervical nerves, To the <i>gustatory nerve</i> .
		<i>Branches of distribution.</i>	{	<i>Descendens noni</i> nerve, To thyro-hyoid nerve, To genio-hyoid muscle, To stylo-glossus muscle, To hyo-glossus muscle, To genio-hyo-glossus muscle, To the intrinsic muscles of the tongue.

#### FUNCTIONS OF THE HYPO-GLOSSAL NERVE.

The fact that the hypo-glossal nerve arises from the motor portion of the spinal cord (when taken in connection with the

<sup>1</sup> Copied from the "Essentials of Anatomy" (Darling and Ranney). Putnam's Sons, New York, 1880.



absence of any ganglionic enlargement upon the trunk of the nerve) would seem to indicate that the function of the hypoglossal is essentially motor; and such a conclusion is sustained by the experiments of Longet, who found the nerve incapable of transmitting any sensory impressions when the roots were subjected to irritation.

Mayo and Magendie, however, first proved that the nerve possessed sensory filaments, after it had escaped from the cavity of the cranium, which results have since been confirmed by most of the later physiologists. We can easily explain this acquired power of sensibility which the nerve exhibits, by the *branches of communication* which it receives from the pneumogastric, the cervical nerves, and the gustatory branch of the fifth nerve; so that there is little, if any, reason to doubt that the original fibers of the nerve itself are purely motor in function.

In connection with the glosso-pharyngeal nerve, I entered into a somewhat extended discussion of the mechanism of the act of deglutition;<sup>1</sup> and the same subject might, with equal propriety, be again repeated in connection with the hypoglossal nerve, since both are intimately associated with those complex movements. It will suffice, however, to again call attention to the fact, that *movements of the tongue* were of the greatest importance in swallowing, since that organ not only conveyed the bolus to the back portion of the mouth, and, when liquids were to be swallowed, helped to form a tube through which a suction force could be exerted, but also assisted in the prevention of food from entering the cavity of the larynx.

#### CLINICAL POINTS PERTAINING TO THE HYPO-GLOSSAL NERVE.

When this nerve is divided in animals, the sense of taste remains and the tongue retains its normal sensitiveness; but the power of movement is utterly destroyed if the nerves of both sides are simultaneously cut. As a natural consequence, the first stage of the act of deglutition is materially embar-

rassed, and the second stage is liable to be associated with the entrance of fluid, if swallowed, into the cavity of the larynx.

When, in the human subject, this nerve is impaired, either as a special type of paralysis or during an attack of hemiplegia, the power of protrusion of the tongue from the mouth in a *straight line* is lost, and that member becomes deflected toward the side which is paralyzed, since the genio-hyo-glossus muscle is unopposed. A disease of rather rare occurrence, in which the hypo-glossal nerves of both sides are paralyzed, and, in addition, the orbicular muscle of the mouth, and, not infrequently, the intrinsic muscles of the larynx, is described by Duchenne;<sup>1</sup> and, since his article, it has been



FIG. 103.—*Glosso-labio-laryngeal paralysis.* (After Hammond.)

written upon by most of the later authors under the names of glosso-labio-laryngeal paralysis, glossoplegia, etc. In this type of disease the tongue lies motionless and trembling in the

<sup>1</sup> "De l'électrisation localisée," Paris, 1861.

floor of the mouth, if all power of motion be paralyzed; but, if paresis only exist, it can be imperfectly protruded with difficulty, and is tremblingly and slowly retracted. If one side be affected, the sound side becomes full and prominent, in comparison with the affected side, when called into action. The peculiar trembling character of the movement of the tongue in bilateral paresis is observed in every motion which the patient attempts to perform with that organ, and all the motions are slowly and imperfectly accomplished.

The most important effects of the paralytic state of the muscles are shown in attempts at *mastication* and *speech*. The food is no longer properly placed between the teeth; is with great difficulty carried to the back part of the mouth; and frequently regurgitates into the mouth, when attempts are made to swallow. The saliva is secreted in large quantities, and is swallowed with extreme difficulty, so that the patient is constantly obliged to expectorate.



FIG. 104.—*Glosso-labio-laryngeal paralysis.* (After Hammond.)

The *disturbances of speech* may present themselves with varying degrees of intensity. In those cases where the tongue is affected upon one side only (and a state of paresis exists, rather than that of complete paralysis of motion), only those sounds which require the aid of the tongue to be pronounced

are indistinctly and incompletely articulated. These letters are *s*, *sch*, *l*, *e*, *i*, and, at a later period, *k*, *g*, *r*, etc.

When the paralysis is bilateral, and the tongue has undergone atrophy, the speech becomes exceedingly indistinct, muttering and inarticulate, so that the patient can hardly express himself in sounds that can be understood by those in constant communication with him. The *act of singing* is always affected in even the mild forms of lingual paralysis; and the *false notes* are particularly affected, since the tongue plays an important part in so directing the sound as to give it its proper *timbre*.

The effects of lingual paralysis must not be confounded with spasm of the lingual muscles (the act of stuttering), or, on the other hand, with dumbness and aphonia.

In some cases of Duchenne's disease, the lips are not affected; while, in others, the laryngeal and pharyngeal muscles are not impaired to a sufficient degree to cause any serious impediment to their normal functions. We can the better understand why all possible varieties and degrees of paralysis may exist in this disease when we consider that, in order to account for all the symptoms present in a fully developed case, the *facial*, *spinal accessory*, *pneumogastric*, and *hypo-glossal* nerves must be simultaneously diseased, or subjected to extreme pressure. Should the facial nerve escape, the lips and face will preserve their normal power; if the spinal accessory nerve be unimpaired, the larynx may escape, provided that the pneumogastric nerve remain intact below the point of communication between these two nerves; if the hypo-glossal nerve be normal, the symptoms referable to the tongue would not be detected. The essential lesion of this disease seems to consist of a degeneration of the medulla oblongata and the upper portion of the spinal cord; hence the nuclei of origin of the facial, spinal accessory, pneumogastric, and hypo-glossal nerves are liable to be involved to a greater or less extent simultaneously. Whether the view of Leyden, that the condition is one of myelitis, will be sustained, is still uncertain, but that the condition closely re-

sembles that which creates the spinal paralysis of the infant and adult seems positive.

The previous existence of the early manifestations of syphilis and the probable activity of the disease in the system may account for the lesion in some cases, while in others the rheumatic diathesis, mental anxiety, and excessive mental application,<sup>1</sup> seem to have acted as exciting causes.

The general paralysis of the insane often first manifests itself in a peculiar weakness of the tongue and lips.

The tremor of *paralytic dementia* probably first makes its appearance in the facial and lingual muscles. It consists in non-rhythmical contractions of small muscles or of fasciculi of muscles, which are either present in the quiescent state of the features, or are excited by emotion or by the performance of a voluntary movement, as showing the tongue or teeth. Sometimes innumerable fine, fibrillary tremors cover the face, while, in some cases, the movements are coarser, and irregular enough to merit the term choreic. The tongue exhibits both sets of tremors—the very fine fibrillary ones and the large choreic oscillations. There is, also, though usually at a later stage, some shriveling or atrophy of the tongue. I quote from a late article of Professor E. C. Seguin,<sup>2</sup> as follows:

“The hands are tremulous, usually in a fine, semi-rhythmical way. This trembling is sometimes scarcely visible, but is perceptible as a delicate parchment-like fremitus on holding up the patient’s extended fingers between ours. In the lower extremities the tremulousness is not apparent.

“The speech is affected as a result of this tremor, and as the result of a certain want of coördination in the muscles of articulation. Words are quickly spoken, with some syllables omitted or blurred, or with a terminal syllable left off. The articulate sounds which are produced are heard as vibratory or tremulous, and the speech seems thick. Patients semi-unconsciously avoid long or difficult words in conversation, and

<sup>1</sup> Such cases as these are reported in the admirable description of this complicated affection by my colleague and friend Professor W. A. Hammond: “Treatise on the Diseases of the Nervous System.” New York: D. Appleton & Co., 1876.

<sup>2</sup> “Med. Record,” 1881.

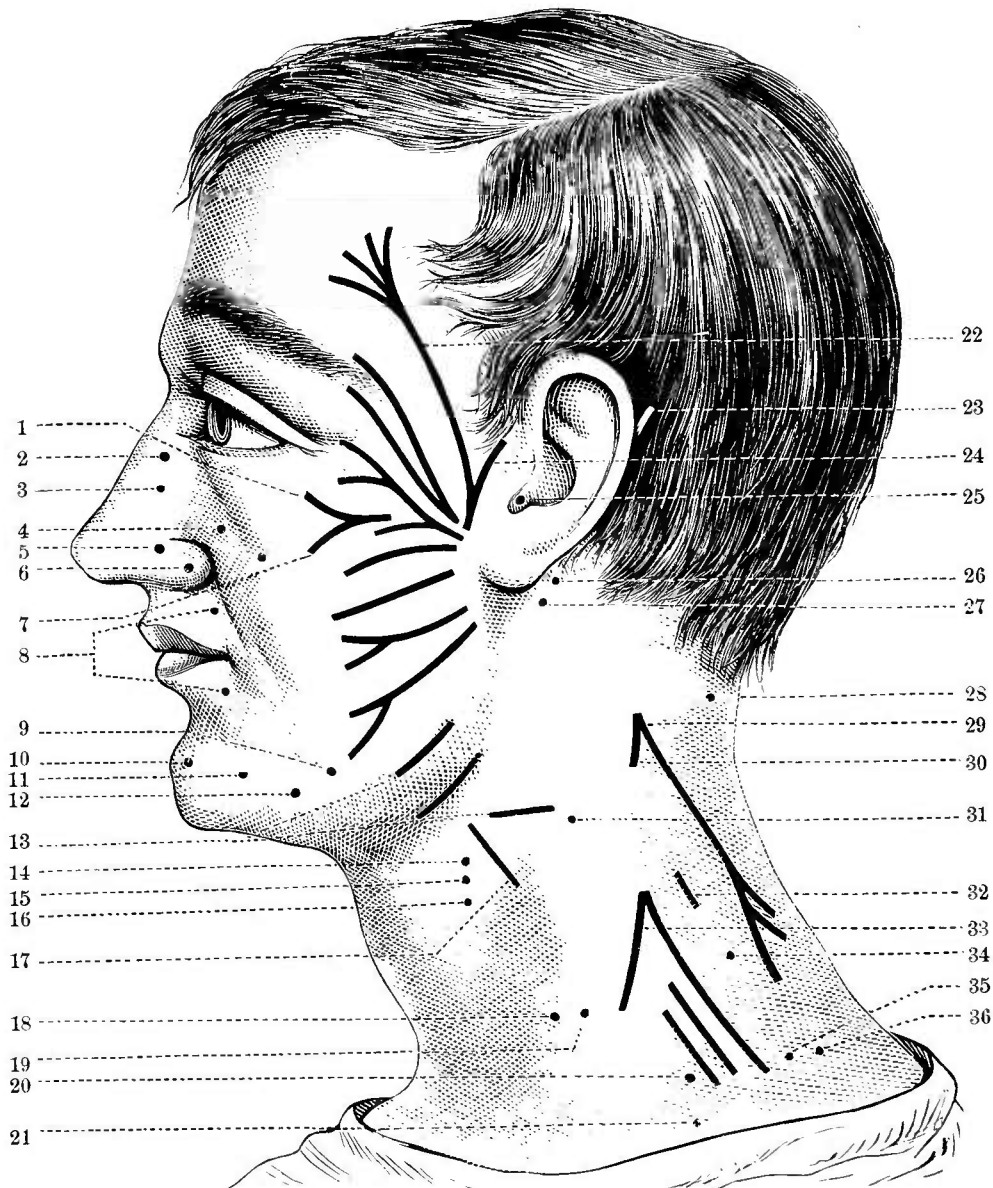

FIG. 105.—A diagram of the motor points of the face, showing the position of the electrodes during electrization of special muscles and nerves. The anode is supposed to be placed in the mastoid fossa, and the cathode upon the part indicated in the diagram.

- 1, m. orbicularis palpebrarum; 2, m. pyramidalis nasi; 3, m. lev. lab. sup. et nasi; 4, m. lev. lab. sup. propr.; 5, 6, m. dilator naris; 7, m. zygomatic major; 8, m. orbicularis oris; 9, n. branch for levator menti; 10, m. levator menti; 11, m. quadratus menti; 12, m. triangularis menti; 13, nerves—subcutaneous of neck; 14, m. sterno-hyoid; 15, m. omo-hyoid; 16, m. sterno-thyroid; 17, n. branch for platysma; 18, m. sterno-hyoid; 19, m. omo-hyoid; 20, 21, nerves to pectoral muscles; 22, m. occipito-frontalis (ant. belly); 23, m. occipito-frontalis (post. belly); 24, m. retrahens and attollens aurcm; 25, nerve—facial; 26, m. stylo-hyoid; 27, m. digastric; 28, m. splenius capitis; 29, nerve—external branch of spinal accessory; 30, m. sterno-mastoid; 31, m. sterno-mastoid; 32, m. levator anguli seapulæ; 33, nerve—phrenic; 34, nerve—posterior thoracic; 35, m. serratus magnus; 36, nerves of the axillary space.

even seek roundabout ways of expressing their meaning by shorter words. Besides this vibratory tremulousness in

articulation, there is an imperfection in the pronunciation of words—long words especially. Remedy is pronounced ‘remdy’; constitution, ‘constution’; infallibility, ‘infallaby’ The last syllable may be badly sounded, or even omitted. I have known this characteristic speech to be the only well-marked symptom, and to be followed by dementia, exaltation, etc. Occasionally, a patient comes to us complaining of this defective articulation.”

Interference with the free action of the hypo-glossal nerve, when not associated with a simultaneous affection of other nerves, may result in the production of spasm or paralysis.

*Spasm of the tongue* may be perceived in connection with the spasmodic diseases, such as chorea, epilepsy, and hysteria; also, as a result of slight compression or irritation of the hypoglossal nerve from meningeal exudation; while a *fibrillary tremor* of the tongue is observed in progressive muscular atrophy. In severe types of facial spasm, and in those forms of disease where the lingual nerve is the seat of a neuralgic affection, the hypo-glossal nerve may create a type of clonic spasm.

*Paralysis of the tongue* is usually unilateral, and may be the result of cerebral hæmorrhage, softening, embolism, tumors, or the progressive paralysis of the insane. In rare cases, this condition has occurred from injury done to the nerve from the removal of a tumor of the tongue itself; while instances have been reported where the nerve was impaired by pressure upon its trunk, either at the base of the brain, or at its point of escape from the anterior condyloid foramen.





# THE SPINAL CORD.

*ITS ANATOMICAL CONSTRUCTION, FUNCTIONS, AND  
CLINICAL BEARINGS.*



## THE SPINAL CORD.

IN the previous lectures of this winter's course, we have considered the anatomy of the brain, and the nerves which arise from it. We have noted the general points in the construction of each, and discussed the clinical bearings of the individual parts which have successively demanded our attention. It now remains for us to begin the study of the other great half of our nervous organism, viz., the spinal cord, and the nerves which are connected with it. I shall follow the same general plan, in treating of the spinal cord and its nerves, as I have pursued in the early part of the course, viz., to give such points only in the descriptive portion as shall conduce to a full comprehension of the clinical bearings of the regions under discussion, and to impress upon you constantly such suggestions of practical value as the theme recalls to my mind. Should the anatomical description of the separate parts seem, at any time, incomplete, I trust to omit nothing that can not be easily supplied from the best text-books upon anatomy; but I shall fall short of my proposed task if I fail to incorporate such points as shall assist you in comprehending many of the new terms found scattered throughout the more advanced treatises upon the anatomy and diseases of the nervous system.

The spinal cord comprises that part of our central nervous system which is contained within the canal of the vertebral column. It may be said to begin at the point where the

fibers of the anterior pyramids of the medulla oblongata begin to decussate (which point corresponds to the upper border of the atlas), and it terminates at the lower border of the first lumbar vertebra. It may then be stated that the entire length of the spinal cord varies from fifteen to eighteen inches (since it depends somewhat upon the height of the in-

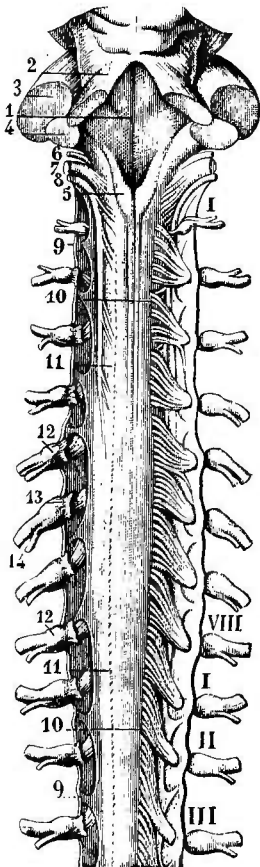

FIG. 106.—*Cervical portion of the spinal cord.* (Hirschfeld.)

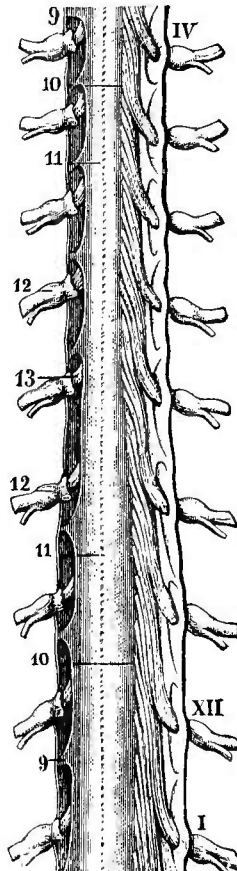

FIG. 107.—*Dorsal portion of the spinal cord.* (Hirschfeld.)

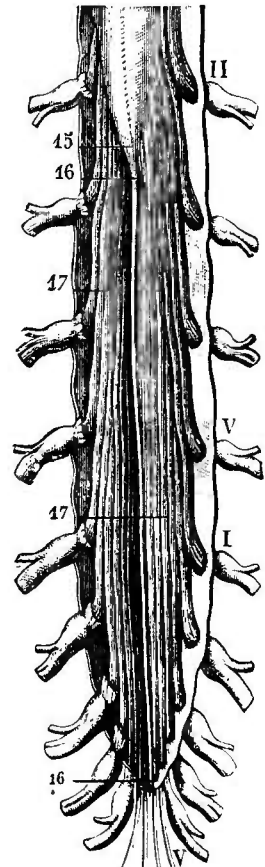

FIG. 108.—*Inferior portion of the spinal cord, and cauda equina.* (Hirschfeld.)

1, antero-inferior wall of the fourth ventricle ; 2, superior peduncle of the cerebellum ; 3, middle peduncle of the cerebellum ; 4, inferior peduncle of the cerebellum ; 5, inferior portion of the posterior median columns of the cord ; 6, glosso-pharyngeal nerve ; 7, pneumogastric ; 8, spinal accessory nerve ; 9, 9, 9, 9, dentated ligament ; 10, 10, 10, 10, posterior roots of the spinal nerves ; 11, 11, 11, 11, posterior lateral groove ; 12, 12, 12, 12, ganglia of the posterior roots of the nerves ; 13, 13, anterior roots of the nerves ; 14, division of the nerves into two branches ; 15, lower extremity of the cord ; 16, 16, coccygeal ligament ; 17, 17, cauda equina ; I—VIII, cervical nerves ; I, II, III, IV—XII, dorsal nerves ; I, II—V, lumbar nerves ; I—V, sacral nerves.

dividual), and that it does not extend throughout the entire length of the spinal canal. Its upper end is continuous with

the lower part of the medulla oblongata (which, in my opinion, seems more properly a part of the cord than of the brain), while its lower end terminates in a slender filament, called the "filum terminale," which descends for a short distance into the central ligament.

#### THE GENERAL CONSTRUCTION OF THE CORD.

The spinal cord is not of the same size or general shape in all portions of its length, since it tapers gradually toward its lower extremity, with the exception of presenting two local enlargements, called the "*cervical*" and "*lumbar*" enlargements.<sup>1</sup> The former of these extends from the third cervical to the first dorsal vertebra, and is widest from side to side ;

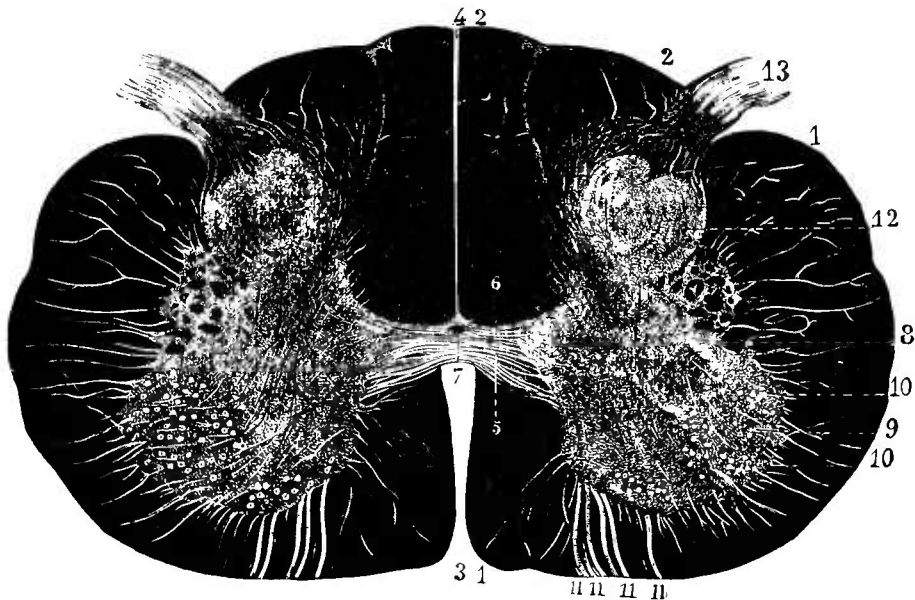

FIG. 109.—*Transverse section of the spinal cord at the origin of the fifth pair<sup>2</sup> of cervical nerves.* (Stilling.)

In this figure, the white substance of the cord is represented in black, to show more clearly the limits of the gray matter: 1, 1, antero-lateral columns; 2, 2, posterior white columns; 3, anterior median fissure; 4, posterior median fissure; 5, white commissure; 6, gray commissure; 7, central canal; 8, 9, anterior cornua of gray matter; 10, 10, group of large multipolar cells; 11, 11, 11, anterior roots of the spinal nerves; 12, posterior cornua of gray matter; 13, posterior roots of the spinal nerves.

while the latter extends from the lower part of the eleventh dorsal to the lower border of the twelfth dorsal vertebra, and

<sup>1</sup> These enlargements correspond to the points of origin of the main nerves of the upper and lower extremities.

<sup>2</sup> The line designated by Gubler. See page 183.

is widest from before backward. When viewed exteriorly, the cord presents *five fissures* and *four columns*, which are less distinct than the convolutions of the cerebrum ; and, on section made transversely across its substance, two general subdivisions can be made out by the naked eye, the *white* and the *gray portions*. When we come to discuss the clinical points pertaining to spinal localization, in case of disease, you will then realize that the further subdivisions of the spinal cord, which I shall impress upon your memories, are not based alone upon the results of enthusiastic microscopy, but are the grand evidences of a progress in this direction which the earlier anatomists had not dreamed of, and which are the foundation, I sincerely believe, of accurate and positive diagnosis of spinal lesions at no distant date.

The general exterior of the spinal cord is incompletely divided into two *symmetrical lateral halves*, by the so-called "antero-median fissure" and the "postero-median fissure," which do not cut the cord entirely in half, since a transverse commissure exists, called the "*commissure of the spinal cord*." Now, this point is worthy of your careful attention, since it indicates a clinical fact, viz., that lesions of one lateral half of the cord produce symptoms in a lateral half of the body.

*Each lateral half* of the cord has *three fissures* of its own : the "antero-lateral fissure," which corresponds to the points of escape of the anterior roots of the spinal nerves ; the "postero-lateral fissure," which corresponds to the points of attachment of the posterior roots of the spinal nerves ; and the "postero-intermediary fissure,"<sup>1</sup> which is situated on the outer side of the postero-median fissure, which helps to divide the cord into its two lateral halves. The first two of these are mere traces upon the surface of the cord, while the last is most apparent in the cervical region.

As demarcated by the fissures named above, the spinal cord presents four subdivisions of its exterior surface, called respectively the "anterior," "lateral," "posterior," and

<sup>1</sup> Described by Sappey, Hirschfeld, and others.

“postero-median” columns.’ These are, however, of less importance, from a clinical standpoint, than the columns named after certain special investigators in this line of science;

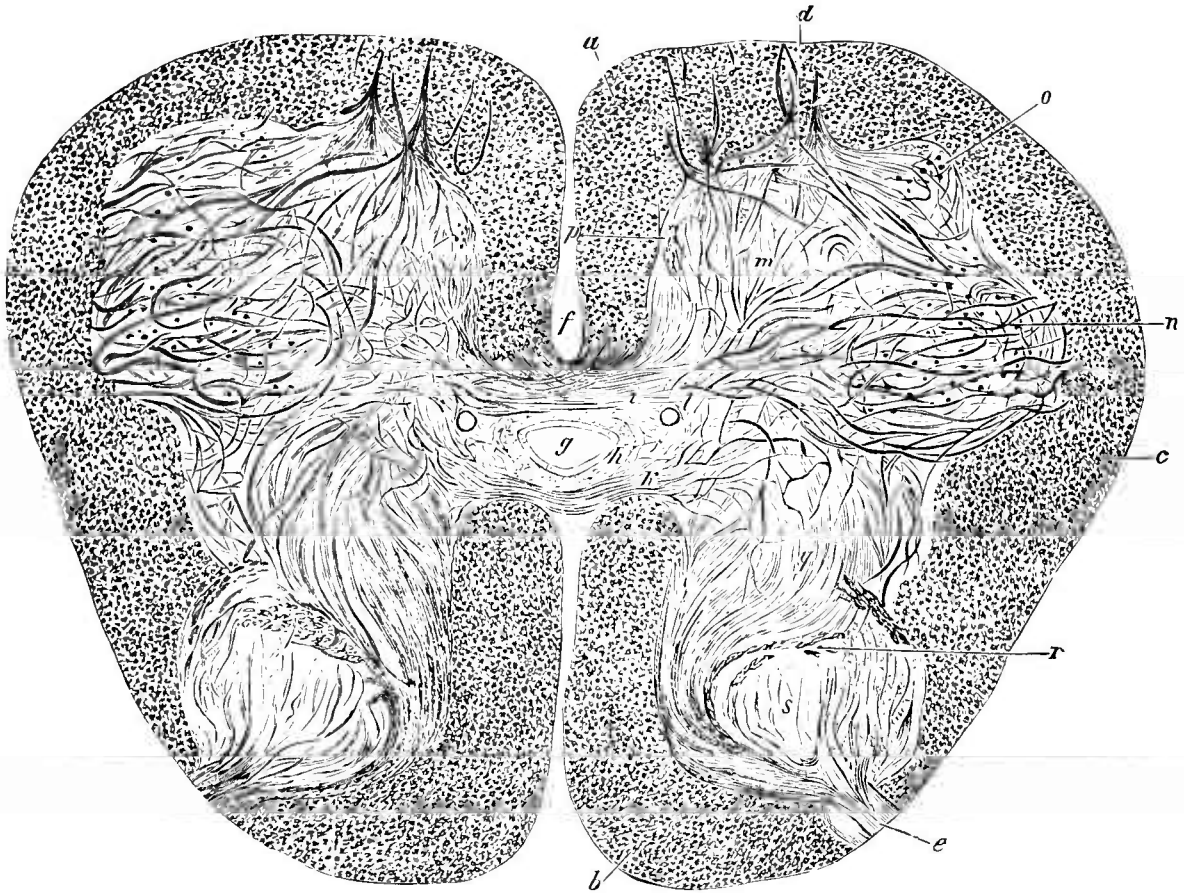

FIG. 110.—*Transverse section of the spinal cord of a child six months old, at the middle of the lumbar enlargement, treated with potassio-chloride of gold and nitrate of uranium; magnified 20 diameters. By means of these reagents, the direction of the fibers in the gray substance is rendered unusually distinct. (Gerlach.)*

*a*, anterior columns; *b*, posterior columns; *c*, lateral columns; *d*, anterior roots; *e*, posterior roots; *f*, anterior white commissure, in communication with the fasciculi of the anterior cornua and the anterior columns; *g*, central canal with its epithelium; *h*, surrounding connective substance of the central canal; *i*, transverse fasciculi of the gray commissure in front of the central canal; *k*, transverse fasciculi of the gray commissure behind the central canal; *l*, transverse section of the two central veins; *m*, anterior cornua; *n*, great lateral cellular layer of the anterior cornua; *o*, lesser anterior cellular layer; *p*, smallest median cellular layer; *q*, posterior cornua; *r*, ascending fasciculi in the posterior cornua; *s*, substantia gelatinosa.

which can better be demonstrated by a reference to the cuts showing the transverse section of the spinal cord.<sup>2</sup>

The spinal cord gives off *thirty-one pairs of nerves*, called

<sup>1</sup> Some anatomists include the lateral with the anterior column, under the name of the “antero-lateral column,” thus taking in about two thirds of the entire lateral half of the cord.

<sup>2</sup> See cut on page 298 of this volume, and colored plate (after Hammond).

“spinal nerves,” in contradistinction to those of cranial origin, which we have already considered. Each spinal nerve arises by two roots, which spring respectively from two of the fissures of the lateral halves of the cord, as has been mentioned; but these two roots soon join with each other to form the nerve, before it escapes from the spinal canal, to be distributed to the regions which it is destined to supply.

#### THE MEMBRANES OF THE SPINAL CORD.

As was the case with the encephalon, the spinal cord is invested from within outward by a *membrane of nutrition*, the pia mater; a *membrane of lubrication*, the arachnoid; and, finally, a *membrane of protection*, the dura mater. These three coverings differ in some respects from those covering the brain, but the differences have little if anything to do with the clinical aspects of the spinal cord, and they can be ascertained, if you desire to know them, by reference to any text-book on descriptive anatomy.

#### THE CEREBRO-SPINAL FLUID.

As mentioned in connection with the ventricular cavities of the brain, the spinal cord is immersed, as it were, in a fluid, the “*cerebro-spinal fluid*,” which has free entrance to and egress from the ventricles of the encephalon, since its function is to regulate and equalize the pressure<sup>1</sup> upon the nerve centers, when the blood supply suffers variations, as it does during respiration, in sleep, and in certain diseased conditions. This accounts for the fact that pressure made upon a “*spina bifida*”—a tumor containing this fluid protruding through an opening due to a congenital absence of the spinous processes of the vertebræ—often creates brain symptoms, if sufficient to create excessive intra-ventricular pressure.

The greater part of this fluid is contained in what is known

<sup>1</sup> Hilton considers this fluid as analogous, in respect to its function, to the elastic capsule of the various solid viscera. “*Rest and Pain*,” London, 1876.



as the *sub-arachnoidean space*, which is situated outside of the cavity of the arachnoid, between its inner layer and the pia mater of the cord. Its quantity was estimated by Magendie as about two fluidounces in the human subject; but a somewhat larger amount can be obtained by making an opening in the lumbar region and a counter-opening in the region of the head, so as to allow of the influence of atmospheric pressure in forcing its escape outward.<sup>1</sup>

This fluid may be drawn out of the spinal canal of a living animal, either by means of a simple trocar or a trocar attached to a suction tube. In the former method, no apparent influence of a detrimental character seems to follow a moderate escape; but, when a suction force is used to still further draw off the fluid, the animal becomes enfeebled and subsequently affected with symptoms of motor paralysis. The cerebro-spinal fluid is rapidly reproduced after its withdrawal, and is probably secreted by the pia mater. The fact that an increase of the intra-cerebral pressure will result in coma, if sufficiently intensified, is shown, in a clinical way, upon the human subject, by compression of a spina bifida; and the same result was proved by Magendie, who injected water into the sub-arachnoidean space of animals, and thus artificially induced a state of profound coma. The point of communication between the sub-arachnoidean space of the spinal canal and the ventricular cavities of the brain is situated in the *fourth ventricle*; hence, the fluid has to pass upward, through the aqueduct of Sylvius, to reach the third ventricle, and through the foramina of Monro, to enter the two lateral ventricles of the cerebrum. Hilton<sup>2</sup> claims that the basilar process of the occipital bone, which is the seat of some of the more important parts of the encephalon, is not in actual contact with the adjacent brain, but has a layer of the cerebro-spinal fluid interposed as a water-bed to protect the parts from injury from any form of concussion, and a similar condition probably exists in other parts.

<sup>1</sup> A. Flint, Jr., *op. cit.*

<sup>2</sup> *Op. cit.*

## APPEARANCE OF A TRANSVERSE SECTION OF THE SPINAL CORD.

The arrangement of the gray and white substance of the spinal cord is seen only on a transverse section. In order to properly appreciate the special points in the construction of these two portions, several transverse sections must be made at different heights in the cord, since the relative proportion of the gray and white substance differs in the cervical, dorsal, and lumbar regions. The regions usually selected for these transverse sections are the upper cervical portion, the center of the cervical enlargement, the center of the dorsal region, the lumbar enlargement, and the terminal portion of the cord. In the cervical region, the white substance is the most abundant; in the dorsal region, the gray matter is relatively smaller than at any other point; while, in the lumbar enlargement, the gray matter is the most extensively developed.

When we view the appearance of any portion of the spinal cord on transverse section, we will perceive that the gray matter is arranged in the same general way in all of its different regions. This has been compared to the capital letter "H," since its two lateral halves are connected together by a transverse band, "the transverse commissure of the gray substance." Each lateral half of the gray substance is *crescentic* in form, thus presenting an anterior and a posterior projection, termed the *anterior* and *posterior horns*,<sup>1</sup>

<sup>1</sup> The anterior horns, or cornua, are studded with large characteristic cells, which are unipolar or multipolar. Certain of these cells are possessed of a *peculiar process*, which differs from its companions in not branching, and in increasing in size as it passes away from the body of the cell. This is known as the "axis cylinder process," and it is claimed that it becomes clothed with myeline and is directly continuous with the axis cylinder of a motor nerve. We owe the discovery of this process in the human being to Deiters ("Untersuchungen über Gehirn u. Rückenmark," 1868), who asserted that it was also to be found appended to all central nerve cells; although, in 1874, R. Wagner ("Handwörterbuch") had observed a similar prolongation, sometimes two, in the central nervous organs of the torpedo, and Remak ("Deutsche Klinik," 1854, Nro. 27) had, in 1854, described the same peculiarity of structure in the anterior horn cells of the spinal cord in the ox. Deiters has been confirmed by a number of observers, among others by Max Schultze, Jolly, Gerlach, Arnold, Kölliker, Arndt, Kosehennikoff (see Henle, "Nervenlehre," 1879, § 29). These cells are distributed in groups, which are differently situated in different regions. (L. C. Gray, "Annals of Anat. and Surg. Soc.," Oct., 1880.)

the former of which is broad and blunted, and does not reach the surface of the cord, while the latter is thinner and more pointed, and approaches the exterior surface near the point of attachment of the posterior roots of the spinal nerves.

The white substance consists of the following component structures: 1, nerve fibers; 2, blood-vessels; and 3, connective-tissue elements. The gray matter, called also the "vesicular neurine," consists, 1, of nerve cells of variable shapes and sizes; 2, nerve fibers; 3, blood-vessels; and 4, connective-tissue elements. In the white substance, the nerve fibers are variable in point of size, and have a medullary sheath, but no investing membrane. In the gray matter the nerve fibers are small, and, in the posterior horns, form plexuses. The nerve cells are large and multipolar in the anterior horns, and smaller in the posterior horns.

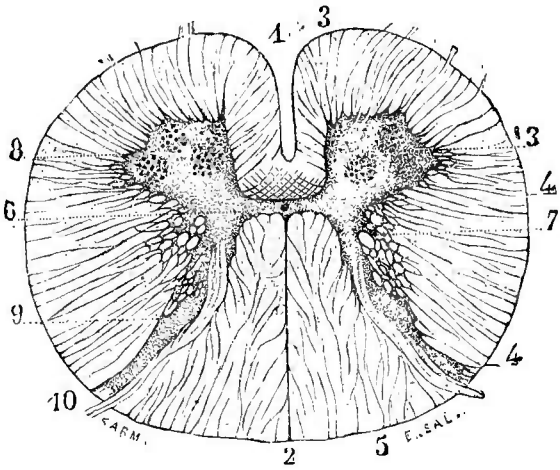
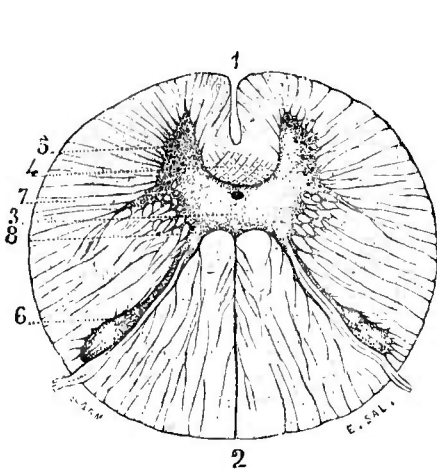

FIG. 111.—Section of the cord below the medulla oblongata. (Sappey.)

FIG. 112.—Section of the cervical enlargement of the cord. (Sappey.)

FIG. 111.—1, anterior median fissure; 2, posterior median fissure; 3, gray commissure, much thicker here than lower down; 4, white commissure formed by the decussation of the anterior columns; 5, anterior cornu; 6, posterior cornu; 7, lateral cornu.

FIG. 112.—1, anterior fissure; 2, posterior fissure; 3, 3, anterior columns of most authors; 4, 4, lateral columns (these columns in reality pass beyond the anterior cornua, and the anterior columns occupy less space than is here allowed them); 5, posterior columns; posterior commissure (here very narrow); 7, reticulated arrangement of the gray and white matter at the junction of the two cornua; 8, anterior cornu; 8, anterior cornu, in which the multipolar cells are distributed into three principal groups; 9, posterior cornu; 10, fifth pair of cervical nerves.

Passing through the center of the gray commissure, and extending for the greater portion of the length of the cord,

may be seen a small canal—the *central canal of the spinal cord.*<sup>1</sup> That portion of the gray commissure which lies in front of this canal may be called the “anterior gray commissure,” while the portion which lies behind it is called the

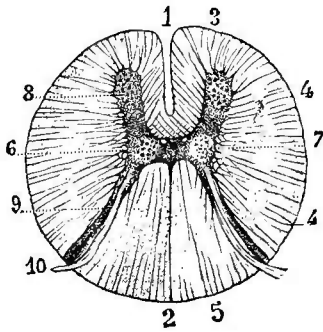

FIG. 113.—Section from the dorsal region of the cord. (Sappey.)

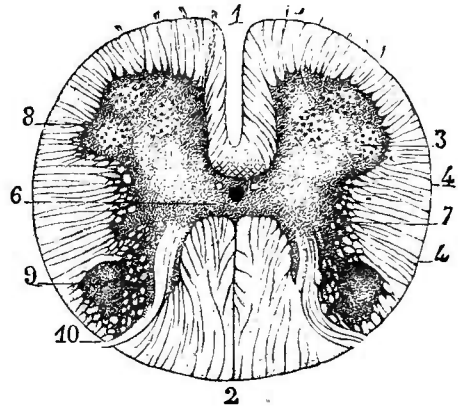

FIG. 114.—Section of the lumbar enlargement of the cord. (Sappey.)

FIG. 113.—1, anterior fissure; 2, posterior fissure; 3, anterior column situated within the corresponding cornu, and decussating in the median line with the column of the opposite side; 4, 4, lateral column reaching to the anterior column, but separated from it by no distinct line of demarkation; 5, posterior column; 6, 7, section of the columns of Clarke, situated at the two extremities of the gray commissure, at the junction of the anterior and posterior cornua, and containing large multipolar cells; 8, anterior cornu; 9, posterior cornu; 10, posterior root of dorsal nerves.

FIG. 114.—1, anterior fissure; 2, posterior fissure; 3, 3, anterior columns of most authors; 4, 4, lateral columns of most authors; 5, posterior column; 6, gray commissure and central canal, and, to the right and left of the latter, the orifices of two longitudinal veins; 7, reticulated arrangement of white and gray matter; 8, anterior cornu; 9, posterior cornu; 10, posterior root of the lumbar nerves.

“posterior gray commissure.” In front of the gray commissure a band of white nerve substance connects the two lateral halves of the cord, to which the term “anterior white commissure” is applied.

We can see, by such a transverse section, that the posterior horns divide the lateral half of the cord into two great subdivisions, the one lying anterior to it being called the *antero-lateral column*, and that posterior to it being known as the *posterior column*. In the colored plate, which is taken from the admirable work of my friend and colleague Profes-

<sup>1</sup> This canal is continuous, above, with the *fourth ventricle* of the brain; and the aqueduct of Sylvius is considered by some anatomists as a continuation of it above the fourth ventricle.

•

•

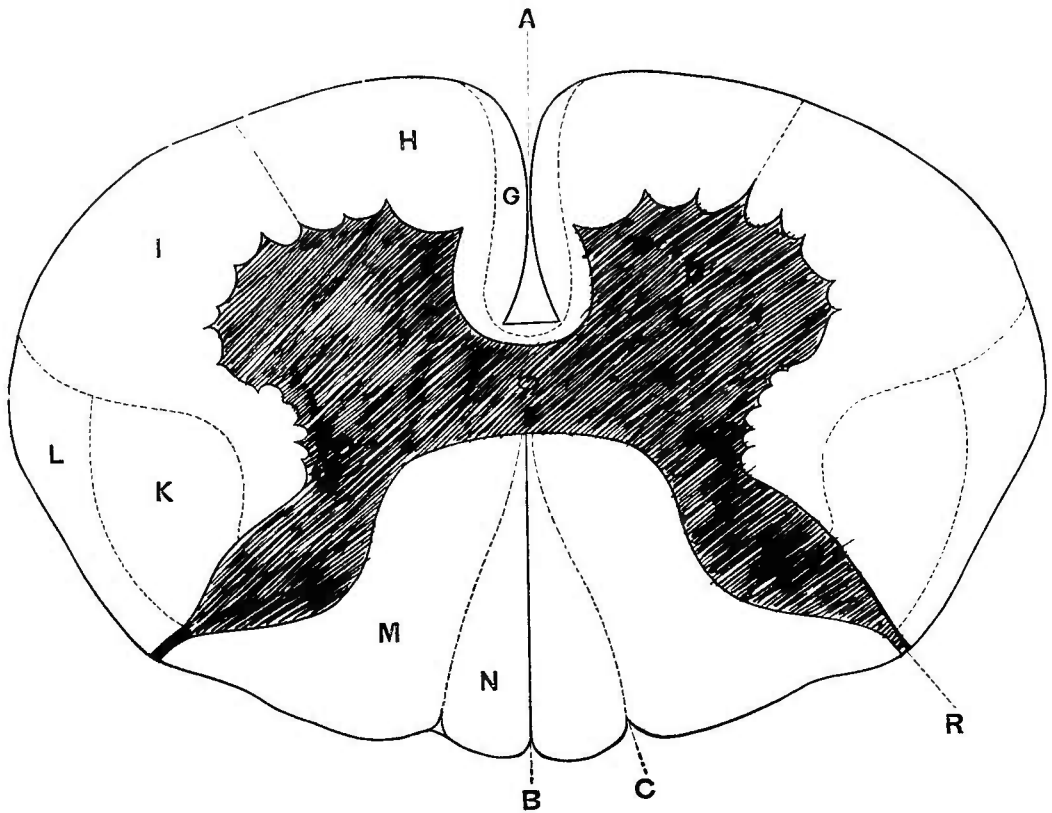

FIG. 115.—*Diagram illustrating the relations of the nerve-fiber tracts in the spinal cord.*  
The section is supposed to be taken transversely through the lower part of the cervical enlargement (slightly modified from Flechsig by Hammond):

- A. Anterior Median Fissure.
- B. Posterior Median Fissure.
- C. Intermediate Fissure.
- D. Anterior Gray Cornu.
- E. Posterior Gray Cornu.
- F. Gray Commissure, with Central Canal.
- G. Uncrossed Pyramidal Tract (Flechsig), or Column of Türk.
- H. Fundamental Part of the Anterior Column (Anterior Root-Zones of Chareot and his pupils).
- I. Anterior Part of Lateral Column.
- K. Crossed Pyramidal Tract of Lateral Column.
- L. Direct Tract from Lateral Column to Cerebellum.
- M. Column of Burdach, Posterior Root-Zones of Chareot and his pupils.
- N. Column of Goll.

The posterior columns of descriptive anatomy include the fields M and N extending on the surface from B to R. The antero-lateral columns extend on the surface from R to A. Their anterior division includes the fields G and H; their lateral division, the fields K, L, and I.

sor Hammond, it will be, however, perceived that the simple anatomical divisions of the cord have been modified by pathological researches, so that certain special regions are now designated, and some are named after the investigator who first discovered their function. Thus, to-day, we more commonly read of the columns of Goll, of Türck, of Burdach, and of the "anterior root zone" and the "posterior root zone," than of the anatomical terms with which you are doubtless more familiar. This is not without benefit to those who expect to master the mechanism of the symptomatology of the more important types of spinal diseases, although it may for a while tend to confuse you; since the situation of lesions can be thus more simply expressed than in attempts to use terms which are inadequate to convey the idea. The anatomical subdivisions of the cord are fast becoming obsolete terms with the alienist, since they are based upon a purely structural foundation, irrespective of the physiological properties of the different parts.

A few words of explanation of this selected plate<sup>1</sup> will assist you, I trust, in mastering these new terms so readily that you will be able to follow my subsequent remarks with as much ease as if you had not been so long accustomed to the terms which will be, to a great extent, discarded. You will perceive that the gray matter is shown with its two anterior and two posterior horns (D and E); and also the antero-median and postero-median fissures, separating the cord into two lateral halves. In the anterior part, lying on each side of the antero-median fissure, are seen the "columns of Türck" (G), which are also called the "direct pyramidal columns," from the course of the nerve fibers which form them. On either side of these columns, extending backward toward the line of the transverse commissure of the cord, are the two regions (H) which, from their relation to the anterior roots, are called the "anterior root zones."<sup>2</sup> As we pass still farther backward, we next meet the two lateral columns (I), which, as you will see, are limited behind by the posterior horns of

<sup>1</sup> See Fig. 115.

<sup>2</sup> Called also the "*anterior fundamental column.*"

gray matter. Thus the antero-lateral column of the anatomist has already been split up into three distinct portions, each of which is specially named.<sup>1</sup>

This lateral column is sometimes further subdivided into the "direct cerebellar column" and the "crossed pyramidal column," as shown in the colored plate taken from Hammond, and also in an admirable schematic drawing which I have copied from Seguin.<sup>2</sup>

Behind, and adjoining the posterior horns of gray matter, you will see two greenish-colored portions (M), the posterior root zones, or the "columns of Burdach"; while upon either side of the postero-median fissure lie the "columns of Goll" (N), which are colored pink.

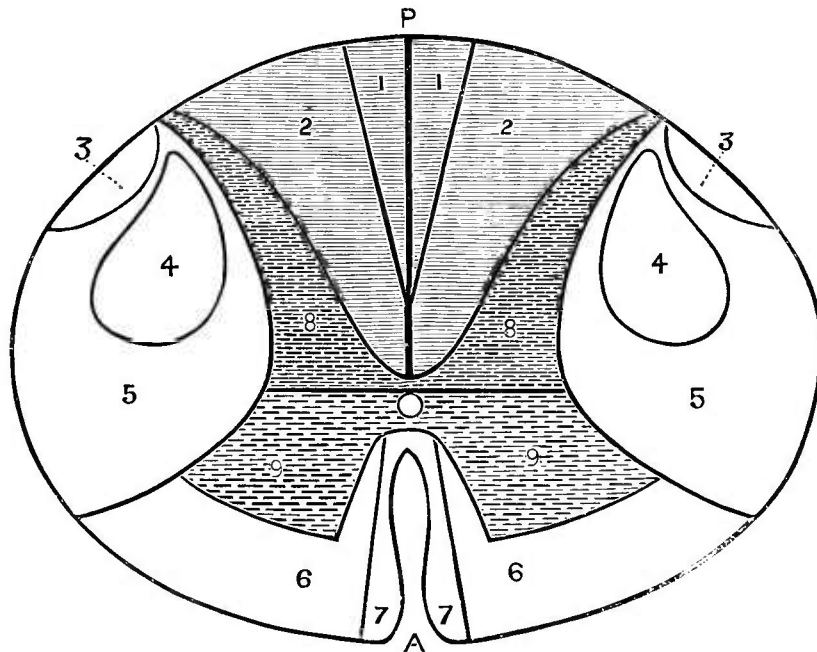

FIG. 116.—*Transverse section of the spinal cord and center.* (Seguin.)

A, anterior median fissure; P, posterior median septum: 1, columns of Goll; 2, columns of Burdach; 3, direct cerebellar column; 4, crossed pyramidal column; 5, lateral column; 6, anterior fundamental column; 7, direct pyramidal column (column of Türck); 8, posterior gray horns; 9, anterior gray horns. Stippled part—gray matter. Shaded part—æsthesodic system. Unshaded part—kinesodic system.

We can, again, thus perceive that the "posterior column" of the simpler classification, with which you are familiar, comprises the "columns of Goll and of Burdach."

<sup>1</sup> See researches of Flechsig, of Leipsic, regarding the course of fibers in the medulla oblongata and spinal cord.

<sup>2</sup> "Medical Record," 1878.



## FUNCTIONS OF THE SPINAL CORD.

Now, the questions may naturally arise to your minds: Why is such a digression from previously accepted terms so universally used, in preference to those more familiar and, possibly, simpler terms of nomenclature? Why should the columns of Türck, Goll, and Burdach be separated from each other when no anatomical line of division seems to have been created? Is the arrangement not a strained attempt to mystify and confuse the medical student, and does a sufficient ground exist for so great a departure from previous methods of description? In reply to such anticipated questions—and they have been asked of me many times—I would respectfully draw your attention to such points in the physiology and pathology of the spinal cord as will help to show you the necessity which existed for such modifications of previously familiar terms, as well as the advantages which are gained by those subdivisions of the cord which are now household words to the specialist on nervous diseases.

I would first call your attention to the fact that the spinal cord is an *organ of conduction*. The motor impulses, which affect the muscles of the different parts of the body, are unquestionably transmitted through it from the brain to the part destined to be acted upon; hence we know that centrifugal impulses need not be created in the cord itself, but may be transmitted from the brain. We see this illustrated in the hemiplegias of cerebral origin. We also have equally positive proof that certain sensory impressions are conducted by means of the spinal cord to the brain; hence, centripetal impulses or impressions must pass upward in some instances. We see this fact verified in the hemi-anæsthesia which often accompanies motor paralysis of cerebral origin. Now, it can be stated, with an approach to accuracy, that it is as certainly proved that the *motor impulses* travel along the *anterior half* of the spinal cord, while the path of *sensory impressions* is intimately associated with the *posterior half* of the spinal cord.

<sup>1</sup> This statement is only approximately correct, as will be shown in the text of subsequent pages.

If you will direct your attention, in the second place, to the fact that the motor fibers found in the anterior roots do not decussate<sup>1</sup> until they reach the medulla oblongata, while the sensory fibers found in the posterior roots ascend in the columns of Burdach for a short distance only, when they pass into the gray matter of the opposite half of the cord, we can understand why any interference with the motor fibers (if below the medulla) produces *paralysis on the corresponding side*, while any interference with the sensory roots produces *anæsthesia on the opposite side* of the body.

Again, the *antero-lateral columns* of the cord, which comprise the portion situated between the antero-median fissure and the point of attachment of the posterior roots of the spinal nerves, are not sensible to any form of direct irritation.<sup>2</sup> This is a point of some clinical interest, since, in certain morbid conditions, a marked change in this respect occurs, and the inexcitable portions may then give rise to abnormal sensations and to spasm of the muscles. If these columns be divided, *voluntary motion* is lost in all the parts below the point of section; while, if all the other portions of the cord be divided, leaving the antero-lateral columns intact, the power of voluntary motion remains. The columns of Türck and the crossed pyramidal columns are colored alike in the plate. This indicates a probable similarity of function between these two subdivisions of the cord.

The *gray matter of the cord* seems to be most intimately associated with the transmission of *sensory impressions* to the brain, and that portion which lies in close relation to the central canal of the cord is apparently the most important of the transmittory apparatus.<sup>3</sup> If the entire gray substance of the cord be divided, little or no injury being done to the

<sup>1</sup> As regards this point, Brown-Séquard says: "In animals, there seems to be in the spinal cord itself a decussation of a few of the motor conductors." I do not think, however, that such a decussation can, as yet, be verified in man. If such decussation does exist, it is present only in the *cervical* region, and not in the dorsal and lumbar regions.

<sup>2</sup> The experiments of Vulpian seem to prove that the internal portion of the anterior column does exhibit a trace of excitability in the normal state.

<sup>3</sup> The experiments of Brown-Séquard seem to warrant this conclusion. Very little gray matter may, therefore, suffice to convey all sensory impressions.

white substance, all power of perceiving sensations seems to be destroyed below the point of section. In addition to this function, the gray matter of the cord seems to exert a controlling influence upon the nutrition of muscles and other tissues, since, when the anterior portion becomes the seat of disease, the muscles often undergo atrophy, and occasionally joint diseases develop. This so-called "*trophic function*" is not yet thoroughly understood. Finally, the gray matter of the cord is known to embrace several centers, the two most important of which are the *cilio-spinal center* and the *genito-urinary center*. The former of these is situated in the cervical region, at its lowest part,<sup>1</sup> and exerts an influence upon the pupil of the eye and the skin of the face and neck; hence it is often a valuable guide to determine the height of a lesion in the spinal cord, since the pupils show changes when it is involved that are of value to the diagnostician. The latter center (genito-urinary) is situated in the dorso-lumbar portion of the cord, and often creates symptoms, when disease of the cord exists, referable to the bladder and genital organs. Certain smaller centers, having a vaso-motor function, are described by some authors; but their situation and special functions are either unknown or of little practical utility in diagnosis, while the physiological centers of the cord are, as yet, a matter deserving further investigation before any positive statements can be made concerning them.

In the posterior column of the cord, comprising the columns of Goll and of Burdach, there exists a certain amount of *white substance*, whose function seems to be chiefly to act as *commissural fibers* between certain portions of the spinal

<sup>1</sup> The researches of Waller, Budge, and Brown Séquard would indicate the limits of this center between the fifth cervical and second dorsal vertebræ. It exists in each lateral half of the cord. It presides over the vaso-motor nerves for the vessels of the corresponding eye and side of the face and neck. Vulpian places its limits as low as the fourth dorsal, and Claude Bernard as low as the seventh dorsal, while Schiff carries its limits as high as the medulla itself.

Vulpian's conclusions indicate the *gray matter* of the cord as *positively incapable of excitability*; but he attributes slight excitability to the anterior fasciculi of the cord and great excitability to the posterior columns. In these deductions, he differs somewhat from the results of Chauveau, made, in 1861, upon the domestic animals.

cord. This portion has also some important relation to the *power of coördination* of muscular movement, since disease of this region of the cord is followed or accompanied by disorders of motion, called ataxic symptoms, which are not due to paralysis.

Like the cerebrum, the spinal cord has the inherent power of presiding over certain muscular acts. It is now quite conclusively proven that the automatic acts of walking, standing, swimming, and, to some extent, playing upon musical instruments, dressing, etc., are largely controlled by the spinal cord alone. It is unquestioned that certain of these acts can be made so mechanical that the spinal cord is slowly and painfully educated to perform them without any aid from the cerebrum. It is not generally accepted, however, that the gray matter of the cord has anything to do with the attribute of consciousness.

#### FIBERS OF THE SPINAL CORD.

There are probably three varieties of fibers within the substance of the spinal cord, viz., motor fibers, sensory fibers, and commissural fibers. Each of these has been already mentioned, and some points of general interest pertaining to their situation and function have been given; but there are still some points which must be understood before we are able to intelligently discuss the symptoms of spinal affections.

The *motor fibers* are contained in the anterior roots of the spinal nerves and escape from the substance of the cord in the region of the anterior horns of gray matter. If we trace them from the nerve trunk toward the center of the cord, we shall find that they penetrate the anterior horns, and are in immediate connection with the *prolongations of the motor cells* of that portion of the gray matter. Certain motor fibers can be also traced toward the brain, passing upward in the anterior portion of the white substance of the cord, while prolongations of the motor cells of the gray matter are also found

<sup>1</sup> The cerebellum has also much to do with the coördination of muscular movements. The reader is, therefore, referred to page 64 of this volume.

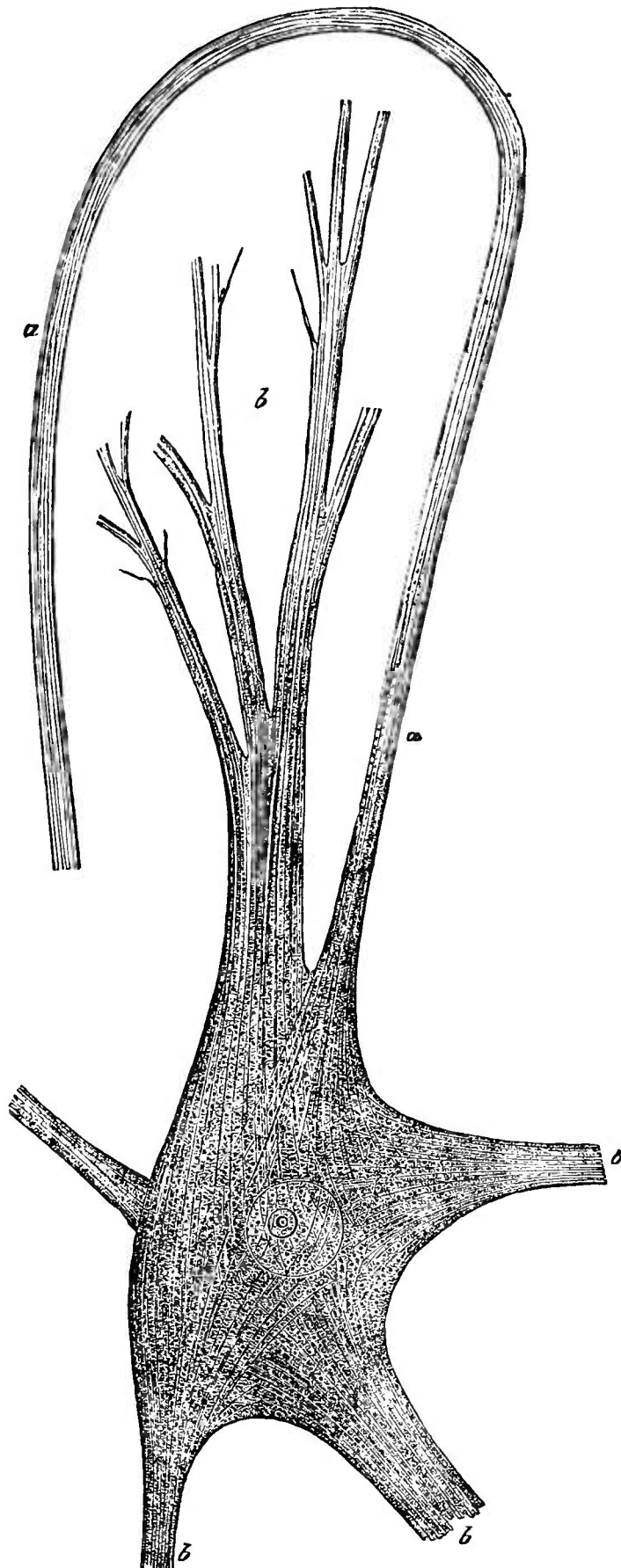

FIG. 117.—Nerve cell from the anterior cornua of the spinal cord of the calf, macerated for a short time in iodized serum; magnified 600 diameters. (Schultze.)  
*a, a*, axis-cylinder prolongation; *b, b, b, b*, branching prolongations.

to be associated with these fibers, which ascend to the brain in the white substance. Now, this connection between the motor fibers and the nerve cells, and the second connection of the cells with fibers going to the brain, would seem to suggest the pleasing hypothesis that the motor impulses are sent first from the brain to the cells of the cord, and from them, through the motor nerves, to the muscles; and that, when the cord is taught to perform certain automatic acts without the intervention of cerebral action, these cells themselves are the exciting organs of the motor impulses (since they are the elements which are most probably concerned in the reflex movements of the spinal cord). We know that the legs of a frog can be made to perform muscular movements after the head has been taken off, by simply stimulating the sensory nerves; and we see the same reflex movements occurring in paralyzed limbs, which are out of the voluntary control of the brain. To explain these phenomena, we must believe that the motor cells of the cord are capable, when called upon, of performing many muscular acts, some of which would seem too complex for spinal control without cerebral assistance, as walking, swimming, playing upon musical instruments, etc. By referring to the diagram,<sup>1</sup> which is shown you upon the blackboard, where a multipolar spinal cell is magnified, you will easily understand how these various poles can be connected with certain motor, and probably, also, with sensory fibers; hence, it can be seen that the cell may receive certain sensory impressions from some poles and send out certain motor impulses to the muscles by means of others, thus accounting for the muscular movements which follow the irritation of sensory nerves.

The *sensory fibers* enter the cord at the posterior roots of the spinal nerves. They are intimately connected with the posterior horns of the gray matter. They probably ascend and descend in the columns of Burdach for a certain distance, and then decussate. The decussation of the sensory fibers is accomplished either by the passing of the fibers themselves to the opposite side of the cord, or by the prolongation of some

<sup>1</sup> See Figs. 117 and 118 of this volume.

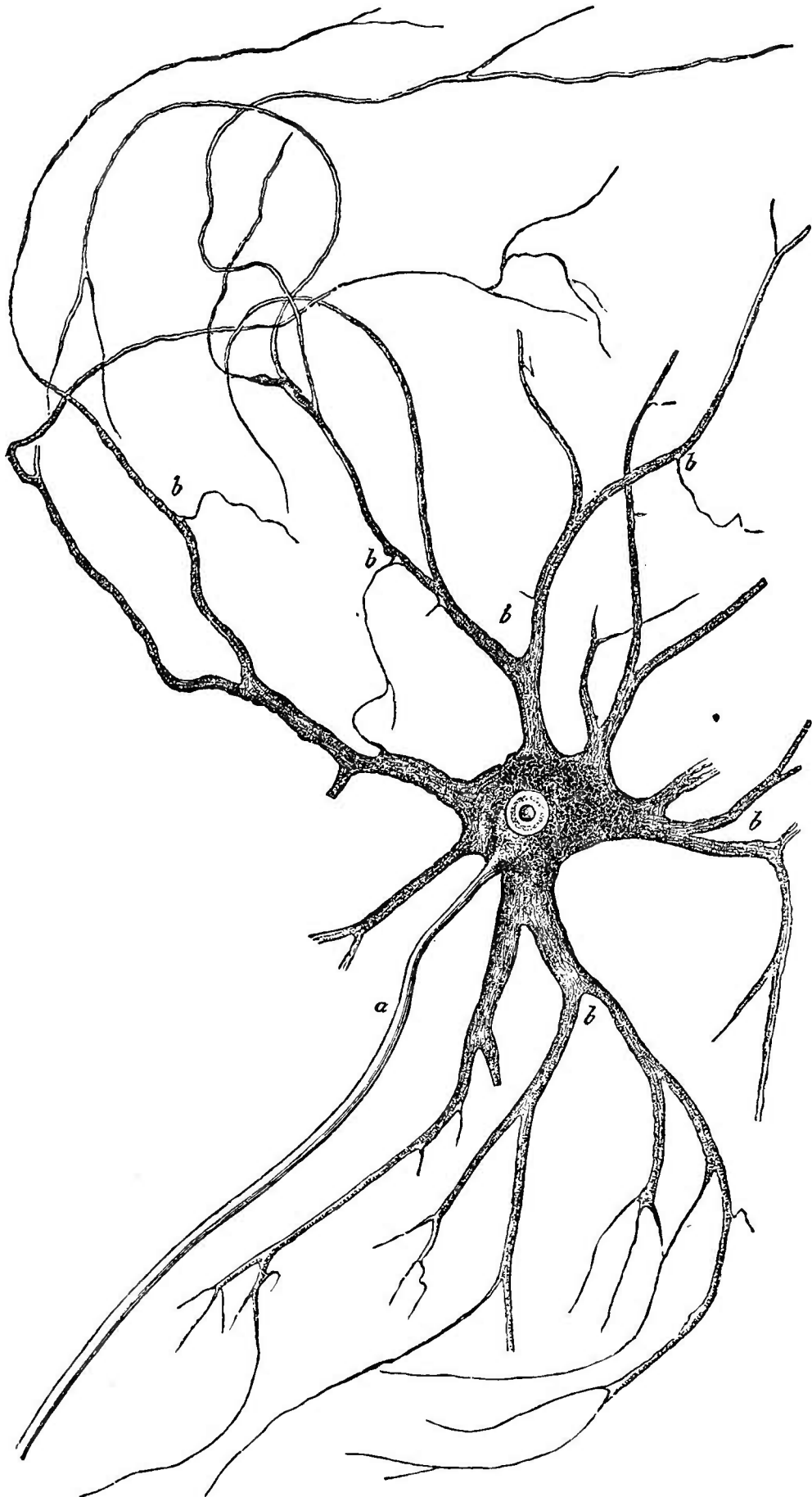

FIG. 118.—*Multipolar nerve cell from the anterior cornu of the spinal cord of the ox : magnified 200 diameters. (Deiters.)*  
*a* axis-cylinder prolongation · *b, b, b, b, b, b*, branching prolongations.

of the poles of the spinal cells into the gray matter of the opposite side. The decussation probably takes place exclusively in the gray matter. While this decussation seems positively proven by all physiological experiment, little of a positive character has, as yet, been shown by actual anatomical demonstration. The sensory nerves are in communication with the cortex of the encephalon, probably, by means of the gray matter of the spinal cord, which acts as a conducting medium for the centripetal impulses. As before mentioned, the gray matter which *surrounds the central canal* of the spinal cord seems to be the chief channel for the transmission of sensory impressions from the trunk and the extremities to the brain. Thus we apparently have in the spinal cord a



FIG. 119.—*Transverse section of the gray substance of the anterior cornua of the spinal cord of the ox, treated with nitrate of silver.* (Grandry.)

conducting shaft, to which the sensory nerves become joined, and which conducts the impressions received through them to the ganglia or the cortex of the encephalon. It is evident, therefore, that the sensory nerves are not continuous



fibers between the brain and the parts to which they are distributed, in which respect they differ somewhat from the motor nerves, whose fibers are indirectly carried to the brain, although the motor cells of the cord are probably interposed.

The *commissural fibers* of the cord probably exist in the white substance of the posterior columns.<sup>3</sup> The spinal cord may properly be considered as a mass of superimposed ganglia; hence, a great necessity exists for certain fibers which shall tend to unite the different parts, and thus conduce to the perfect harmony of action of the whole. It is not possible to demonstrate the existence and exact situation of such fibers, but all physiological and pathological deductions seem to sustain this hypothesis. These fibers have, probably, a most important influence in the proper coördination of muscular movement.

The above diagram illustrates, in a very simple way, the general course of the motor and sensory paths of the spinal cord. The outer lines of the diagram show the general outline of the spinal cord, which merges into the medulla oblongata, above; while the motor fibers are designated by the letter M, and the sensory fibers by the letter S, both where they enter the spinal cord and where they escape from it. This diagram shows that *both the sensory and motor fibers decussate*; but that the motor fibers cross in the medulla oblongata only, while the sensory fibers cross soon after they enter the spinal cord, when they join with the gray matter, and use that as a means of transmitting their sensory impressions to the brain. The diagram also shows that the sensory fibers spring from the posterior roots of the spinal nerves, since the

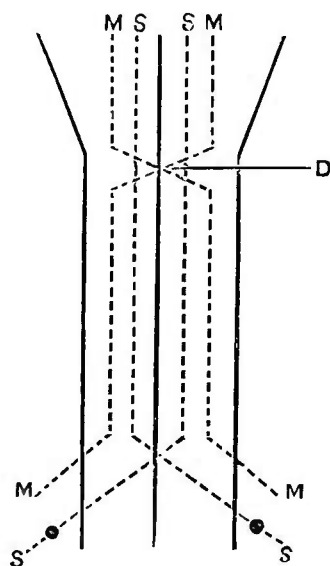

FIG. 120.—Course of motor and sensory paths in the spinal cord. (Brown-Séquard.)

D, decussation of pyramids; M, motor paths; S, sensory paths.

<sup>1</sup> A. Flint, Jr., *op. cit.* The experiments made to prove this point may be found in almost any of the later treatises on physiology.

ganglionic enlargement is depicted upon the sensory fibers as two small black dots. Now, it is easy to understand, by means of this diagram, why any lesion *above the medulla oblongata* must produce all of its symptoms on the side of the body opposite to that of the exciting cause, since the motor and sensory fibers both decussate below that point;<sup>1</sup> while it also shows that any lesion *below the medulla oblongata* must produce motor symptoms upon the same side as the lesion, and, probably, sensory manifestations upon the side opposite to it, since these latter fibers decussate for the entire length

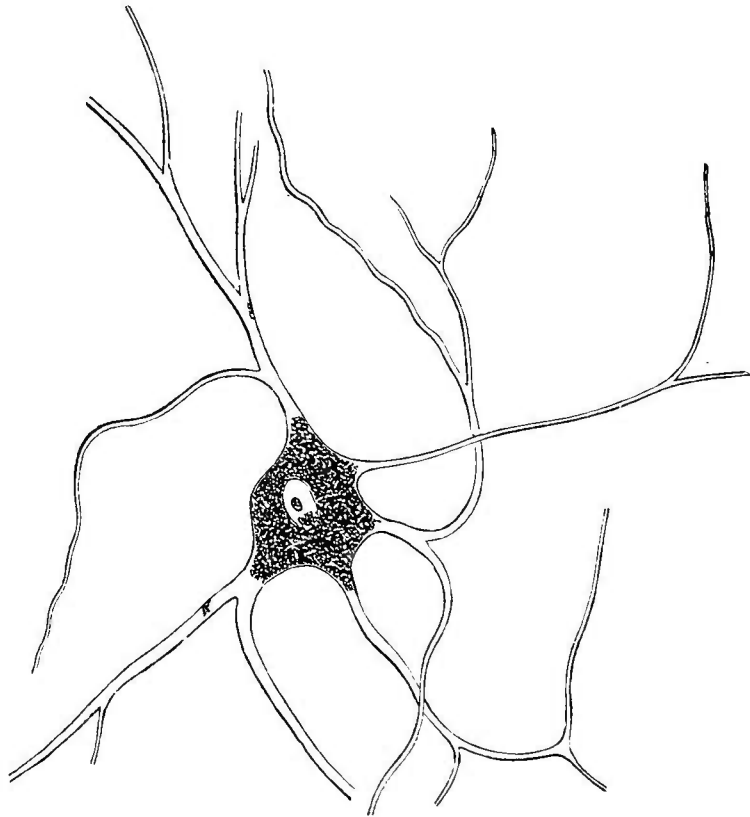

FIG. 121.—Nerve cell from the ferruginous substance which forms the floor of the rhomboidal sinus, in man; magnified 350 diameters. (Kölliker.)

of the spinal cord. In all spinal lesions, causing motor paralysis, the body is affected below the point of disease, since the conducting fibers to the brain are cut off; while, in lesions of the posterior portion of the spinal cord, the nerves of that

<sup>1</sup> This is not absolutely true, as all of the motor fibers do not decussate in the medulla. The reader is referred to page 327 of this volume for the results of the investigations of Flechsig.

region may be rendered incapable of action, but the parts below may be still capable of perceiving sensory impressions, provided that the gray matter is left intact, or sufficient of it remains to act as a conducting medium to the brain.

The *commissural fibers* of the spinal cord are not depicted in this diagram of Brown-Séguard, since little is positively known as to their exact situation or function. As they are probably confined largely to the posterior half of the spinal cord, and as they are also probably intimately associated with the coördination of movement, it is not difficult to see why the symptoms of *anæsthesia* and *ataxia* should march hand in hand, when the spinal cord is diseased in this region; and why *neuralgic pains* should be created by the irritation to the sensory nerves, rather than muscular spasm, which would only exist if the motor nerves were irritated. This general subject will, however, be more fully discussed in connection with the clinical aspects of locomotor ataxia and degeneration of the posterior portion of the cord (the columns of Goll and Burdach).

Finally, two points are especially evident in respect to the nerve fibers of the spinal cord. These may be stated as distinct propositions:

1. The nerve fibers of the anterior roots have less numerous connections with the cells of the gray substance of the cord than are possessed by those of the posterior roots.

2. The morphological distinction between the fibers of the anterior and posterior roots is, that the former are directly attached to the nerve cells by means of their nerve prolongations, while the latter are only indirectly attached to the nerve cells, since they form nerve plexuses before becoming united with the prolongations of the nerve cells.<sup>1</sup>

#### THE SPINAL CORD AS A NERVE CENTER.

If the cord be separated from the brain in a living animal, it may still act as a nerve center, independently of the brain; but, since the spinal cord is then in communication only with

the nerves which arise from it, it can only affect the spinal nerves, and not those of cranial origin. This automatic action of the spinal cord is of a purely *reflex type* under such conditions. It can be demonstrated by exciting some one of the sensory nerves, when a muscular response will be created; hence the term "excito-motor" is often applied to this type of manifestation, whether occurring during life, as the result of disease or peripheral irritation, or after death, as in the physiological experiment alluded to. There are certain acts which are constantly occurring in the body, such as the movements of the pupils, of the intestinal canal, of respiration, etc., which are properly classed as reflex in type, but which are not dependent upon the spinal cord alone. In fact, all acts are classed as belonging to the reflex type, which are the *direct result* of some form of *sensory irritation*; but the term is generally used, in discussing the spinal cord, in its most restricted sense, where the muscular act is purely involuntary, the result of some direct irritation of a sensory spinal nerve, and confined to regions of the body over which the spinal cord exerts a direct influence. Thus, we often see the muscles of a paralyzed limb suddenly thrown into involuntary and unexpected contraction, when a draught of cold air strikes the skin, or when any form of irritation is directly applied to it; while such spasms are common in certain forms of spinal disease which tend to create irritation of the spinal structures, irrespective of any apparent exciting cause.

We have already referred to certain *vaso-motor centers*<sup>1</sup>

<sup>1</sup> The vaso-motor nerves for the trunk, extremities, and abdominal viscera probably originate in the following manner (see researches of Vulpian, Schiff, Cyon, Claude Bernard, and the later researches of Dastre, Laffont, and Morat):

Those for the upper extremities are derived—

1. From the inferior cervical and superior thoracic ganglion, uniting at the brachial plexus, close to the first rib;
2. From the nerve roots of the brachial plexus;
3. From the thoracic cord of the sympathetic, and from the nerve roots of the third, fourth, fifth, sixth, and seventh dorsal nerves, principally from the third and seventh.

Those for the lower extremities proceed—

1. From the spinal cord with the sciatic and crural nerves;
2. From the abdominal cord of the sympathetic.

The abdominal viscera are supplied with fibers arising from a considerable length of

which exist in the substance of the spinal cord, the two most important of which are the cilio-spinal center and the center for the genito-urinary apparatus. The former of these is situated in the cervical region, and exerts some marked effects upon the eye, face, and neck; while the latter is situated in the dorso-lumbar region of the cord. If the medulla oblongata be considered as the upper expansion of the spinal cord (and there are many anatomical reasons for thus considering it), all the centers mentioned as situated in that ganglion may be included among the spinal centers of automatic action. Some authors have gone so far as to locate in the spinal cord certain centers which preside over the acts of micturition, defecation, parturition, erection, etc., and experiment seems to give reason to hope that a more definite ground will be afforded for such belief, although little of a positive character can as yet be given in regard to their situation.

It has also been claimed that the spinal nerves exercise a tonic action over the muscles which move the different portions of the skeleton, in the same way as the vaso-motor nerves exercise such a power over the muscular fibers in the coats of the blood-vessels; and certain experimental phenomena, chiefly the gaping of a wound in muscular tissue, have been advanced to sustain this theory. It is not, however, fully sustained by all the facts,<sup>1</sup> and is not generally accepted by the leading physiologists.

We have come to learn that each group of cells—perhaps each cell—in this gray matter represents a certain kind of intelligence;<sup>2</sup> and that these cells are probably in communication with one another by means of white fibers. It is the sum total of these intelligences that imparts to the cord its characteristics as an organ. As each one of these cellular

the dorsal and lumbar cord, and running within the sheath of the splanchnic nerve, as well as by fibers from the abdominal cord of the sympathetic.

The vaso-motor nerves of the head and face take their origin from what is known as the "cilio-spinal center," and when this center is destroyed there ensues a marked dilatation of the capillaries of the head and face.

<sup>1</sup> For the discussion as to the merits and demerits of this theory, the reader is referred to the late text-book of Michael Foster on physiology.

<sup>2</sup> L. C. Gray, "Annals of Anatomical and Surgical Society," October, 1880.

groups and its inherent intelligence is more or less independent of all others, so the combined intelligence of the cord's gray matter is independent of the combined intelligence of other collections of gray matter; and it is a recognized fact that the spinal cord has a "function" of its own. This has been exemplified by experiments upon headless frogs and decapitated human beings. Cut off the head of a frog, permit it to recover from the shock of the operation, then pinch its skin, and it will hop away; or, throw it into water, and it will swim. Place a drop of acetic acid upon the belly of such a frog, and it will endeavor to brush away the irritation with one foot. Now amputate the leg of this foot at the knee. The animal will make several futile attempts to reach the irritated spot with the stump, and, failing, will, after some hesitation, make use of the uninjured limb for this purpose. It is easy to repeat this well-known experiment of Pflüger's.<sup>1</sup> Robin<sup>2</sup> witnessed some most instructive phenomena in a criminal whose head had been removed an hour previous at the level of the fourth cervical vertebræ. The skin around the nipple was scratched with the point of a scalpel. Immediately there ensued a series of rapid movements in the upper extremity, which had been extended upon the table. The hand was brought across the chest to the pit of the stomach, simultaneously with a semi-flexion of the forearm and inward rotation of the arm—a movement of defense, as it were. All this teaches us the more clearly to understand that it is the intelligence of the cord's gray matter that is called into play in a thousand actions that must take place without the aid of that *conscious* intelligence which we call "mind." The intelligence of the spinal cells is quite sufficient to enable men to walk, to play on musical instruments, to become experts in handiwork, to ride on horseback, whether awake or asleep, to become acrobats, and to unconsciously acquire such a handwriting that its minute peculiarities shall be unerringly recognized by the trained eye.

<sup>1</sup> Pflüger, "Die sensorische Function des Rückenmarks," 1853.

<sup>2</sup> "Jour. de l'Anat. et de la Physiol.," Paris, 1869.

## CLINICAL POINTS PERTAINING TO THE SPINAL CORD.

From the physiological experiments as to the functions of the different columns of the cord, it now seems possible to divide the spinal cord into two great subdivisions, which will be of interest from a purely clinical standpoint, as well as from a physiological aspect. The first of these includes the entire antero-lateral columns, and the anterior horns of the gray matter, and is the probable path of all motor impulses which traverse the cord, as well as the seat of "trophic influences" upon tissues. The latter includes the posterior columns and the posterior horns of the gray matter, and is the probable path of all the sensory impulses, while it also is associated with the function of coördination of movement. Now, both of these subdivisions include several parts of the spinal cord, which have been separately named in previous pages; hence, the term "system" is applied to both, the former being named the "*kinesodic system*," and the latter the "*æsthesodic system*." These names will be constantly used, therefore, when the portions of the cord which convey either motor or sensory impulses are spoken of as a whole; while the other names applied to special portions of the cord will chiefly be used in defining the situations of special lesions whose symptomatology may be under discussion.

If we are to attempt to grasp the symptoms by which the various lesions of the spinal cord may be recognized during life, and to understand why certain effects must be produced (when the situation of the lesion is known to us), we must make some classification of the diseases which affect the spinal cord on such an anatomical and physiological basis as shall naturally tend toward the constant application of these branches of medical science to the symptoms presented by the patient. It has been customary with most of the late authors upon the special subject of nervous affections to consider the diseases of the motor regions and of the sensory regions of the cord separately; using the term "*systematic*

*lesions*” to express the fact that all of those diseases, which are not purely local, affect either the kinesodic or æsthesodic systems. When we speak of systematic lesions, therefore, we mean those types of disease which tend to diffuse themselves, for a greater or less extent, upward and downward, without extension to the adjacent columns; thus the columns of Goll and of Burdach may be involved in the æsthesodic system, the lateral columns and the columns of Türck may be involved in the kinesodic system, while the anterior or posterior horns or central part of the gray matter may be the seat of disease, irrespective of the other parts of the cord.

In contradistinction to the systematic lesions, certain types of disease tend to spread laterally, and thus to involve different columns of the cord in succession. These are grouped under the general head of “*focal lesions*” or “*non-systematic lesions*.” In this form of degeneration, or of new tissue development, the extension is usually limited in a vertical direction, but it may extend, laterally, not only to diverse columns, but may even involve both the kinesodic and æsthesodic systems in its progress.

It will exceed the proper scope of the course of lectures which I have prepared for this winter, to enter into a full description of the symptoms of all of the diseases of the spinal cord; but it is important that you start with a *general classification* of the diseases which may affect this region, in order that you may properly understand the meaning of terms which you will find growing into use with astonishing rapidity. It is also to be remembered that the classification which I have given you is based on anatomy and pathology, and may differ markedly from those of some authors with which you may be familiar; a little study will, however, remove all confusion, and perhaps add to your more perfect comprehension of the subject.



A CLASSIFICATION OF THE DISEASES OF THE SUBSTANCE OF THE SPINAL CORD. (AFTER SEGUIN.)

"SYSTEMATIC" LESIONS.	{	<i>Lesions of the Æsthesodic System.</i>	{	Sclerosis of the columns of Goll,
		<i>Lesions of the Kinesodic System.</i>		Sclerosis of the columns of Burdach (locomotor ataxia),
				Ascending degeneration.
				Sclerosis of the anterior columns,
				Sclerosis of the lateral columns (tetanoid paraplegia),
				Degeneration of the postero-lateral columns,
				Myelitis of the anterior horns (atrophic spinal paralysis),
				Degeneration of the <i>ganglion cells</i> of the anterior horns (progressive muscular atrophy),
				Central myelitis.
"NON-SYSTEMATIC" OR "FOCAL" LESIONS.	{	Traumatism of the cord,		
		Compression of the cord, by	{	Bone or
		Transverse sclerosis of the cord,		Tumors,
		Transverse softening of the cord,		
		Hæmorrhage into the cord,		
Tumors of the cord.				

"SYSTEMATIC LESIONS" OF THE "ÆSTHESODIC SYSTEM."

In the table<sup>1</sup> which I have written out for your inspection, you will perceive that the systematic lesions may affect either the æsthesodic or kinesodic systems of the spinal cord, while the focal lesions are not thus separated, since they tend to extend in a transverse direction, and thus may be found in both. As the æsthesodic system presents only two well-recognized and understood conditions, we will first study the general effects of extending disease which is confined either to the columns of Goll or of Burdach.

We might begin, possibly with advantage, by stating that the general results of any lesion situated back of the posterior gray horn of the cord must manifest itself, if our previous deductions are correct, by symptoms referable only to *sensation* and *coördination*. This we find to be approximately correct. We have in this type of cases *anæsthesia*, *hyperæsthesia*, or *numbness*, and also *pain* (usually possessing some special characteristics which are of clinical value); while *coördination* is unquestionably affected as well, since a peculiar

<sup>1</sup> See page 315 of this volume.

disorder of voluntary movements, which constitutes true "ataxia," is usually developed. Our previous statements as to the path of the motor impulses of the cord seem to be confirmed by the *absence of either spasm or true paralysis* of the muscles below the lesion.

The question now arises, "Can we tell whether the disease is confined to the columns of Goll or of Burdach?" We can undoubtedly locate the lesion in the opposite side of the cord from that of the body upon which certain symptoms are well marked; but can we tell positively whether the lesion is progressing in the inner or outer column of the posterior half of either side of the cord which shows the evidence of disease?

#### SCLEROSIS OF THE COLUMNS OF GOLL.

As regards the columns of Goll, I feel myself forced to say that I do not believe that localized disease can be positively diagnosed when confined to these columns; although, from certain pathological deductions, we can often *infer that it exists*, since it has been found to occur as a secondary result of those other lesions which are capable of producing an ascending or descending degenerative process in the spinal cord. As the columns of Goll are large and distinct in the cervical region of the cord, but become narrower and narrower as the lower portion of the cord is reached, the lesion of this column becomes more evident to ocular demonstration, when present, as you ascend the cord. The entire length of either column may be affected, or only portions of it. In the ascending form of secondary degeneration of these columns, the lesion is always observed above the seat of the exciting cause. This lesion has never been traced, so far as my researches go, above the "calamus scriptorius."

#### SCLEROSIS OF THE COLUMNS OF BURDACH (LOCOMOTOR ATAXIA).

The columns of Burdach are the seat of sclerosis more commonly than those of Goll, since this type of change progresses, as a rule, from the posterior root zones inward, and thus only affects the columns of Goll after those of Burdach

have become seriously impaired. In all those cases where the symptoms of pain and alteration in the sensibility of parts precede those of ataxia, we find the columns of Burdach first affected with a systematic lesion, and, afterward, those of Goll. The investigations of Pierret and Charcot seem to demonstrate that the condition of sclerosis of the columns of Burdach usually begins in the lumbar enlargement, and tends to creep gradually upward toward the medulla oblongata, so that the entire length of the cord may become hardened and atrophied; while the same condition of the columns of Goll is usually found to coexist, but may be looked upon as a secondary result of the former.

Now, we have mentioned certain peculiar symptoms which point, when present, to some disease of the posterior columns of the spinal cord, among which come *pain, hyperæsthesia, numbness, anæsthesia*, and symptoms of *incoördination* (ataxia) when the disease is far advanced. We discover no motor symptoms, as the muscular power appears to be normal in all respects, except in coördinate movement; and no "trophic changes" in tissues are produced, as would ensue if the anterior portion of the cord were involved. It will help us to recognize this disease, if we will study a little more in detail each of these various manifestations of posterior spinal lesions.

In the first place, the *pains* of this type of sclerosis are peculiar. They do not follow the course of special nerve trunks, as do neuralgic pains, but are more localized. They are vagrant in character, since they affect innumerable spots in the region which is presided over by the nerves connected with the diseased portion of the cord; and so marked is this peculiarity that a patient who has long suffered with these pains can not well select any spot which has entirely escaped them. Again, the pains vary in their intensity, since they are more or less paroxysmal, and often show exacerbations due to atmospheric changes.<sup>1</sup> These exacerbations may occur every few minutes for some hours, and may then disappear for

<sup>1</sup> Dampness seems to increase the severity of these pains, thus often tending to mislead the practitioner as to their rheumatic origin.

days or weeks ; the area covered by them may vary from that of a small point to that of your hand ; and they may be referred to the skin alone, the muscles, the joints, the bones, or, in rare cases, to the viscera. These pains are usually of a sudden character, and extremely severe. They assume the character of stabbing, tearing, or shooting sensations, which often cause the patient to shriek in agony ; while the skin over the circumscribed spot is rendered hyperæsthetic to slight pressure, although firm pressure often affords relief. The terms “fulgurating” and “trembling” are often applied to these pains, from their sudden onset and their similarity to the effects of a passage of a strong electric current. In fact, the distinctive characteristics of the pain of sclerosis of the posterior columns of the spinal cord are so well defined that I seldom hesitate to predict the development of later ataxic symptoms from this guide alone. It is usually confined to the lower extremities (toes, foot, shin, calf, and thigh), but it sometimes affects the trunk and the upper extremity, and, in very rare cases, the head. It is to be differentiated from the pain of rheumatism or of a simple neuralgia, and, as it is the initial symptom of a serious and incurable disease, it should be recognized early

Touching upon this point, Professor E. C. Seguin, in a late lecture, puts the diagnosis of this affection, with his accustomed clearness, as follows :

“The only two conditions in which pains somewhat resembling fulgurating pains occur, in my experience, are paralytic dementia and gout. In the former disease, slight fulgurating pains—‘smaller’ pains, if I may be allowed the expression—are described by the patients ; but, in many of these cases, autopsy shows that, besides the cerebral lesions proper to the disease, the posterior columns of the cord exhibit pathological alterations ; so that these cases are, after all, *quasi*-tabetic. The sharp pains of gout are short, stabbing pains in the skin of various parts of the body, compared by the patients to the prick of a needle, cold or hot. There is no tendency to repetition of the pain in one spot for hours or days ; the sen-

sations appear in various parts of the body, and are bearable.

“The differential diagnosis of fulgurating pains from the pains of neuralgia, strictly speaking, is very easy. In neuralgia the pain is in the course and distribution of one or two (single) nerve trunks and their branches; it may be paroxysmal, but does not assume the excessive irregularity of tabetic pains, viz., agony for a few hours, and freedom from pains for hours, days, or weeks. The hyperæsthesia, in fulgurating pains, is at the seat of pain. In neuralgia, we find regular ‘tender points’ along the nerve trunk, or where its branches become superficial. The lightest touch causes pain in the painful districts in tabes, while the tenderness of nerves in neuralgia is usually demonstrable only by firm, localized pressure. Further, true neuralgia is seldom bilateral, while it is the rule for fulgurating pains to appear on both sides of the median line—in both lower extremities, for example. A last important distinction is that neuralgia is relievable or curable, whereas fulgurating pains are practically incurable, and fully relieved only by morphia injections.

“The confusion so often made between ‘rheumatism’ and the first stage of sclerosis is even less pardonable. Of course, no practitioner would mistake fulgurating pains for articular rheumatism; the error is with respect to ‘rheumatism,’ so called, affecting muscular masses and aponeuroses. In these affections the pains are usually dull, nearly constant, and distinctly aggravated by movements. Pressure must be firmly made upon the parts to produce pain, whereas in fulgurating pains the condition is one of cutaneous hyperalgesia under a slight touch. Again, this ‘rheumatic’ condition is distinctly amenable to treatment (counter-irritants, etc.), whereas the pains of posterior spinal sclerosis are, in one sense, incurable.”

Now, this symptom may exist for years without the development of marked anæsthesia or of ataxia, and often both the patient and the physician are inclined to speak of these pains as dependent upon some rheumatic diathesis, rather than as a precursor of an incurable affection. The peculiar

hyperæsthesia which exists in the patches of skin affected with the pain, both during the paroxysm and sometimes for hours afterward, affords a point of great diagnostic value.

As regards the second diagnostic symptom—*anæsthesia*—it is claimed that an alteration in the sensibility of the affected parts can be detected in the earliest stages of the disease, as well as later on ; but, in the former case, the loss of sensation is localized in distinct spots or patches of integument (usually upon the lower extremities, but, possibly, upon the trunk and arms, if the disease be extensive), while, in the later stages, the soles of the feet become deprived of sensibility, and the anæsthetic condition tends to extend upward along the legs and thighs until the whole of the affected regions may be dead to all sensations. Now, it is this very condition of the integument that probably causes the symptom which is regarded by many physicians as pathognomonic of locomotor ataxia—staggering or falling, when the eyes are closed and the patient attempts to stand erect—and no test is more worthless of this special affection. I have seen a patient made to fall, when his eyes were closed, by simply freezing the soles of the feet so as to render them incapable of sensation, while it is well recognized that the same symptom is met with in the anæsthesia which follows or accompanies hysteria, myelitis of the posterior horns, etc. That patients afflicted with locomotor ataxia do stagger and often fall, when obliged to stand erect with closed eyes, no one can deny, but that it has no special diagnostic value can now be as positively stated.

In the final stages of sclerosis of the posterior columns, *symptoms of ataxia* develop. The walk of the patient now becomes of a peculiar character. The legs are jerked about in an aimless manner, and the feet are brought down in a stamping way which is totally different from the gait of paralysis.<sup>1</sup> The separate muscles, when tested, show an unim-

<sup>1</sup> This symptom may develop at a variable period from the commencement of the neuralgic pains (the duration of the pains varying from three months to ten or more years). The heel strikes the ground forcibly in walking. If the upper extremities are involved, the fingers and arms perform unnecessary movements to reach a given point, and oscillate when a given action is attempted.

paired power, but the large groups of muscles can not be employed in rhythmical succession. The patient begins to notice, in the early symptoms of this condition, a sense of distrust in himself in crossing a street or in performing any act which calls for sudden and positive muscular coördination. Later on, walking becomes almost impossible if the ataxic symptoms develop rapidly, and the patient is liable to fall, in his efforts to avoid any special danger, as in traveling the streets.

One of the earliest evidences of incoördination of movement usually perceived by tabetic patients is a difficulty in directing their feet toward any object of small size, such as a carriage-step, stirrup, etc. A difficulty is also experienced by many in ascending long flights of stairs, as the equilibrium is preserved with some difficulty, on account of an uncertainty in placing the feet upon the stairs. Later on in the disease, the feet are swung in a circle, in contrast to the straight progression of the normal step, since the equilibrium is thus more easily preserved. This has been compared to the swinging motion of the tight-rope performer. The sole of the foot is generally brought down after the heel strikes the ground, thus often giving a flapping sound to the step. The jerking gait of well-marked ataxia could never be mistaken for that of paralysis.

When the upper extremities are affected, the motions of the hand show even more decided evidences of incoördination. Such patients, when asked to place the tip of their finger upon any designated spot on the face (provided the eyes are first closed, in order to prevent the use of vision as an aid to movement), utterly fail to perform the act, often touching a spot one or two inches from that upon which they intended to place their finger. With the eyes open, a glass of water is carried to the mouth with a trembling of the hand and partial spilling of its contents; and the finger is placed upon any point designated upon the face by being suddenly darted forward, rather than by a deliberate movement. The handwriting is markedly altered, especially in respect to the

rounded letters, such as *d, b, o, c, z*; and this is even more marked when writing is attempted with the eyes closed, as it is then almost unintelligible.

The complex movements of the fingers, required for the act of buttoning or unbuttoning the clothing, and in picking up a pin from the floor, are performed with so much difficulty that they afford two admirable tests for this disease, provided the upper extremity be involved.

Tabetic patients usually walk with their eyes fixed upon the feet, as vision aids them materially in guiding their movements of progression; hence, we invariably find that closing the eyes causes a marked alteration in the ataxic manifestations, oftentimes causing them to fall when required to stand motionless.

It must be remembered, however, as was brought out in the lectures upon the brain,<sup>1</sup> that certain forms of intra-cranial diseases tend to produce the same symptoms, so that ataxic movements are only confirmatory of a spinal disease which has previously manifested itself by well-marked sensory symptoms.

There are two other symptoms referable to the sensory nerves which are of value in deciding as to the probable existence of posterior spinal sclerosis, viz., a *retardation of sensation* and *diminished reflex movement*.

If we prick the skin of a patient suffering from this type of disease, and count the time which intervenes between the time of the puncture and the time when the patient perceives it (provided the eyes be closed, so as to prevent any visual recognition of the pricking of the part), we will often find that an interval, varying from ten to one hundred or more seconds, may be detected. This has been explained, by supposing that the sclerosis has created such pressure upon the sensory nerve filaments as to partially or nearly completely destroy the axis cylinders. This symptom is invariably followed sooner or later by complete anæsthesia, and by a sense of numbness which extends upward from the feet,

<sup>1</sup> See pages 64 and 65.



since it is usually perceived in the lower extremity rather than in the upper.

In addition to the sensory manifestations already discussed, this disease tends to extend upward along the cord until the optic apparatus becomes, in some way, markedly affected. The perception of color is often rendered obscure, or entirely lost for the red and green tints; while the patient may possess a normally acute perception of the yellow or blue tints, or even have an unnatural acuteness in detecting delicate shades of these colors.

In some instances, ptosis, diplopia, and a marked alteration in the reflex movement of the iris to varying degrees of light, are developed; and these may prove of great advantage to you in tending to confirm the possible existence of this type of spinal sclerosis.

During the first stage of the disease, when the fulgurating pains are present, all the reflex movements which seem to be controlled either entirely or in part by the spinal cord are diminished. As examples of this fact, we frequently see that the pupils are either smaller than normal, or irregular as regards their size, or that they do not properly respond to fine variations in the intensity of light,<sup>1</sup> and that the muscles do not respond to sensory stimulation of the skin. If the knee be semi-flexed during the stage of fulgurating pains, or even when the ataxic symptoms have been developed, and the ligamentum patellæ be struck sharply with the finger-end, you will notice that the muscles of the quadriceps extensor of the thigh fail to produce any responsive movement of the limb, since the reflex action of the spinal cord is impaired. This test is one which is now regarded by specialists in nervous diseases as one of great value, in deciding as to the presence of posterior spinal sclerosis, and it is known as the "patella reflex" test.<sup>2</sup>

<sup>1</sup> See page 148 of this volume.

<sup>2</sup> In reference to the diminution of the different reflexes, much has already been mentioned in preceding pages. I quote, however, a summary of Professor Seguin upon this point, as a general *résumé*.

"We test the so-called patellar reflex, or knee reflex, or patellar tendon reflex, in the

Now, it must be evident to you all, that the symptoms which have been hastily enumerated as indicating a lesion in

following ways: the patient, being seated, is told to cross one leg over the other in a natural manner, and to let the muscles relax; or, seated, we place our left hand under the popliteal space, tell the patient not to help us, to let the leg hang loose, or, in popular parlance, 'dead,' and lift the whole limb so that the foot swings a couple of inches above the floor; then we tap the skin over the whole of the region from the insertion of the quadriceps femoris to the tuberosity of the tibia, with one or two finger-tips applied as in percussion. The place whence a reflex quadriceps contraction is most apt to occur is about midway between the lower end of the patella and the tibial protuberance. The taps should be gentle at first, and, if these fail, harder ones are to be tried. A third mode of procedure, which is very good indeed, is to seat the patient on a table so that his legs dangle some two or three inches beyond its edge; then we tap the patellar region as above described, without supporting the thigh with our left hand. The test may be well done through the patient's clothing, yet it is desirable, especially in doubtful cases, to tap the bare skin. Another important precaution is to secure the absolute relaxation of the patient's muscles, and to divert his attention from what you are doing. Even with all precautions, it is sometimes next to impossible to secure this indispensable muscular relaxation. In the healthy subject this test develops a contraction of the quadriceps extensor femoris, and causes an extension of the leg or a sudden jerk. In a very early stage of posterior spinal sclerosis no contraction takes place.

"I would also call attention to the occasional occurrence of reflex movements of the thigh, produced by contraction of the iliac group of muscles during the knee test. I have an example of this distant reflex action in a typical case of sclerosis of the posterior columns, in which the quadriceps does not contract at all.

"While claiming very great diagnostic value for this negative symptom, I would not be understood as attaching pathognomonic significance to it, as we all know that there are a few seemingly healthy individuals in whom the patellar tendon reflex is lacking, and also that there are other diseases which diminish or abolish it. Indeed, I may say that I recognize no pathognomonic symptom, and, even in attempts to push diagnosis to an extreme delicacy, would urge that reliance be placed on the grouping of symptoms, rather than on any one of the signs, however constant and important it may appear.

"Physiologically analogous to this condition of loss of tendinous reflexes is the flabby state of the muscles in the affected parts. This is not due to any positive atrophy, as electrical tests show us marked departure from the normal reactions, but to impairment of what physiologists call muscular tonus—a state of partial contraction or tension of muscles, which is kept up by the inevitable and continued excitation of the cutaneous nerves by air, clothing, surrounding objects, etc., acting in a reflex way through the spinal cord. It has been recently claimed that this loss of muscular tonus was the most important factor in the production of the ataxic movements which characterize the second stage of the disease.

"The vesical and rectal reflexes are diminished in posterior spinal sclerosis. Slow, irregular micturition is complained of by most patients, in the first stage and in the second. We usually micturate without using much volition, but the tabetic patient is obliged to strain and to try hard to pass water. Defecation is, like micturition, a semi-voluntary act, and in the late first stage of the disease in question constipation becomes more and more marked, and that through loss of the automatic or reflex action of the rectum and adjacent muscles.

"The sexual act is, in my experience, frequently impaired and sometimes almost lost before the second stage sets in. The acts of erection and emission are usually brought about in a reflex manner by irritation of the skin and mucous membrane of the genitals. As a result of diminished spinal reflex action we have imperfect erections, and either

the posterior columns of the spinal cord have sustained the physiological experiments and deductions as regards the probable function of these parts. We have found that *sensation* is affected in various ways and degrees; that *coördination* of muscular movement is interfered with in the advanced stages of the destructive process; and, finally, that the *reflex function* of the spinal cord is impaired, when the sensory nerves become incapable of properly transmitting their impulses to the motor cells of the cord.

Several theories have been advanced to explain the development of ataxic symptoms, all of which will help to fix some anatomical point, previously mentioned, forcibly in your memories. These theories may be thus enumerated:

1. That the destruction of the *commissural fibers* which connect the different segments of the cord causes ataxia.

2. That the *tonic action*, which is claimed to be normally exerted by the spinal cord upon the muscular tissues of the body, is impaired; hence, a certain unnatural relaxation of some parts exists, which induces irregularity of muscular movements.

3. That the condition of anæsthesia, which is probably present in the muscular tissues as well as in the skin, destroys the so-called "*muscular sense*"; hence, the patients can not properly guide the contractions of muscles.

#### "SYSTEMATIC LESIONS" OF THE "KINESODIC SYSTEM."

As has been stated in the anatomical description of the spinal cord, the kinesodic or motor regions of the cord include

premature emission, or, what is more common, I believe, very slow production of the orgasm, and impossibility of repetition within a reasonable time.

"Some writers admit abnormally great sexual power in the early stage of tabes, but I am not sure to have met with more than one or two cases in which this seemed to be the case. In one of the patients, a female, I became convinced that her extraordinary capacity for sexual intercourse was not in a strict sense pathological or pre-tabetic, but had been marked in one shape or another from childhood.

"It seems reasonable at the present time to advance this general proposition: that, in posterior spinal sclerosis, the various reflex actions performed by means of those portions of the cord which are the seat of sclerosis are diminished or lost; or, to put it in another way more useful for practice, it may be said that the limitations of loss of reflex action in different parts of the body accurately indicate the limits of sclerosis in the posterior sensory apparatus in the spinal axis."

the columns of Türck<sup>1</sup> (called also the “direct pyramidal fasciculi”), the anterior root zones, the anterior portion of the lateral columns, and the posterior portion of the lateral columns (called also the “crossed pyramidal fasciculi”). As indicated in the table of diseases of the spinal cord,<sup>2</sup> several distinct and separate affections of these component parts may exist, each of which presents some symptoms which are specially diagnostic.

When we review the points mentioned as to the functions of the kinesodic system, we should expect to find that any lesion confined to the regions designated above would be manifested by disturbances in the *motor functions* of the body and by certain “*trophic changes*”; while we would also expect to find an absence of any disturbance in the sensory nerves or in the coördination of movement. This is fully confirmed by clinical experience. In all lesions of the kinesodic system, we are apt to meet either muscular spasm, muscular atrophy, or motor paresis, or paralysis; but we are never confronted with fulgurating pains, numbness, or anæsthesia, provided the posterior columns (the æsthesodic system) be not simultaneously involved. In order to appreciate the points of diagnosis of the different forms of systematic lesions which may affect the anterior half of the cord, it will be necessary to discuss, in a general way, the special symptoms of each.

#### SCLEROSIS OF THE COLUMNS OF TÜRCK.

The columns of Türck (“the direct pyramidal fasciculi”) are affected with sclerosis, either separately and alone, or in connection with similar changes in the postero-lateral columns (“the crossed pyramidal fasciculi”). What its producing causes are is, as yet, not thoroughly understood. We simply know, from pathological investigation, that sclerosis of the

<sup>1</sup> See page 298 of this volume.

<sup>2</sup> Türck may be justly considered as the pioneer in the investigation of *systematic spinal lesions*, since, as early as 1851, he recognized sclerosis of the motor columns of the cord and the crossed effect of brain lesions upon the motor columns. Much valuable research has since been performed by Vulpian, Bouchard, Flechsig, Seguin, Charcot, and others.

two portions of the kinesodic system mentioned is liable to occur simultaneously, although they may be individually affected. We also know that disease of the motor tract of the crus, above the decussation of the motor nerves in the medulla, as well as lesions in the nucleus caudatus, the internal capsule, the lobulus para-centralis, and the motor regions of the cortex, often causes what is termed "secondary degeneration" throughout the motor tract of the spinal cord for its entire length; hence, this condition of the motor columns may be the late result of some preceding brain lesion, and is often confined to one lateral half of the cord (most commonly on the half opposite to the seat of the exciting lesion in the brain). The accompanying diagram, which illustrates the course of the fibers in the medulla oblongata, will explain why the symptoms produced by descending degeneration of the motor columns of the cord are not always present upon the opposite side of the body to that of the brain lesion which produced it, since it shows that some of the fibers of the cord do not decussate.

This diagram shows that the fibers of the medulla decussate before entering the spinal cord, for the most part,<sup>1</sup> but that a certain proportion of the fibers pass in a direct line from the encephalon to the cord. The figures (shown at the bottom of the diagram) indicate the relative proportion

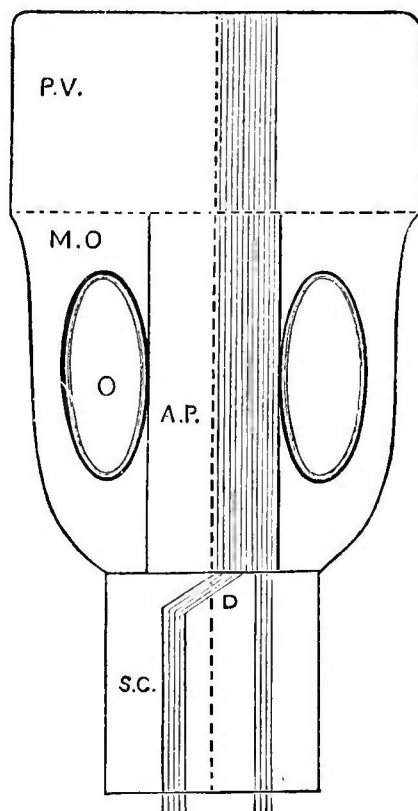

FIG. 122.—A diagram to show the decussation of motor nerve fibers in the medulla oblongata. (After Flechsig and Seguin.)

P. V., pons Varolii; M. O., medulla oblongata; O, olivary body; A. P., anterior pyramid; D, decussation; S. C., spinal cord. The direct and crossed bundles vary very much in size, as shown in the following ratios of crossed and direct: (100 : 00), (92 : 8), (84 : 16), (70 : 30), (52 : 48), (35 : 65), (10 : 90).

<sup>1</sup> Much of our present knowledge upon this point is due to the researches of Flechsig in 1867, and to those of Bouchard in 1866, made in connection with Vulpien and Charcot.

between the direct and the decussating fibers, which have been found in different instances. Now, as this "secondary degeneration" (caused by lesions of the encephalon) follows the individual nerve fibers, the effects would be manifested, for the most part, upon the *opposite side* of the body, since most of the fibers decussate; but some nerve fibers, which do not decussate, would be impaired on the *same side of the spinal cord* as the existing brain lesion. Thus we are enabled to explain spinal symptoms on *both sides of the body*, when preceded by a cerebral lesion; although the spinal manifestations are usually detected on the side opposite to the exciting cause. The varying proportion of these direct fibers to those which decussate will explain why this secondary degeneration may be followed by symptoms confined entirely to one side of the body, or, again, affecting both sides.

You are probably wondering how it is possible to tell when this slowly progressing degeneration of the columns of Türcck, or of the postero-lateral columns,<sup>1</sup> is present. When an attack of hemiplegia has occurred, you have probably been able to decide early whether it is of cerebral or spinal origin; since, if cerebral, it will probably affect the side of the body opposite to the seat of the lesion within the brain, and other points in the history will probably confirm this as the exciting cause. Some time after the attack of hemiplegia, however, you will notice that the paralyzed muscles are becoming more or less rigid, and that a *state of contracture* is developing. Now, it is this point in the case that should indicate to your minds the fact that a progressive descending degeneration of the spinal cord is taking place, and you can safely expect to find sclerosis of the anterior and postero-lateral columns at the autopsy.

In some cases the contracture of paralyzed muscles, after an attack of hemiplegia, is accompanied by an *atrophy* of the paralyzed and rigid muscles; so that their volume becomes much more extensively impaired than would ensue from sim-

<sup>1</sup> Our present knowledge leads us to infer that the anterior and lateral columns possess a similarity of function.

ple disuse. In this event, you may be justified in suspecting that the *anterior horns of the gray matter* of the spinal cord are becoming diseased, a condition to which the term "polio-myelitis," or "myelitis of the anterior horns," may be found applied in treatises upon nervous diseases. This will be considered in detail in a subsequent lecture.

SCLEROSIS OF THE LATERAL COLUMNS ("TETANOID PARAPLEGIA"—  
"SPASMODIC TABES").

The lateral columns (including the whole of the mass of white substance found at the sides of the spinal cord) may be diseased, either as a primary lesion, following cold, dampness, over-exertion, and syphilis, or as a part of a secondary morbid process (chiefly in connection with polio-myelitis). In 1875 the name of "spastic spinal paralysis" was applied to this condition by Erb,<sup>1</sup> and in 1876 Charcot<sup>2</sup> described it under the head of "spasmodic tabes." You will, therefore, find it described under both of these names, although I prefer the name, applied to it by my friend Professor Seguin, "tetanoid paralysis or paraplegia," since to the common mind it best conveys the idea of its symptomatology.

As this lesion is often combined with myelitis of the anterior horns of gray matter, as mentioned above, and since such degeneration of the anterior horns is apt to affect the "trophic function" of the cord, Charcot has applied to this complex systematic affection of the cord the term "amyotrophic lateral sclerosis." A peculiarity of sclerosis of the lateral columns of the cord, whether complicated with disease of the anterior horns or not, is that *both sides* of the spinal cord are nearly always involved at the same time; hence, the occurrence of *paraplegia* is more strongly diagnostic of this affection, provided other symptoms of value exist, than if hemiplegia be present. I shall use the term "tetanoid paraplegia," therefore, in preference to the other names suggested by the authors quoted, in describing the symptoms which are diagnostic of this affection.

<sup>1</sup> *Op. cit.*

<sup>2</sup> *Op. cit.*

When the sclerosis of the lateral columns affects the *cervical enlargement* of the spinal cord (where the nerves to the upper extremities are given off), the symptoms appear first in the hands. The affected parts have a peculiar sense of formication, like the creeping of ants over the part. They undergo rapid atrophy (if the anterior horns are affected<sup>1</sup>), causing the hands to become bony from disappearance of the interossei muscles, and the parts become simultaneously paralyzed. Soon a contracture of the paralyzed muscles develops, producing the so-called "claw-hand deformity." The lower limbs become at first paretic, but gradually develop a paralyzed and contracted condition; although the contracted state of the muscles is very much more apparent when the patient stands and attempts to walk than when lying in bed, since the rigidity almost disappears when in the recumbent position. If the lesion extend upward to the region of the motor bulbar nerves, the symptoms of glosso-labio-laryngeal paralysis<sup>2</sup> may be developed, in addition to the other symptoms described. The muscles of the legs do not generally waste, and the bladder and rectum are not, as a rule, paralyzed. No evidences of anæsthesia can be usually discovered in the regions affected.

In tetanoid paraplegia, there is a marked *increase* in the *reflex excitability* of the affected parts. It is to this increase in all the reflex movements that the peculiar gait of this class of patients may be attributed. Thus, the increased action of the adductor muscles tends to make the legs almost cross each other in walking;<sup>3</sup> the excessive action of the muscles of the calf raises the heel, and the legs move with a stiffness which makes a contrast with the normal act of walking. In the last stages of this affection, when the patient becomes bedridden,

<sup>1</sup> A complex condition, termed by Charcot "amyotrophic lateral sclerosis." The patient at first walks with a cane, then with crutches, and later on requires an attendant.

<sup>2</sup> The symptoms of this affection (Duchenne's disease) have been given in detail in connection with the hypo-glossal nerve. The reader is referred to page 279 of this volume.

<sup>3</sup> When both the lower limbs are affected by lesions of the lateral columns of the cord, the legs frequently become interlocked at every attempt to walk.



the increased reflex excitability causes the legs to become semi-flexed and adducted, and the muscles are sensibly hardened. It is a clinical point of some value that the muscles affected with tetanoid paraplegia retain their normal size, nutrition, and electrical reactions (provided that the anterior horns are not diseased). This condition is quite commonly met with in children ;<sup>1</sup> and the little sufferers can not often stand or walk, from the spasmodic action of the muscles of the legs. In adults, as a further evidence of the increased reflex excitability of parts, the act of passing the urine or fæces becomes one which requires the patient to hurry with all possible speed, in order to avoid a sudden and involuntary evacuation.

Now, the absence of anæsthesia, of numbness, and of fulgurating pains, will easily assist you to diagnose between a case of disease of the posterior columns and that of the lateral columns of the cord, although the peculiarity of gait may for a while confuse you. The increase in the "patellar reflex"<sup>2</sup> and the actual loss of power of individual muscles will also assist you in the diagnosis ; while in tetanoid paraplegia the muscles are stiffened, especially when standing or walking, sensations are not delayed, and coördination of movement is normally performed.

MYELITIS OF THE ANTERIOR HORNS ("ATROPHIC SPINAL  
PARALYSIS").

As shown in the table<sup>3</sup> of diseases which may affect the kinesodic system of the spinal cord, the anterior horns of gray matter may be the seat of degeneration. As in all other lesions of the motor tract of the cord, the symptoms of this affection are confined to motor phenomena, and characterized by the absence of sensory effects (anæsthesia, numbness, etc.); but, in addition to the motor phenomena, certain *tro-*

<sup>1</sup> These children are often microcephalic or idiotic; hence the symptoms may be due to an incomplete development of the motor tract of the spinal cord. It is stated by Seguin that circumcision can not be considered as a curative measure in all cases, since Jewish children, circumcised at birth, have been frequently seen by him with typical evidences of this disease.

<sup>2</sup> See page 323 of this volume.

<sup>3</sup> See page 315 of this volume.

*phic changes* become prominently developed, which are of special value to the diagnostician.

In this lesion we find, after death has occurred, that the motor cells of the cord have undergone atrophy (due, probably, to an acute inflammatory degeneration associated with pigmentation of the parts), and that the anterior roots of the spinal nerves have likewise undergone a fatty metamorphosis. The condition may be of three distinct types, which are called the acute, sub-acute, and chronic varieties, and each presents certain characteristic symptoms. The term "*polio-myelitis*" is frequently used as a synonym for this change in the anterior horns.

The acute form is manifested by the presence of a fever, either of the continued or remittent type, which is usually accompanied by pains and a sense of numbness in the limbs. As the fever subsides, usually in the course of several days, an *extensive paralysis* is suddenly developed. This paralysis may affect both arms and both legs, the legs alone, or, possibly, only one of the four extremities; it may occasionally be a hemiplegia, if one side of the cord is alone involved. In a longer or shorter space of time, this paralysis gradually diminishes; the bladder and rectum remain unimpaired throughout the attack of paralysis; no anæsthesia or numbness can be detected in the paralyzed parts; and there is no tendency to the development of bed-sores. If you test the paralyzed limbs for reflex movements, you will usually find them totally abolished. If you apply the faradic current, the muscles will fail to respond; but, when the constant current is used, you will notice a slow contraction, and certain variations in the usual formulæ of galvanic reaction will stamp the condition as one of degeneration.<sup>2</sup> What these formulæ are can be

<sup>1</sup> This is not always the case, as the reflex movements are oftentimes only decreased in frequency and force.

<sup>2</sup> "Remarkably distinct evidences of the degenerative reaction to electricity are obtained from the second to the tenth week. The nerve trunks supplying the paralyzed muscular groups lose their excitability to faradism and galvanism, and these wasting muscles react only to galvanism, and their reaction formula is altered from the normal; in general terms, we may say that  $An\ e\ e = ka\ e\ e$ , or even  $An\ e\ e > ka\ e\ e$ ; and all contractions are slow and wave-like." (E. C. Seguin, "Med. Record," 1878.)

easily found in any of the special treatises on the treatment and diagnosis of nervous affections. Now, in this type of myelitis, you will not have to wait long to decide as to its character. In a few days or weeks the muscles of the paralyzed limbs will show a rapid wasting, since the muscles are undergoing atrophy; and this wasting is markedly progressive, since the change in the muscles continues to extend until a most characteristic and permanent deformity results, provided that recovery does not occur.

This condition of the cord is frequently associated with sclerosis of the lateral columns; hence, it is not infrequent to observe a state of contraction in the paralyzed muscles, which lasts in a varying degree, until the atrophy of the contracted muscles destroys their power of producing deformity. These contractions are not inevitably permanent, if present in the

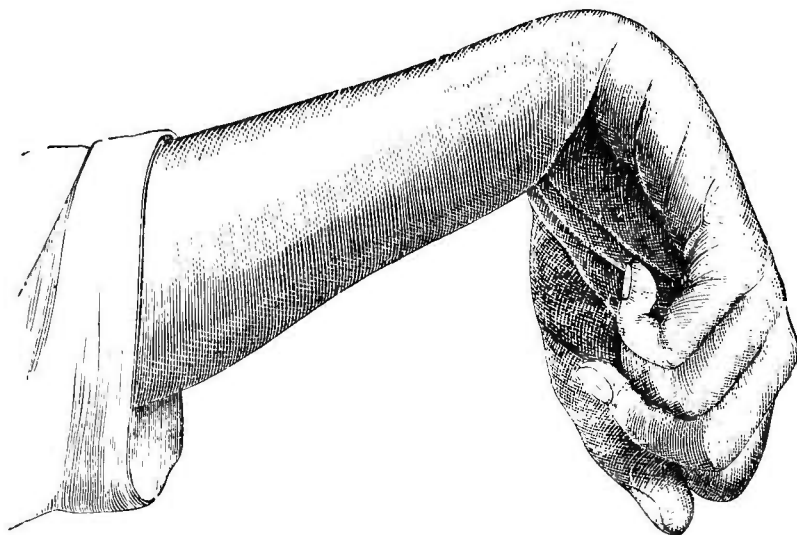

FIG. 123.—*Atrophic spinal paralysis, with contracture.* (Hammond.)

early stages of the disease, as they may totally disappear in exceptional cases; but they usually return with increased deformity as the disease progresses.

In those cases of so-called “infantile spinal paralysis,” and in similar cases affecting the adult, a *non-febrile variety* of this affection may be met with, where the disease begins with no initial symptoms, but where the paralysis and all subsequent symptoms mentioned above are developed suddenly.

The *chronic form* of myelitis of the anterior horns is seldom to be diagnosed from progressive muscular atrophy. It is claimed that the severe neuralgic pains which accompany the wasting process of the former are diagnostic between the two affections, and that the degeneration of the affected parts does not assume the *fibrillary* or *fascicular* character of true progressive atrophy, dependent upon changes confined to the ganglion cells of the spinal cord, but the distinction is, in my experience, a difficult one.

The condition of polio-myelitis tends, as a rule, to progress upward along the spinal cord, and thus often reaches the medulla oblongata. The symptoms which are then produced include those of paralysis and atrophy of the tongue, difficult deglutition, impairment of speech, and a nasal quality of the voice, due to the paralysis of the soft palate. The expression of the face is greatly altered by paralysis of the orbicularis oris muscle, which creates an apparent increase in the width of the mouth; and, after laughing or weeping, the mouth remains open for an unusual period, and thus favors the escape of saliva.

PROGRESSIVE MUSCULAR ATROPHY (DEGENERATION OF THE GANGLION CELLS OF THE ANTERIOR HORNS).

Degeneration of the *ganglion cells* of the anterior horns of the cord is pathologically distinguished from the condition just described, since the results of the former were of an inflammatory character, while the latter is a purely degenerative process of primary origin. The former was rapid in its effects; this disease is slow, since the ganglion cells undergo molecular disintegration. We may expect to find, at the autopsy of such a case, the cells changed into a granular condition, and more or less destroyed; while, in extreme cases, the anterior horns of gray matter of the affected part may be utterly destitute of these cells.

It is this pathological change that creates the train of symptoms called "progressive muscular atrophy." The muscles, supplied by nerves connected with the seat of degener-

ation, begin to show a slowly developing atrophy of certain fibers or bundles, while other parts of the muscle may appear perfectly normal; thus it may take months for an entire muscle to become completely wasted, the muscle showing during its contraction the gradual atrophy of certain parts. This disease seems to exist most commonly in the muscles of the hand, thighs, and chest, and a symmetry<sup>1</sup> in its development is a characteristic feature. It is seldom associated with any sensory symptoms. In the rarest cases will you be able to detect the existence of pain;<sup>2</sup> and symptoms of anæsthesia are wholly absent. Another point which will assist you in diagnosis is the *absence of paralysis*; although the affected muscles may show a loss of power in proportion to the actual destruction of muscular tissue. If you apply the faradic current to the affected muscles, you will find that they respond to its influence in exact proportion to the extent of the degeneration, so that the unaffected fasciculi will be thrown into contraction. This is in marked contrast to the effect of the faradic current upon the muscles in the case of myelitis of the anterior horns, where the muscles failed to respond in their entirety, even before they showed any evidence of atrophy.

The muscles which are undergoing the early changes of

<sup>1</sup> The atrophy affects parts which are not only *symmetrical*, but *homologous*. It is common to see both shoulders simultaneously atrophied, or the arms and thighs, or the forearms and the legs.

<sup>2</sup> Hammond states that *pain is perceived after exertion*, but he attributes it to muscular fatigue rather than to central causes.

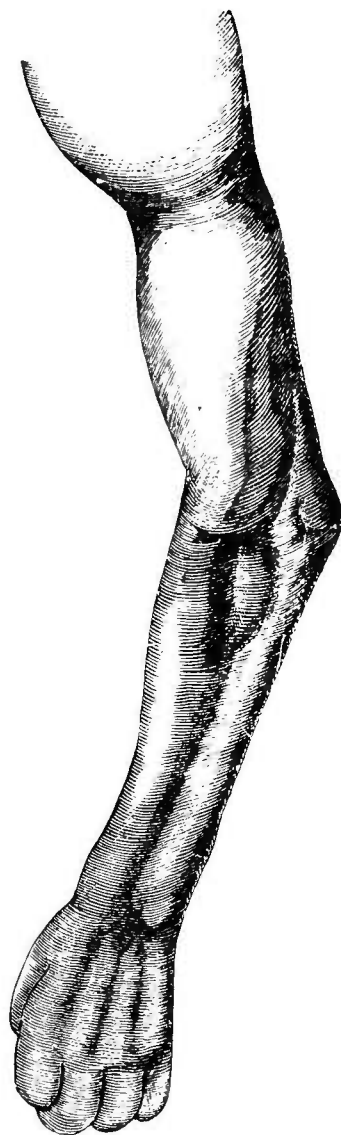

FIG. 124.—*Progressive muscular atrophy of upper extremity.* (Hammond.)

this wasting are the seat of what are called *fibrillary contractions*.<sup>1</sup> These are produced by the involuntary rapid contrac-



FIG. 125.—*Progressive muscular atrophy.* Age of patient, forty-five years. (From Friedrich.)

tions of fasciculi of fibers in a muscle. Sometimes a patient is covered with them. Some years ago, these fibrillary contractions were held to be pathognomonic, but I can assure you that this is not so, as they may be observed in lead palsy,

<sup>1</sup> These peculiar twitchings give the appearance of something alive being underneath the skin. Hammond states that "they can always be excited by a smart tap of the finger upon the atrophied muscle."

in conditions of neurasthenia, and in simple paralysis. Indeed, many years ago Professor Schiff, now of Geneva, showed that muscles separated from their motor nerves were prone to show fibrillary contractions.

The *ball of the thumb* is often the starting-point of this disease. For some reason, the muscles of the foot are not affected in the same proportion in those cases where the lower extremity is involved as the hand is in cases affecting the upper extremity. In some instances, every muscle in a region but one may be atrophied, and that one seem to remain perfectly normal. If you use a surface thermometer, you will generally detect a *fall of temperature* over the affected muscles.<sup>1</sup> When the respiratory muscles become involved, death may be produced from imperfect performance of that function. The disease seems to affect males rather than females, and to be most frequent during middle life. It is sometimes associated with a congenital predisposition.<sup>2</sup>

The *muscles of the thigh* are frequently affected with atrophy, following degeneration of the ganglion cells of the anterior horns of the spinal gray matter. This causes not only a very marked deformity (since the calf may even exceed the thigh in its circumference), but a peculiarity of gait is thus produced which differs from those described in connection with locomotor ataxia, tetanoid paraplegia, and paresis.

If the extensor muscles, which are situated upon its anterior portion, are atrophied, the foot can not be carried forward in the normal manner, if at all; while the leg and foot can not be raised, if the flexor muscles of the knee joint be impaired by an atrophy confined to the posterior aspect of the thigh, thus compelling the psoas and iliacus muscles to lift the weight of the entire upper extremity by using the pelvis as a fixed point.

<sup>1</sup> Hammond reports this fall in temperature as often reaching five degrees below the normal standard.

<sup>2</sup> See the careful investigations made by Hammond, and reported by him in his excellent work, "A Treatise on the Diseases of the Nervous System." New York: D. Appleton & Co., 1876.

*Distortions* of the affected members often accompany the condition of progressive muscular atrophy. These are to be accounted for by the fact that a simultaneous impairment of all the muscles seldom occurs, and those antagonistic to the ones affected tend to produce an abnormality of attitude in the part upon which they both acted in health.

#### CENTRAL MYELITIS.

Among the diseases of the kinesodic system may be mentioned the condition known as "central myelitis." In this affection, the gray matter of the cord is the seat of a chronic type of inflammation in its central portion; hence, it may involve either the kinesodic or the æsthesodic system. The inflammatory process may extend to the anterior horns, or may create compression of the cord, in almost any portion, by the exudation which results. The symptoms of this disease must, therefore, of necessity, vary with the seat of the pathological changes, and, in some cases, be very obscure and apparently confusing to the diagnostician. We may have the manifestations confined, for a time, to the sensory nerves, possibly accompanied by pain, numbness, anæsthesia, formication, etc. Gradually certain manifestations will appear in the motor nerves, and paralysis of certain muscles and possible atrophy may be developed. The reflex action may be increased in some parts and diminished in others, according to the portion of the gray matter involved; bed-sores and paralysis of the bladder and rectum may be present in some cases, and absent in others; the legs may be anæsthetic, and at the same time paralyzed; so may the arms, without the legs, or both may be thus affected; certain parts may have the tetanoid condition described in a previous portion of this lecture; and, in fact, every known combination of sensory and motor symptoms may be present, complicated or uncomplicated by the evidences of muscular rigidity. You can thus understand that the disease is seldom recognized in its early stage, and, as it often takes years to reach a full development, an abundant opportunity will generally be afforded you for a careful and



close analysis of the symptoms which are successively brought to your notice.<sup>1</sup>

"NON-SYSTEMATIC" OR "FOCAL LESIONS" OF THE SPINAL CORD.

We have now considered, in this course of lectures upon the spinal cord, those lesions which are called "systematic," since they tend to extend upward or downward in the same column of the cord without spreading laterally; and it now remains for us to review such points as pertain to those focal or non-systematic lesions which have been enumerated in the table of diseases of the spinal cord. It is often possible and of great practical importance to the diagnostician to tell in what region of the cord the lesion is situated, and to estimate the height to which it has progressed. Of course, this is much easier in focal lesions than in the systematic, since the different columns of the cord can then simultaneously furnish symptoms which can be compared, and thus aid in the diagnosis. If you will look again at the table,<sup>2</sup> to which I some time ago directed your attention, you will perceive that the focal lesions include traumatism (of all forms); compression of the cord (chiefly by bone and tumors); transverse sclerosis of the cord; transverse softening of the cord; hæmorrhage into the substance of the cord; and, finally, certain tumors which involve the cord itself. There are many other causes which might excite some local lesion, but these are the ones which will most frequently come under the notice of the practitioner.

Before we begin the study of the symptoms produced by lesions at different heights in the spinal cord, it may be well to glance hastily at the drawing which I have made for you upon the blackboard, copied from one made by Seguin from the text of Malgaigne, which is so simple and diagram-

<sup>1</sup> The valuable contributions of Hallopeau, in the "Archives Générales de Médecine," 1872, added much to the knowledge of this obscure affection. Schüppel, Westphal, and Leyden have also been prominent as investigators of this rather rare form of disease.

<sup>2</sup> See page 315 of this volume.

matic as to illustrate certain points of great clinical value and importance.

Now, if you will look at this diagram, you will perceive that the line upon the left represents the different levels of

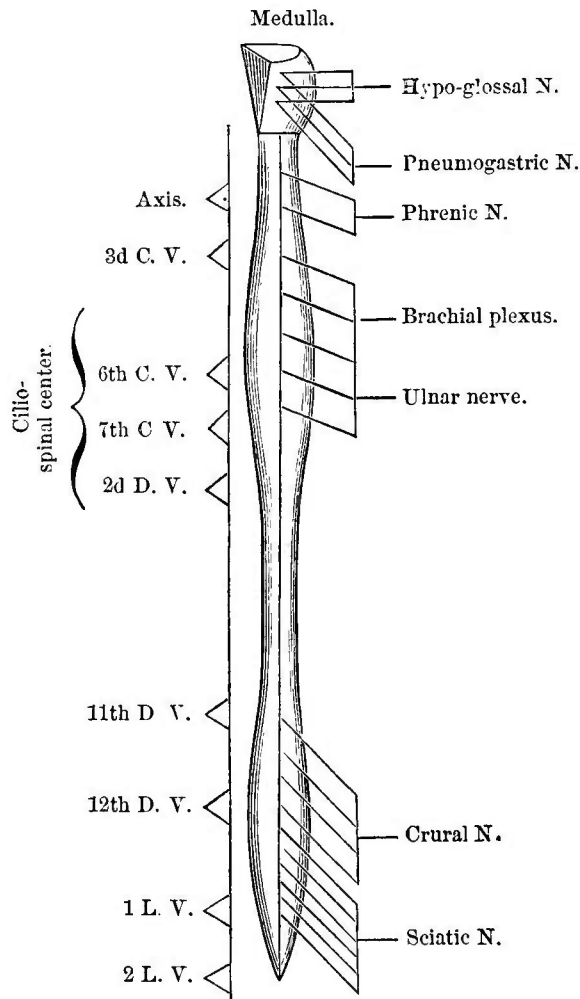

FIG. 126.—A diagram showing the relation of the spinous processes of the vertebræ to the spinal nerves and spinal cord. (Malgaigne and Seguin.)

the spines of the vertebræ, and that the special points in the cord, as well as the points of origin of certain of the more important nerves, are likewise shown. You will observe that the hypo-glossal and the pneumogastric nerves arise from the medulla, which lies above the level of the axis;<sup>1</sup> that the phrenic arises on a level with the spine of the axis; that the brachial plexus and the ulnar nerve are connected with the

<sup>1</sup> This drawing illustrates the fact that the spines of the respective vertebræ do not always correspond to the level of the nerves which escape from between their pedicles.

cord in the region of the neck (third to sixth cervical spines) ; that the cilio-spinal center is situated between the fifth cervical and the second dorsal vertebræ ; that the lumbar enlargement of the cord gives off the crural and sciatic nerves at different points, and that the space between the eleventh dorsal and the second lumbar spines includes the point of origin of both ; finally, that the spinal cord ends at the second lumbar spine, although the nerves continue to escape from the spinal canal much below that point. Such a diagram will prove of constant service to you, in following the discussion of the symptoms of focal lesions situated at different heights within the spinal cord.

We have already studied the effects of systematic lesions, both of the kinesodic and æsthesodic systems, and have noticed how perfectly the physiology of the spinal cord is confirmed by lesions affecting the anterior or posterior portions of the cord separately. We are now to investigate those lesions which, by extending in a transverse direction, are liable to be accompanied by symptoms referable to both the sensory and motor portions of the cord. Of course, the symptoms will be modified by the extent of the lesion in a transverse direction, so that they may be mostly sensory or motor ; but the presence of both sensory and motor symptoms is *strongly diagnostic of focal lesions*, irrespective of a predominance of either, and is never produced by any systematic lesion of the cord, with the one exception of central myelitis.

We will start with a general statement, as a guide in our study of focal lesions, which is as follows : focal lesions usually give rise to *paralysis of motion*, to an *alteration* in the *reflex excitability* of the cord (usually an increase), and to more or less *anæsthesia*, *numbness*, and *pain* ; the *bladder* and *rectum* are *often paralyzed*, and a *tendency to bed-sores* is frequently produced. The first two of these effects, and also the last, are due to alteration in the kinesodic system ; the remaining ones are the result of some disturbance to the æsthesodic system.

In studying focal lesions situated in different regions of the spinal cord, we must adopt some system, if we expect to grasp the fine distinctions which can be drawn between the results of lesions of the upper cervical region, the cervical enlargement, the mid-dorsal region, the region just above the lumbar enlargement, and, finally, the lumbar enlargement itself. Most of these distinctions depend upon certain *anatomical points*, which your previous drill will enable you to appreciate more easily than if your anatomical knowledge had become deficient from a lack of review.

#### FOCAL LESION IN THE UPPER CERVICAL REGION.

In this condition, hemiplegia will be produced if one lateral half of the cord be alone affected, while paraplegia will be present if the lesion extends transversely to both lateral halves of the cord. The hemiplegia or paraplegia will be complete below the head, and the entire body may be rendered anæsthetic. Since the *phrenic nerve* arises at this point, the act of respiration will be interfered with, creating dyspnoea and hic-cough; but the respiration will not be arrested, since the pneumogastric nerves continue to excite it, and the auxiliary muscles of respiration can expand the chest without the action of the diaphragm. Should the lesion be a surgical one (as it usually is), the *respiratory center* of the medulla may be affected, and death take place from asphyxia; but I do not think such a result can be explained as a simple effect of paralysis of the phrenic nerves alone. The presence of the *cilio-spinal center* in the lower cervical region may cause the pupils to show an irregularity, and the face and neck may manifest a marked increase of temperature.<sup>1</sup> The pulse may be rendered variable, from irritation of or pressure upon the *acceleratory center* of the heart.

Now, as I have before said, this type of lesion is almost always a surgical one, comprising pressure from fracture, dislocation, caries, tumors of the vertebræ, etc., and these cases

<sup>1</sup> See page 134 of this volume for effects of blood-vessels upon the iris; and also page 135 for the evidences of diminished iritic reflex.

seldom live long enough for us to study the effects of such a lesion with much detail. In those rare instances where the lesion is non-traumatic and slowly developed, the effects of irritation have been shown in a hiccough (probably due to irritation of the phrenic nerve), acceleration of the pulse (from irritation of the acceleratory center of the heart), and dyspnoea (from some interference with the phrenic nerve or the nucleus of the pneumogastric nerve in the medulla); while the paralysis has first appeared as a paretic condition of the arms, then of the chest, and, finally, of the lower limbs.

#### FOCAL LESIONS OF THE CERVICAL ENLARGEMENT.

This type of lesion differs in its effects, if developed suddenly or gradually, and also when situated in the upper or the lower part of the enlargement. If the lesion be so situated as to create *only irritation* of the cilio-spinal center, or the acceleratory center for the heart (both of which are in that vicinity), the effects will differ from those due to actual pressure upon or destruction of those centers.<sup>1</sup> In the first instance, the pupils will usually be dilated and the face pale, while the heart will be accelerated; in the latter, the pupils will generally be contracted, the face and neck flushed, and the pulse retarded. The effects will also differ if the lesion affects both lateral halves of the cord or only one.

Wherever the lesion be situated within the cervical enlargement, the arms and legs will gradually become paralyzed; the arms and hands usually becoming first numb and paretic, and the lower limbs exhibiting, for some time, only a sense of weakness and evidences of an increased reflex excitability. A sense of constriction around the chest (the so-called "cincture feeling") is generally present, the seat of which varies with that of the exciting lesion.

When the lesion is situated at the *upper part* of the enlargement, the motor and sensory symptoms will be manifested in the lower extremities, the trunk, and in nearly all the

<sup>1</sup> The reader is referred to the pages on the third cranial and pneumogastric nerves for details as to the effects upon the eye or heart.

regions of the upper extremities. The constricting band around the thorax is referred to the *level of the clavicles*, and dyspnoea is often excessive. If you will look at the diagrammatic cut,<sup>1</sup> you will perceive that the brachial plexus is marked as associated with the upper part of the cervical enlargement, and the ulnar nerve with the lower part; hence the paralysis of the arms in this case would naturally be manifested in almost all of the regions of the upper extremity, and also in those parts supplied by the brachial plexus above the clavicle.

If the lesion be situated in the *lower part* of the cervical enlargement, the symptoms exhibited will include a loss of faradic reaction of those muscles which are supplied by the *ulnar nerve* (rather than those of the arm and the extensors of the forearm), and atrophy of these muscles will often be developed, chiefly in the flexors of the wrist and the small muscles of the hand.<sup>2</sup> The same sense of constriction (cincture feeling), as experienced in most spinal lesions of a local character, will exist, but it will be referred to the upper part of the chest. A paralytic condition of the muscles of the trunk (the intercostals, triangularis sterni, and the accessory muscles of respiration), as well as of the abdominal muscles, will be detected in severe cases, rendering both inspiration and expiration embarrassed, and thus adding to the danger to life. The lower limbs may exhibit evidences of numbness, anæsthesia, paresis, or complete paralysis, depending upon the extent of the lesion and the destruction done to the tissues of the cord. A condition of paralysis may also exist in the upper extremity.

In surgical injuries to the upper portion of the cord, a peculiarity is often noticed in the *temperature of the body*, which is sometimes greatly elevated. This clinical feature may be associated with a marked retardation of the action of the heart (apparently confirming the situation of an *acceleratory center* for that organ in the spinal cord).

<sup>1</sup> See page 340 of this volume.

<sup>2</sup> The reader is referred to subsequent pages for the symptoms of ulnar paralysis.

## FOCAL LESIONS OF THE MID-DORSAL REGION OF THE SPINAL CORD.

In the early stages of this condition the lower limbs become paretic, and a condition of increased reflex excitability is manifested by a rigidity and stiffness of the impaired muscles whenever the patient attempts to stand or walk. As the disease progresses, the muscles become paralyzed and contracted<sup>1</sup> (probably on account of changes of a secondary character in the lateral columns of the cord). In some cases, the reflex movements assume the type of spasms, so as to exhibit both tonic and clonic contractions. It was this symptom which suggested to Brown-Séquard the name of "spinal epilepsy," since it occurs when the patient is exposed to the slightest peripheral irritation, and often when in the recumbent posture.<sup>2</sup> The sense of constriction around the body is referred to the region of the navel, or that of the lower ribs, or possibly as high as the axilla, since it may be taken as a relative guide to the highest limit of the lesion. A peculiarity exists in this condition as regards the bladder and the rectum; although they may be paralyzed, they are often enabled by the aid of reflex action to expel their contents, thus apparently having regained their function. In the early stages, the urine and fæces may be too hastily expelled for the comfort of the patient, often compelling the performance of either act before a proper place can be reached; but, in the advanced stages, the urine is retained to such an extent as to cause an "overflow," which is often mistaken for an actual incontinence,<sup>3</sup> since a constant dribbling is present. This symptom is always an indication for the regular use of a catheter. The sexual function seems to be often unimpaired, as coition is frequently possible. It is seldom that the paralyzed muscles exhibit a tendency to atrophy, and the electrical reaction of

<sup>1</sup> A term used in contradistinction to the word "contracted," to designate a *permanent* shortening rather than a temporary response to a motor impulse.

<sup>2</sup> The presence of urine in the bladder or of fæces in the rectum may often create these spasms.

<sup>3</sup> For the diagnosis between these two conditions, the reader is referred to "A Practical Treatise on Surgical Diagnosis," by the author. William Wood & Co., New York, 1880.

the affected parts is either normal or exaggerated. The chief seat of weakness is usually detected first in the feet, and the paralysis gradually involves the entire lower limbs.

FOCAL LESIONS ABOVE THE LUMBAR ENLARGEMENT OF THE SPINAL CORD.

In this situation, a focal lesion of the cord produces about the same sensory and motor symptoms as those described in connection with a lesion of the mid-dorsal region, with the exception that the *reflex spasms*, present in the paralyzed muscles, are perhaps somewhat less violent than when the lesion is higher up the cord. These tonic and clonic spasms are, however, sufficiently well marked to constitute a prominent symptom,<sup>1</sup> and they indicate an increased reflex excitability of the gray matter of the cord below the seat of the lesion. An ingenious explanation of this increased reflex has been advanced by Professor Seguin of this city, which seems to merit respectful consideration. I quote from a late paper<sup>2</sup> of his upon affections of the spinal cord, as follows :

“The classic theory of the physiology of contracture in hemiplegia is that it is due to the secondary degeneration—*i. e.*, actively caused by the lesion of the postero-lateral column. Seven years ago (see “Archives of Scientific and Practical Medicine,” vol. i, p. 106, 1873) I rejected this hypothesis, and suggested a different one, which I have since elaborated and taught in my clinical lectures at the College of Physicians and Surgeons, New York. This hypothesis, which I intend shortly to publish in detail, is briefly that the spasm is due, not to direct irritation from the sclerosed (?) tissue in the postero-lateral column, but to the cutting off of the cerebral influence by the primary lesion, and the consequent preponderance of the proper or automatic spinal action—an action which is mainly reflex. This theory explains the phenomena observed in cases of primary spinal diseases with descending degeneration, and can be reconciled with results of experi-

<sup>1</sup> These reflex spasms have been called by Brown-Séguard “spinal epilepsy.”

<sup>2</sup> “Annals of Anatomical and Surgical Society,” Brooklyn, December, 1880.



ments on animals (increased reflex power of spinal cord after a section high up, Brown-Séguard ; inhibitory power of the encephalon on the spinal cord, Setchenow).”

The urinary and rectal organs are affected in about the same way as in lesions of the dorsal region. Coition is often possible, and erections are normally frequent. The rectum is paralyzed, as a rule, and constipation is usually present on that account. Micturition becomes slow and interrupted, as the bladder grows parietic, and retention and overflow are produced later on in the disease.

The paralysis of the extremities is first noticed in the feet, which have long before exhibited a sense of weakness and easy fatigue. Numbness and anæsthesia usually accompany the motor paralysis, and extend as high as the groin or the waist. The sense of a constricting band around the body is present here, as in lesions of other localities, and is referred to the waist, below the level of the umbilicus, or at the level of the hips.

#### FOCAL LESIONS OF THE LUMBAR ENLARGEMENT.

If you will look at the diagram of the spinal cord upon the blackboard,<sup>1</sup> you will perceive that the lower portion of the lumbar enlargement is represented as giving origin to the *sciatic nerve* ; hence, it is reasonable to expect that a lesion situated in the lower part of this enlargement would be manifested by symptoms of an incomplete paraplegia, in which the muscles supplied by the sciatic nerves would be the most affected.<sup>2</sup> Now, this fact seems to be confirmed by clinical experience, since the feet, legs, posterior aspect of the thighs, and the region of the nates are chiefly paralyzed when the lesion is so situated. The bladder is unaffected, but the sphincter ani muscle is often rendered parietic, or it may be entirely paralyzed. The portions of the limbs which are to become the seat of paralysis usually exhibit a *sense of numbness* before the effects of the lesion are fully developed, and, in case the

<sup>1</sup> The reader is referred to the figure on page 340 of this volume.

<sup>2</sup> The reader is referred to the pages which treat of the clinical points pertaining to the sciatic nerve, for the symptoms of this type of paralysis.

posterior columns of the cord be involved, complete anæsthesia may also exist in the parts supplied with motor power by the sciatic nerve. The condition of the paralyzed muscles, as to their electrical reactions, and the presence or absence of the evidences of increased reflex excitability will depend greatly upon how much damage has been done to the gray matter of the lumbar enlargement. If the gray matter be so destroyed as to impair its function, the reflex movements will be absent; and, if the trophic function of the cord be affected by changes in the ganglion cells of the gray matter, the paralyzed muscles will undergo atrophy. The sense of constriction, or "band feeling," will usually be referred, in this lesion, either to the ankle, leg, or thigh.

FOCAL LESIONS CONFINED TO THE LATERAL HALF OF THE SPINAL CORD.

In discussing the focal lesions of the cord, we have described the clinical points which are afforded by destruction, to a greater or less extent, of the substance of the cord in both of its lateral halves; hence, the motor and sensory symptoms have been usually referred to both sides of the body. It was necessary to thus describe them, since focal lesions, unless traumatic, are seldom confined to one lateral half of the cord; but, in some cases which may be presented to your notice, where a tumor, a fractured vertebra, a hæmorrhage, a severe contusion, or some other localized lesion exists, the injury done to the spinal cord may be confined exclusively to one lateral half, resulting in one of two named conditions, viz., "spinal hemiplegia" and "hemi-paraplegia." Before proceeding to the special consideration of either of these conditions, it may prove of advantage to review some few points in the physiology of the cord, and to again direct your attention to the two plates upon the blackboard, which are already familiar to you.

This plate<sup>1</sup> shows you that any lesion of a *lateral half* of the spinal cord must produce anæsthesia in the *opposite side of the body*, since all the sensory nerves *decussate* and enter

<sup>1</sup> See Fig. 120 of this volume.

the gray matter of the cord, which serves as a conducting medium for sensory impressions, while the *motor symptoms* produced by the same lesion must be confined to the *same side of the body as the lesion*, since no decussation probably occurs in the spinal cord (these fibers decussating only in the medulla oblongata).

This second diagram<sup>1</sup> will further assist you to appreciate the fact that lateral lesions, as well as those which affect the entire cord, are modified, as regards their symptomatology, by the *height of the lesion* in the cord; since the motor nerves, and the special centers which are situated in the cord itself, will only be affected when they lie below the seat of the lesion or are directly involved in the destructive process. It will, therefore, be unnecessary to enter again into detail as to the full bearings of the plate, since they are probably fresh in your memory.

When the focal lesion is placed high up in the substance of the spinal cord, the motor paralysis affects *one side only* of the body (provided the lesion is confined to a lateral half), and the term “spinal hemiplegia” is applied to this form of paralysis in contradistinction to a hemiplegia of cerebral origin. If the spinal lesion be situated in the dorsal region and be confined to the lateral half of the cord, a motor paralysis of *one half* of the same side of the body *below the seat of the lesion* is developed, a condition to which the term “hemi-paraplegia” is commonly applied. In closing the clinical aspects of lesions of the spinal cord, it will be necessary, therefore, for us to consider the essential features of these two remaining conditions.

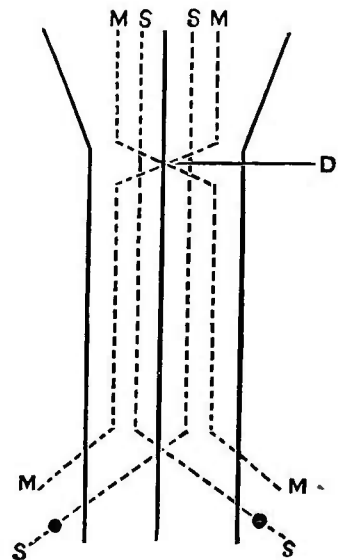

FIG. 127.—A diagram to show the course of the motor and sensory paths in the spinal cord. (Brown-Séguard.)

D, decussation of pyramids; M, motor paths; S, sensory paths.

<sup>1</sup> The reader is referred to page 307 of this volume for details as to the utility of this figure in the study of spinal affections.

## SPINAL HEMIPLEGIA.

In order to produce a typical case of this condition, it is necessary to have a lateral focal lesion of the cord in its uppermost part (in or above the cervical enlargement of the cord). If we suppose, then, that such a lesion be present, let us see what we might reasonably expect, on purely physiological grounds, would be the result. We can then examine the clinical rec-

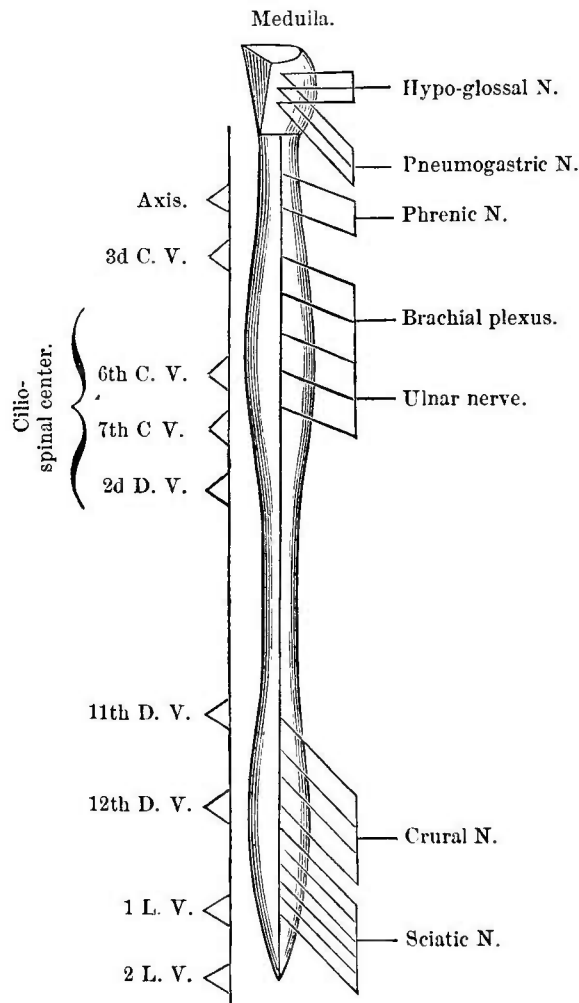

FIG. 128.—A diagram to show the relation of the spinous processes of the vertebrae to spinal nerves. (Malgaigne<sup>1</sup> and Seguin.)

ords of such cases, and either confirm our deductions or gain some additional information. Such a lesion would, in the first place, shut off all motor impulses sent out from the brain to parts below the lesion, on the same side as the lesion, since

<sup>1</sup> "Traité d'Anatomic Chirurgicale."

the decussation of the motor fibers has already taken place in the medulla ; hence motor paralysis should, theoretically, occur in the arm and leg of the side of the body corresponding to the seat of the exciting lesion, and the trunk should also be paralyzed upon that side. This we find, clinically, to be true,<sup>1</sup> with the exception that the *intercostal nerves* often retain their motor power when the nerves of the arm and leg are no longer capable of carrying motor impulses. In the second place, we should expect to find that the *sensation* of the side of the body opposite to the seat of the lesion would be destroyed or greatly impaired, since the sensory nerves decussate throughout the entire length of the cord. This we also find confirmed by clinical facts ; and so perfect is this anæsthesia that the line can often be traced to the mesial line of the body exactly, and upward to the limit of the exciting lesion. In the third place, the situation of the *cilio-spinal center* in the cervical region of the cord would naturally suggest some effects upon the pupil,<sup>2</sup> and the circulation and temperature of the face, neck, and ear of the same side. This is also confirmed, as the pupil does not respond to light, but it still acts in the accommodation of vision for near objects, and the skin of the regions named becomes red and raised in temperature. Finally, the presence of *vaso-motor centers* in the cord might occasion a rise in temperature in the paralyzed muscles ; and, strangely confirmatory of this fact, we often find the temperature of the paralyzed side of the body hotter than that of the anæsthetic side.

In some exceptional cases, the face, arm, and trunk are alone paralyzed, the legs seeming to escape, and often giving evidence of reflex spasm (perhaps most commonly on the anæsthetic side). This must be explained as the result of incomplete destruction of the lateral half of the cord.

<sup>1</sup> The researches of Brown-Séquard, as early as 1849, and his published memoirs (1863-'5 and 1868, 1869), have probably done more to clear up this field and to place it upon a positive foundation than those of any other observer.

<sup>2</sup> The reader is referred to pages 114 and 135 of this volume.

## HEMI-PARAPLEGIA.

This condition is the result of some focal lesion of the spinal cord in the *dorsal region*, which involves only its lateral half. The results of such a lesion differ but little from those of one causing spinal hemiplegia, as regards the motor and sensory symptoms, excepting that the situation of the exciting cause is below the cervical enlargement, where the nerves to the upper extremity are given off, and where the cilio-spinal center is situated. For that reason the muscles of the upper extremity are not paralyzed, nor are the effects upon the pupil and the skin of the face, ear, and neck (mentioned as present in spinal hemiplegia) produced. The muscles below the seat of the lesion are paralyzed on the side of the body corresponding to the exciting cause, and the skin is sometimes rendered hyperæsthetic upon that side;<sup>1</sup> while the integument of the side opposite to the lesion is deprived of sensibility. The bladder and rectum may be paralyzed in some instances. The sense of constriction, or "band feeling," will vary with the seat of disease in the spinal cord. The amount of *reflex irritability* and the presence or absence of *muscular atrophy* in the parts paralyzed will depend upon the depth of the lesion in the spinal cord and the changes which have been produced in the gray matter. The same increase of temperature in the paralyzed limb, which was mentioned as occurring in spinal hemiplegia, may also be present in this variety of paralysis.

Should the side affected with anæsthesia give any evidence of motor paralysis or muscular weakness, or symptoms of anæsthesia appear upon the side where the motor paralysis is present, you may regard either one as conclusive evidence that the exciting lesion is progressing, and that the opposite lateral half of the cord is being involved to a greater or less extent.

<sup>1</sup> This is probably due to some irritation of the gray matter of the cord.

# THE SPINAL NERVES.

*THEIR ORIGIN, DISTRIBUTION, FUNCTIONS, AND  
CLINICAL IMPORTANCE.*





## THE SPINAL NERVES.

---

WE have now considered the general points in the construction of the cerebro-spinal axis, and the clinical facts which pertain to the brain and spinal cord. We have also separately discussed those nerves which are connected with the brain, and have noted all the peculiarities in their distribution and anastomoses, which seem to shed a light upon their physiological action or the clinical features which each of them presents. It now remains for us to investigate those nerves of the neck, trunk, and the extremities which are connected with the spinal cord, and are called "spinal nerves," in contradistinction from the nerves of cranial origin, or those of the sympathetic.

The spinal nerves comprise thirty-one pairs, which escape from each side of the spinal cord by two roots, called the anterior or "motor root," and the posterior or "sensory root." These two roots join with each other, in every instance, to form one nerve, which is named in accordance with its situation and the region of the vertebral column from which it escapes; since the nerves, so formed, pass through foramina between the pedicles of the vertebræ, throughout the entire length of the spinal column. Thus we have *eight pairs of cervical nerves*, escaping upon either side of the cervical vertebræ; *twelve pairs of dorsal nerves*, bearing the same relation to the dorsal region of the spine; *five pairs of lumbar nerves* on each side; *five pairs of sacral nerves*,

escaping from the foramina of that bone; and *one pair of coccygeal nerves*.

As mentioned in the lectures upon the construction of the spinal cord, the anterior roots of the spinal nerves are connected with the gray matter of the anterior horns; while the posterior roots are connected with the posterior horns of the

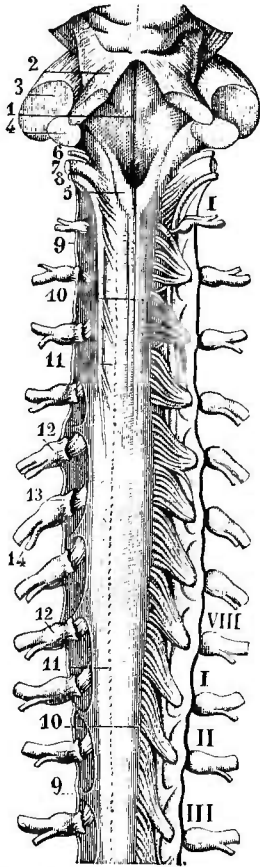

FIG. 129.—Cervical portion of the spinal cord. (Hirschfeld.)

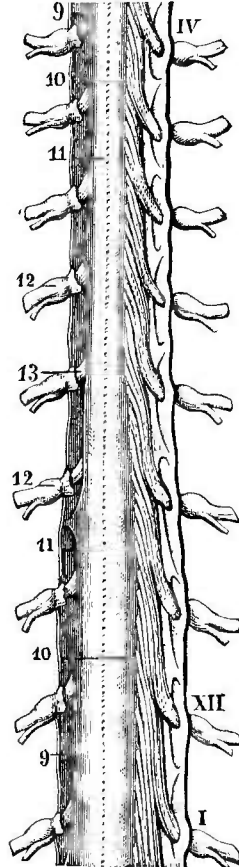

FIG. 130.—Dorsal portion of the spinal cord. (Hirschfeld.)

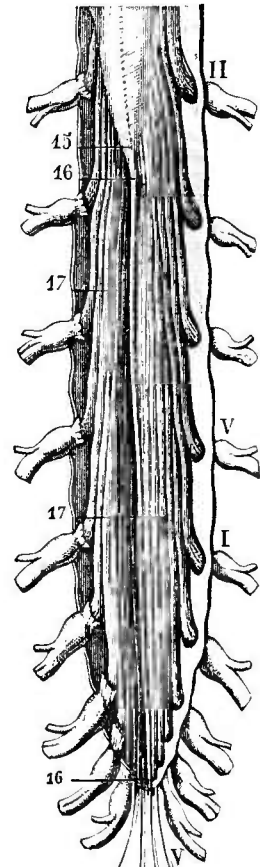

FIG. 131.—Inferior portion of the spinal cord, and cauda equina. (Hirschfeld.)

- 1, antero-inferior wall of the fourth ventricle; 2, superior peduncle of the cerebellum; 3, middle peduncle of the cerebellum; 4, inferior peduncle of the cerebellum; 5, inferior portion of the posterior median columns of the cord; 6, glosso-pharyngeal nerve; 7, pneumogastric; 8, spinal accessory nerve; 9, 9, 9, 9, dentated ligament; 10, 10, 10, 10, posterior roots of the spinal nerves; 11, 11, 11, 11, posterior lateral groove; 12, 12, 12, 12, ganglia of the posterior roots of the nerves; 13, 13, anterior roots of the nerves; 14, division of the nerves into two branches; 15, lower extremity of the cord; 16, 16, coccygeal ligament; 17, 17, cauda equina; I—VIII, cervical nerves; I, II, III, IV—XII, dorsal nerves; I, II—V, lumbar nerves; I—V, sacral nerves.

gray matter. Like all sensory neves, the posterior roots have a *ganglionic enlargement*<sup>1</sup> developed upon them, while the

<sup>1</sup> The presence of a ganglion upon a cerebro-spinal nerve is always an evidence of its sensory character.

anterior roots, being motor in function, do not. The roots of the first cervical nerves are small, short, directed horizontally, and the anterior is the larger of the two; those of the remaining cervical nerves become larger, longer, and more oblique as you descend the cord, and the posterior root is considerably larger than the anterior. In the dorsal region, the first dorsal nerve resembles the lower cervical nerves as to the actual and relative size of its roots, but the roots of the remaining dorsal nerves are smaller than those of the cervical region, and more nearly equal in their relative size. The roots of the lumbar and upper sacral nerves again increase in size from above downward. Finally, the lower sacral and the coccygeal nerves show a gradual decrease in the size of their roots, the last sacral and the coccygeal nerves having the smallest roots of any of the spinal nerves. As regards the relative size of the anterior and posterior roots, the lumbar, sacral, and coccygeal nerves exhibit but little difference.

The *length* and *inclination* of the roots of the spinal nerves increase from the first to the last; hence the *place of escape* of a spinal nerve does not indicate its *seat of origin*. As the spinal cord does not descend beyond the first lumbar vertebra, the length of the roots of the lumbar, sacral, and coccygeal nerves increases, from nerve to nerve, by the thickness of one vertebra.

The trunk of each spinal nerve, after its escape from the vertebral canal, immediately divides into an anterior and a posterior primary division.

In treating of the spinal nerves, I will first direct your attention to the four upper cervical nerves, since they enter into the formation of the cervical plexus; then to the remaining cervical and the first dorsal nerves, since they enter into the formation of the brachial plexus; and, later on, the dorsal, lumbar, sacral, and coccygeal nerves will be separately considered. By this method of subdivision, which is the one usually followed by all authors upon anatomy, the nerves can be more satisfactorily traced from their origin to their terminal distribution than if each nerve were treated of separately,

since some enter into the formation of plexuses, and thus lose their individuality.

The axioms regarding the distribution of nerves to the muscles, joints, and skin, which I quoted in the first lecture of this winter's course, will be so constantly of use in the study of the spinal nerves that they will again bear repetition. The substance of my remarks in that lecture was about as follows :

It is claimed by John Hilton<sup>1</sup> that, if we trace the distribution of the nerve filaments from any special nerve trunk to the muscles, we shall find that only those muscles are supplied by each of the individual nerves which are required to render complete the performance of the *functions* for which that nerve was designed ; and that, if muscles were classified on a basis of their nerve supply, instead of in groups of mere relationship as to locality, a self-evident physiological relation would be shown which would tend greatly to simplify a knowledge of the muscular system in its practical bearings, and to prove a design on the part of the Creator.

Thus, he says, we frequently find muscles close together and still supplied by separate nerves, one of which has possibly to go a long way out of a direct course to reach it, which is contrary to the usual method of Nature, who always uses the simplest means to accomplish her designs ; but, if we examine the *action* of these two muscles, we will find that each one acts in unison with the other muscles supplied by the same nerve, and that, to produce this perfect accord, Nature takes what, to a hasty glance, would seem to be a needless step.

He also lays down certain axioms, pertaining to the distribution of nerves and the diagnostic value of pain, which have been often repeated in these lectures, and can not but be most profitable to those who use them as a guide. They are as follows :

“*Superficial pains on both sides of the body, which are symmetrical, imply an origin or cause, the seat of which is*

<sup>1</sup> “Rest and Pain,” London, 1876 (New York, 1879).

*central or bilateral ; while unilateral pain implies a seat of origin, which is one-sided, and, as a rule, exists on the same side of the body as the pain."*

The bearings of this first axiom will be rendered very apparent when the regions of the neck and trunk are considered, since the symptom of local pain is of the greatest value in connection with diseases affecting the bones of the spinal column and the spinal cord which they invest ; but that the same rule may be applied to any of the cranial nerves, with a degree of certainty which seldom admits of error, has been shown in cases quoted in connection with the motor oculi, trigeminus, facial, and other nerves.

The second axiom is as follows :

*"The same trunks of nerves, whose branches supply the groups of muscles moving a joint, furnish also a distribution of nerves to the skin over the insertions of the same muscles ; and the interior of the joint moved by these muscles receives a nerve supply from the same source."*

By this axiom, a physiological harmony is shown between these various coöperating structures. Thus, any joint, when inflamed, may, by a reflex act through motor branches from the same trunk by which it is itself supplied, control the muscles which move it, and thus insure the rest and quiet necessary to its own repair.

Spots of local tenderness in the *cutaneous* surface may, for this reason, likewise be often considered as a guide to a source of irritation of some of the structures supplied by the same nerve, viz., the muscles underneath it, or the joints which are moved by them ; and, thus, even remote affections can be accurately determined, which, were this axiom not used as a guide, might escape recognition till an advanced stage of the disease had been reached.

It is well, however, to quote one other axiom, laid down by the same author, before leaving the subject of the diagnostic value of the cutaneous nerves as indicators of existing disease of other organs, viz. :

*"Every fascia of the body has a muscle or muscles at-*

*tached to it ; and every fascia must be considered as one of the points of insertion of the muscles connected to it," in following the previous axiom as to the cutaneous distribution of nerves.*

This guide is especially important in case the rule be applied to the extremities (arms and legs) where these *fasciæ* extend over large surfaces, more or less remote from, and apparently unconnected with, the muscles attached to them ; but it is mentioned in this connection for the especial object of calling the attention of the reader to those general rules which govern the distribution of the nerves in their entirety, before proceeding to apply them in all their individual bearings :

Without this nervous association between the muscular structures and those composing the joints, there could be no intimation given by the internal parts of their exhaustion or fatigue. Again, through the medium of this same association between the skin and the muscles, great security is given to the joints, by the muscles being made aware of the point of contact of any extraneous force or violence. Their involuntary contraction instinctively makes the tissues surrounding the joints tense and rigid, and this brings about an improved defense for the subjacent joint structures.

From the conclusion of his great work, in which Hilton endeavors to prove that mechanical rest may be used as a cure for most of the surgical disorders, the following sentences are quoted, since they can not be too often repeated :

“I have endeavored to impress upon you the fact *that every pain has its distinct and pregnant signification if we will but carefully search for it.*

“In the pain which follows the intrusion of a particle of dust on to the conjunctiva, and the closure of the eyelid for the security of rest, up to the most formidable diseases which we have to treat—pain the monitor, and rest the cure—are starting points for contemplation, which should ever be present to the mind of the surgeon.”

Now, if you will thoroughly grasp these axioms, not only as mere words, but as *grand principles*, which can be used

by you in your every-day experience as counselors of the sick, you will be better able to appreciate the tables of nerve distribution which I am constantly presenting to you upon the blackboard, so that you can record them in your note-books. These tables enable you, at a glance, to see to what muscles each separate nerve sends filaments of distribution, and thus innumerable problems are being constantly suggested to you of this character: Why does this nerve supply the muscles mentioned and omit those in the immediate vicinity? What is the common *physiological function* which these muscles are destined to perform? How may this nerve be classed from its physiological action?

It is only by such a system of self-inquiry and self-examination that you are enabled to become the master of the science. The nerves are then no longer mere cords, running without a plan, and serving only as a tax upon the memory, but electric wires, placed with a system which we, as yet, can not begin to understand in its wonderful adaptability to the demands of the body, but which a little study will show is remarkable for its simplicity of distribution, if we but seek for the function of each nerve. To a student of this character, the nerves become a source of never-ending delight, since they serve as the key to many problems in anatomy which had previously been involved in obscurity. We thus learn the *action of the muscles*, since the nerves which supply any special group enable you at once to tell that those have a similarity of function which are supplied from the same source, while those supplied from different sources are not only dissimilar in their action, but have some bond of sympathy with other muscles (possibly far distant) which are similarly supplied. I believe that the day is not far off when the *nervous supply* will constitute the universally recognized basis upon which muscles will be divided into groups; and, when that day comes, the labor of the student will be greatly lessened, and his grasp of the subject be of a higher and more comprehensive order. We will now pass to the consideration of the upper four cervical nerves, and the cervical plexus which is formed by their anterior branches.

## THE UPPER CERVICAL NERVES.

A CHART OF THE NERVES OF THE CERVICAL REGION. <sup>1</sup>

FIRST CERVICAL NERVE ( <i>Sub-occipital</i> ).	Posterior division.	<ul style="list-style-type: none"> <li>Branch to posterior division of second cervical,</li> <li>Branches to the <i>posterior cranio-vertebral set</i> of muscles,</li> <li>Branch to complexus muscles,</li> <li>Branch to <i>integument of occiput</i>.</li> <li>Branch to rectus cap. ant. major,</li> <li>Branch to rectus cap. ant. minor,</li> <li>Branch to rectus cap. lateralis.</li> </ul>
	Anterior division.	<ul style="list-style-type: none"> <li><i>Communicating branches to</i> <ul style="list-style-type: none"> <li>Second cervical,</li> <li>Pneumogastric,</li> <li>Hypo-glossal,</li> <li>Superior cervical ganglion.</li> </ul> </li> <li>Branch to occipito-atloid articulation.</li> </ul>
SECOND CERVICAL NERVE.	Posterior division (very large in size).	<ul style="list-style-type: none"> <li>External branch (supplying) <ul style="list-style-type: none"> <li>Splenius,</li> <li>Cervicalis ascendens,</li> <li>Transversalis colli,</li> <li>Trachelo-mastoid,</li> <li>Complexus.</li> </ul> </li> <li>Internal branch (<i>Great occipital nerve</i>). <ul style="list-style-type: none"> <li>Joins with first cervical nerve,</li> <li>Supplies <i>integument of occiput</i> as far as vertex,</li> <li>Gives an <i>auricular branch</i> to skin of ear.</li> </ul> </li> </ul>
	Anterior division.	<ul style="list-style-type: none"> <li>Filament to sterno-mastoid,</li> <li>Ascending branch (to first cervical nerve),</li> <li>Descending branch (to third cervical nerve),</li> <li>Filament to communicans noni nerve,</li> <li><i>Small occipital nerve</i> (occipitalis minor).</li> </ul>
THIRD CERVICAL NERVE.	Posterior division.	<ul style="list-style-type: none"> <li>External branch (supplying) <ul style="list-style-type: none"> <li>Splenius,</li> <li>Cervicalis ascendens,</li> <li>Transversalis colli,</li> <li>Trachelo-mastoid.</li> </ul> </li> <li>Internal branch (supplying) <ul style="list-style-type: none"> <li><i>Integument of occiput</i>.</li> </ul> </li> </ul>
	Anterior division.	<ul style="list-style-type: none"> <li>Ascending branches. <ul style="list-style-type: none"> <li><i>Auricularis magnus,</i></li> <li><i>Superficial cervical,</i></li> <li>Branch to second cervical nerve,</li> <li>Branch to the spinal accessory.</li> </ul> </li> <li>Descending branches. <ul style="list-style-type: none"> <li>Filament to fourth nerve,</li> <li>Filament to levator anguli scapulae,</li> <li><i>Supra-clavicular,</i></li> <li>Filament to communicans noni nerve,</li> <li>Filament to phrenic nerve.</li> </ul> </li> </ul>
FOURTH CERVICAL NERVE.	Posterior division	(distributed to muscles of the back).
	Anterior division.	<ul style="list-style-type: none"> <li>Filament to third cervical nerve,</li> <li>Filament to fifth cervical nerve,</li> <li>Filament to <i>phrenic nerve</i>,</li> <li>Filament to scalenus medius,</li> <li>Filaments to <i>supra-clavicular nerve</i>.</li> </ul>

<sup>1</sup> Modified from a table in the "Essentials of Anatomy" (Darling and Ranney). New York, Putnam's Sons, 1880.



If you will look at the table, which I have had copied for your inspection,<sup>1</sup> you will perceive that each of the upper four cervical nerves gives off an anterior and posterior branch, immediately after their escape from the vertebral canal, and that the distribution of each of these branches is shown in detail. You will perceive that every branch which supplies the in-

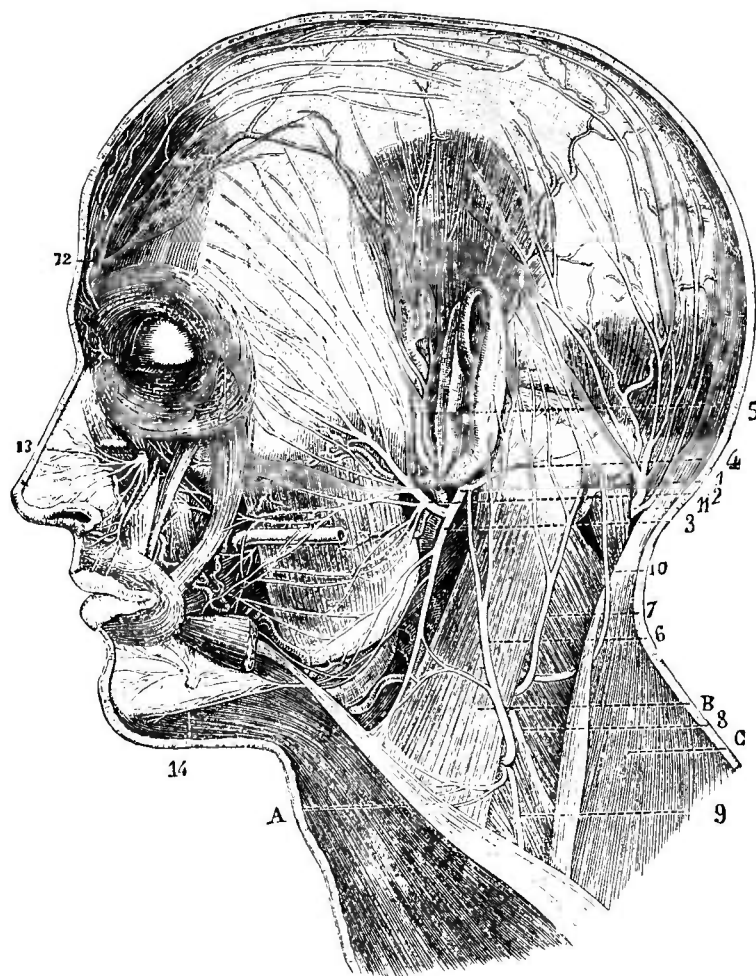

FIG. 132.—*Posterior branch of the second cervical nerve.* (Arnold.)

1, trunk of the facial; 2, its superior branch, or temporo-facial; 3, the inferior branch, or cervico-facial; 4, its posterior auricular branch; 5, auriculo-temporal; 6, auricularis magnus from the cervical plexus; 7, its mastoid branch; 8, supra-acromial branch; 9, supra-clavicular branch; 10, accessory occipitalis minor; 11, *occipitalis major*; 12, frontal division of the ophthalmic nerve; 13, infra-orbital branch of the superior maxillary; 14, mental branches of the inferior dental nerve; A, platysma myoides; B, sterno-mastoid; C, trapezius.

tegument alone is underscored,<sup>2</sup> while the muscular branches are not. Thus, the great occipital, small occipital, great auricular, superficial cervical, and supra-clavicular nerves are

<sup>1</sup> See table on the preceding page.

<sup>2</sup> *Italicized* in the table.

made particularly prominent. It will tend, however, to simplify the study of this table, if you will compare it with the one adjoining, which shows the construction of the cervical plexus.

This plexus is formed by the *anterior branches* of these four nerves, so that you will find the same nerves mentioned in both tables; since, in the first table, a nerve may be mentioned as one of the terminal filaments of a special trunk, while, in the second table, it will be enumerated as one of the branches of the plexus. I mention this point, lest some confusion may arise in your minds as to the apparent contradiction of statement, as well as for the purpose of impressing upon you the fact that a branch of any nerve plexus can usually be traced as arising from some special nerve or nerves, which assist to form that plexus. Thus we have the *phrenic nerve* arising by three heads (third, fourth, and fifth cervical), and, in part, a branch of three nerves; and again, the *communicans noni nerve*, which goes to join a branch of the hypoglossal,<sup>1</sup> arises by two heads (second and third cervical).

#### THE CERVICAL PLEXUS OF NERVES.

Anterior branch of 1st CERVICAL nerve.	Anterior branch of 2d CERVICAL nerve.	Anterior branch of 3d CERVICAL nerve.	Anterior branch of 4th CERVICAL nerve.	CERVICAL PLEXUS.	SUPERFICIAL BRANCHES (integument- ary).	Ascending set.	Occipitalis minor. . . . . Filament to attollens aurem. Auricularis magnus. Superficialis colli. . . . . Branch to platysma.	
						Descending set.	Supra-clavicular branches.	{ Sternal, Clavicular, Acromial.
						Internal set.	Communicating. <sup>2</sup>	{ Pneumogastric, Hypo-glossal, Sympathetic.
							Muscular	{ Rect. cap. ant. major, Rect. cap. ant. minor, Rect. cap. lateralis. <i>Communicans noni</i> .
DEEP BRANCHES.	PHRENIC.	External set.	Muscular.	{ Sterno-mastoid, Levator anguli scapulae, Trapezius, Scalenus med.				
		Communicating with spinal accessory nerve.						

The table which illustrates the method of construction of the cervical plexus and its branches of distribution may be

<sup>1</sup> See page 275 of this volume.

<sup>2</sup> The loop between the first and second cervical nerves usually gives off the communicating branches to pneumogastric and hypo-glossal nerves and to the superior cervical ganglion of the sympathetic, while the third and fourth cervical nerves give communicating branches to the main cord of the sympathetic nerve.

studied with some advantage. It will be seen that the plexus gives off two distinct sets of branches, called the superficial and the deep, since the former, as the name indicates, are all

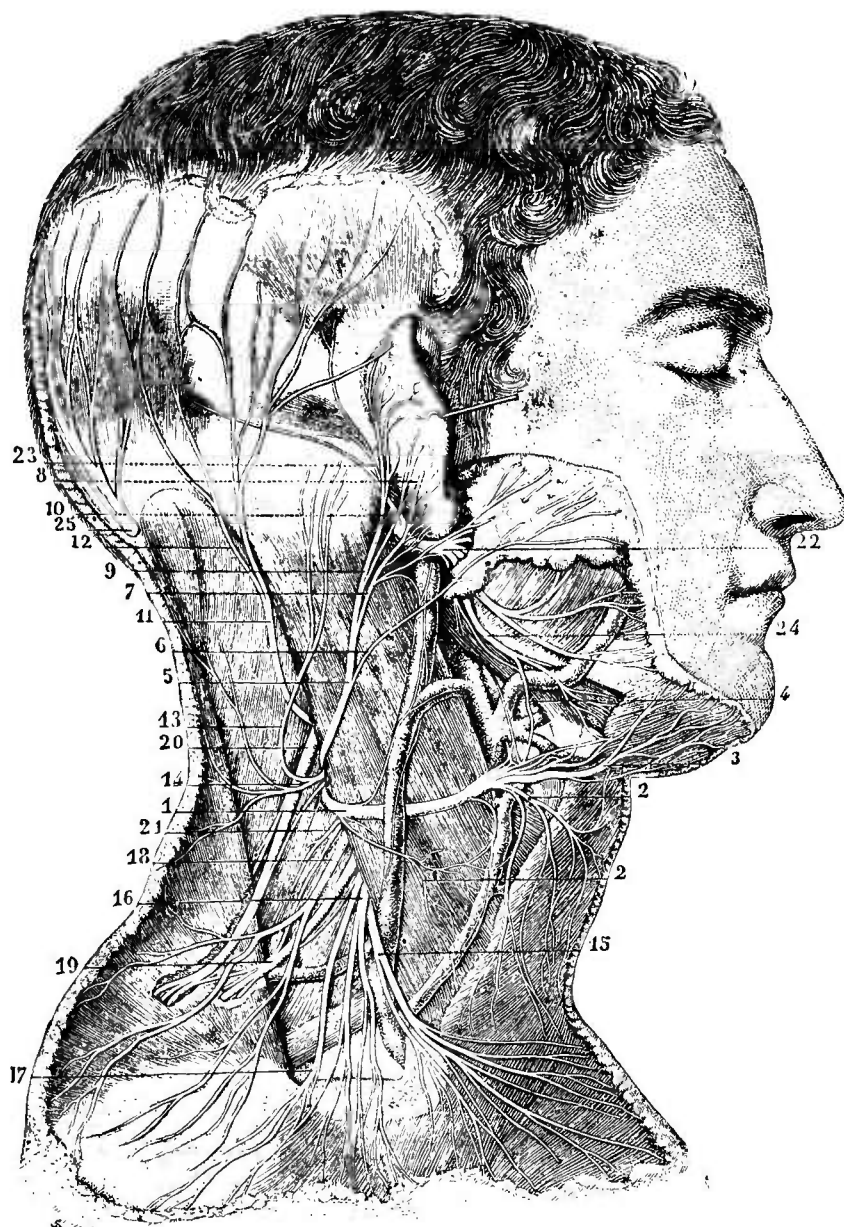

FIG. 133.—*Superficial branches of the cervical plexus.* (Hirschfeld.)

1, superficialis colli; 2, 2, its descending branches; 3, its ascending branches; 4, filaments of anastomosis with the facial; 5, auricularis magnus; 6, its parotid branch; 7, its external auricular branch; 8, upper part of the same branch, crossing the fibrous tissue which surrounds the root of the helix, and supplying the external surface of the pinna; 9, internal auricular branch; 10, filament of anastomosis between this branch and the posterior auricular of the facial; 11, occipitalis minor; 12, branch of communication with the occipitalis major; 13, accessory occipitalis minor; 14, branches to the integument on the back of the neck; 15, supra-clavicular branches, sternal portion; 16, clavicular portion; 17, supra-acromial branches, anterior division; 18, posterior division; 19, branch to trapezius from cervical plexus; 20, branch to trapezius from the spinal accessory, and anastomosing with the preceding; 21, branch to the levator anguli scapulae; 22, trunk of the facial; 23, its posterior auricular branch; 24, its cervical and mental branches.

cutaneous, while the latter are distributed to muscles and adjacent nerves. The superficial or integumentary set comprises four nerves, three of which ascend toward the head, while the remaining one descends toward the shoulder; the deep set is subdivided into branches which pass toward the mesial line of the trunk, the internal set, and those which pass away from the mesial line, the external set.

#### SUPERFICIAL BRANCHES OF THE CERVICAL PLEXUS.

The superficial set of branches is of the greatest importance to the physician, since the symptom of pain is often a most positive guide to disease, which can be localized by a thorough knowledge of the nerves. The sub-occipital nerve

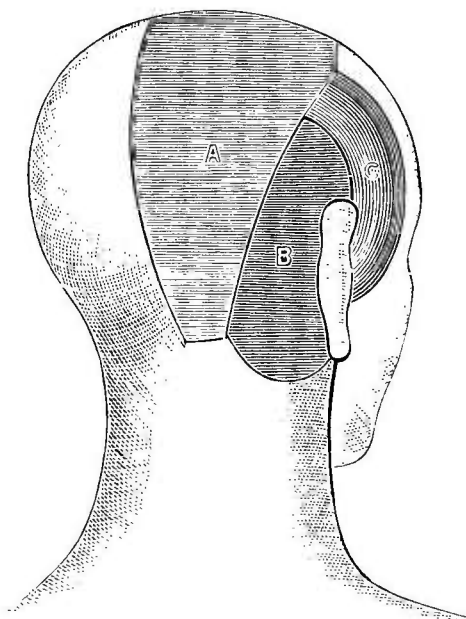

FIG. 134.— *The nerve supply of the posterior part of the head.* (Hilton.)

A, region supplied by the great occipital nerve; B, region supplied by the small occipital nerve; C, region supplied by the auriculo-temporal nerve.

(first cervical), the great and small occipital nerves (branches of the second cervical), and the auricularis magnus (a branch of the third cervical) are all distributed to the *integument of the scalp*, in the posterior region of the head, covering the space which extends from the neck to the vertex of the cranium. The plate which I now show you was designed by

Hilton,<sup>1</sup> to illustrate the results of careful experiment as to the limits of the cutaneous distribution of each of these nerves.

In my lecture upon the distribution of the fifth cranial nerve, I called your attention to the diagnostic value of the cutaneous distribution of the nerves of the ear. It may be

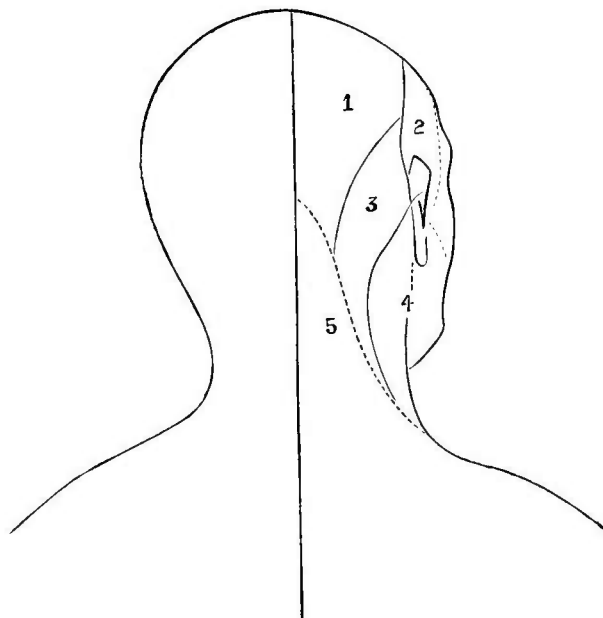

FIG. 135.—*The nerve supply of the posterior portion of head and neck.* (Modified from Flower.)

1, region supplied by the great occipital nerve; 2, region supplied by the auriculo-temporal nerve; 3, region supplied by the small occipital nerve; 4, region supplied by the great auricular nerve; 5, region supplied by the third cervical nerve.

well to again state that the integument of the pinna is supplied by the fifth cranial, the great auricular, the auricular branch of the great occipital, and the small occipital nerves,<sup>2</sup> and to impress upon you that the limits of the distribution of each are now so well defined as to afford a clew, in many instances where pain is confined to this region, to the seat of the exciting cause.

<sup>1</sup> *Op. cit.*

<sup>2</sup> The *auricular branch* which Hilton lays stress upon, as supplying the *lobule* of the ear with sensation, may be given off either by the anterior or posterior division of the second cervical nerve. In the table of the distribution of the cervical nerves I have put it down as a branch of the *great occipital* nerve, since that is its most common origin; but it, not infrequently, is found to arise from the small occipital nerve, in which case it would be derived indirectly from the anterior division of the second cervical, rather than from the posterior division.

The descending branches of the superficial set of the cervical plexus (supra-clavicular) arise from the third and fourth cervical nerves, and are distributed to the integument covering the lower portion of the neck and the regions of the sternum, clavicle, and acromion. The fact that the filaments of these nerves are distributed to the *fascia covering the upper portion of the chest*, below the clavicle, is made a point of diagnostic importance by Hilton, since cases of disease of the spinal column, in the region of escape of the third or fourth cervical nerves, or the existence of pressure along the course of these nerves, have been suggested to him by pain in this region, and thus detected far away from the seat of pain. He says: "As nothing but the nerves can produce pain, this simple distribution ought to remind us of the fact that, if a patient complains of pain in this part of the chest, the cause may lie in one of two directions. It may depend upon disease of the cervical region of the spine, or in connection with some disease affecting the origin of the upper dorsal nerves."

The cervical plexus lies upon the scalenus medius and the levator anguli scapulæ muscles, and is covered by the sternomastoid muscle; hence, all of its superficial branches emerge from beneath the posterior border of this latter muscle.<sup>1</sup> The muscles which the plexus supplies directly are the three which lie in contact with it and the trapezius. Now, it will be remembered that the trapezius and the sternomastoid muscles have another source of nervous supply, viz., the spinal accessory nerve.<sup>2</sup> This fact suggests that these muscles must each belong to two groups: the first, those which control *phonation*; <sup>3</sup> the second, those which insure the ordinary motions of the neck. In the same way, the platysma muscle, by its nervous supply, is clearly stamped as not only a muscle of the neck, but also *one of expression*,<sup>4</sup> since the facial nerve supplies it, as well as the cervical plexus.

<sup>1</sup> See figure on page 365 of this volume.

<sup>2</sup> See page 262 of this volume.

<sup>3</sup> See page 263, previous lecture, upon this nerve.

<sup>4</sup> For the action of this muscle in the expression of melancholy, see the facial nerve.

## DEEP BRANCHES OF THE CERVICAL PLEXUS.

A second reference to the table, in which the branches of this plexus are shown, will enable you to recall the subdivision of the deep branches. The set that passes toward the mesial line of the body comprises the muscular filaments to the recti muscles, the communicating branches to adjacent nerves, and two specially named trunks, the phrenic and communicans noni nerves; while the set which passes toward the periphery of the neck comprises the muscular branches to the sterno-mastoid, trapezius, levator anguli scapulæ, and the scalenus medius, and communicating filaments to adjacent nerves.

The *filaments of communication* between the cervical plexus and the pneumogastric, hypo-glossal, spinal accessory, fifth cranial, and sympathetic nerves, have been already discussed in connection with each of these nerves. They all indicate some definite purpose on the part of Nature, and can best be reviewed by a careful perusal of the notes taken by you in the early part of this course of lectures.<sup>1</sup> Many of the diagrams of the special nerves mentioned will make points clear to you which it is useless to repeat.

The *communicans noni nerve*, whose origin can be traced to two filaments connected with the second and third cervical nerves, is of surgical interest from the relation which it bears to the sheath of the carotid artery; and the branches which are given off from the loop, formed by its junction with the descendens noni nerve, can be seen by referring to the diagram of the hypo-glossal nerve.<sup>2</sup> Occasionally this nerve is found to enter the sheath of the carotid artery, and to anastomose with the descendens noni nerve in this abnormal situa-

<sup>1</sup> For the association between the fifth cranial nerve and the second cervical in the integumentary supply of the ear, see page 157; between the facial nerve and cervical nerves, see page 186; between the pneumogastric nerve and the arcade formed by the first and second cervical nerves, see diagram of pneumogastric on page 238; between the spinal accessory nerve and the upper cervical nerves and its physiological bearing, see pages 262 and 267; finally, between the hypo-glossal nerve and the communicans noni nerve, see plate on page 275 of this volume.

<sup>2</sup> See page 275 of this volume.

tion.<sup>1</sup> From the loop which it helps to form, filaments are given to the sterno-thyroid, sterno-hyoid, and both bellies of the omo-hyoid muscle. Thus these muscles are placed under the control of two nerves; the one (*communicans noni* nerve) enabling them to act in harmony with the muscles of the neck, while the other (*descendens noni* nerve) enables them to assist in depressing the larynx and the hyoid bone, after the bolus of food has passed the isthmus of the fauces, thus acting in harmony with the tongue, which is also supplied by the hypoglossal nerve. We can perceive, therefore, that these muscles are concerned in two distinct functions—the movements of the neck and the act of deglutition and speech; hence they must of necessity be separately supplied by the nerves of the neck and that of the tongue, in order to properly perform the two acts independently of each other.

The *phrenic nerve*, called also the “internal respiratory nerve of Bell,”<sup>2</sup> arises, by three heads, from the third, fourth, and fifth cervical nerves. Its course and distribution give it a surgical as well as a physiological importance. It lies in front of the scalenus anticus muscle, and thus in relation to the second portion of the subclavian artery; lower in the neck, it passes between the subclavian vein and the first portion of the subclavian artery; when it has entered the superior opening of the chest, its course upon the left side of the body lies in front of the arch of the aorta and the pulmonary artery, but upon the right side the nerve passes between the superior vena cava and the right innominate vein; each nerve crosses in front of the root of the corresponding lung, gives off twigs to the pericardium and pleura, and perforates the diaphragm, to be distributed to its under surface. Both nerves give filaments to the phrenic plexus of the sympathetic, and the right nerve furnishes some filaments to the diaphragmatic ganglion.

The distribution of the phrenic nerves to the diaphragm is mentioned by Hilton<sup>3</sup> as one of the simple devices of

<sup>1</sup> It is sometimes found beneath the jugular vein, and, occasionally, in front of it.

<sup>2</sup> This name was applied to the phrenic nerve by Bell, since it passes internally to the chest wall, and assists in the physiological act of respiration.

<sup>3</sup> *Op. cit.*



Nature to guard the nerves from injury. I quote from his excellent treatise as follows: "As a rule, nerves enter the muscles where they will be most secure from pressure, and it is curious to observe how careful Nature has been in this respect to guard one of the most important nerves in the body. The phrenic nerves (our life hangs on these threads), after passing through the chest, traverse the diaphragm and distribute their branches to the *under surface* of the diaphragm, and are so situated that they can not be compressed during respiration. If they were situated upon the upper surface of the diaphragm, where there is a constant and forced contact between the base of the lung and the superior aspect of the diaphragm, and especially so during a retained inspiration, it is obvious that the filaments of the phrenic nerve would, under such circumstances, be exposed or subjected to compression, and the action of the diaphragm would be dangerously interfered with. The nerves are, however, distributed to the under or concave surface of the diaphragm; the whole tendency of gravitation being to remove the liver, the stomach, and the spleen away from them, so as to enable the nerves to carry on their influence to the diaphragm unmolested."

How extraordinary is it that the phrenic nerve (a nerve so important to life) can pass through the chest between the dilated heart and the inflated lungs, and yet, as far as we know, never receive any untoward influence from pressure! It is true that the lungs have a remarkably definite concave form toward the heart, arching over the course of the phrenic nerve; but, when the lungs are emphysematous, it seems quite probable that these nerves might suffer from pressure, and cause some difficulty in breathing. When extravasation of air occurs from rupture of the trachea or a large bronchial tube, the patient dies rapidly from extreme shortness of breath; and this can be explained by the fact that the air enters the tract of the phrenic nerve, thus causing extreme pressure and death from paralysis of the diaphragm.

The distribution of the phrenic nerves to the *pericardium*

seems to warrant the supposition of Hilton that the pericardium may be considered as a portion of the fascial tendon of the diaphragm, since it is closely identified with it, and is acted upon by it, at all times. It may also be considered as probable that the phrenic nerves are endowed with some *sensory* filaments,<sup>1</sup> by communication with other nerves; and the analogy of the pericardium and diaphragm to a joint, so beautifully pointed out by Hilton, where the fibrous layer of the heart sac resembles the capsular ligament, the serous layer the synovial membrane, and the diaphragm the muscle which moves it, is confirmed by the similarity of nervous distribution.<sup>2</sup> We know that in pericarditis the patients complain of a sense of constriction and tightness in the chest, and are afflicted with a shortness of breath; we also see an inflamed condition of this membrane creating a spasm of the diaphragm, precisely as the nerves of an inflamed joint create a contraction of the adjacent muscles; and why are we not justified in attributing these symptoms to the analogy which anatomy so well sustains, and the axiom of nerve supply to joints seems to confirm?

#### CLINICAL POINTS PERTAINING TO THE CERVICAL NERVES.

The distribution of the branches of the upper four cervical nerves, which have been considered in some detail in the preceding lecture, may be said to furnish sensory filaments to the skin covering the occipital region as high as the vertex, and the integument of the neck, in its posterior and lateral aspects, as far down as the shoulder. The muscular filaments given off by these nerves have little clinical interest, since the diseases which are most frequently met are confined chiefly to the great occipital nerve, the cutaneous branches of the neck, and the phrenic. We will consider, therefore, only

<sup>1</sup> Luschka and Henle regard the phrenic as a mixed nerve. This view seems to be sustained by cases of neuralgia (as reported by Falot, Peter, Erb, and others) which have been produced by irritation of this nerve. The development of Luschka's ganglion upon this nerve seems to be a further evidence of the existence of sensory as well as motor fibers within the phrenic.

<sup>2</sup> See axioms of nerve distribution, on page 359 of this volume.

that type of neuralgia which affects the regions of the occiput and neck called "cervico-occipital neuralgia" and the nervous disorders dependent upon the distribution of the phrenic nerve.

*Cervico-occipital Neuralgia.*—This is a rare form of disease. It is induced by exposure, perhaps, more frequently than by any other cause. It may be also the result of diseases of the spinal column, such as periostitis, spondylitis of the cervical region, tumors, and injuries; also of wounds of the nerves, irritation of the cervical portion of the spinal cord, enlarged lymphatic glands, neuromata, tumors of the neck or spinal cord, foreign bodies, etc. Aneurism of the vertebral artery has been known to produce it.

The pain of this type of neuralgia may be continuous or paroxysmal, and either circumscribed or widely diffused over the entire occipital and cervical regions. In severe paroxysms of pain, the movements of the head and the acts of speech and mastication may be rendered difficult or impossible. Movements of the head, and the acts of laughing, sneezing, and mastication, often tend to excite the paroxysms of pain.<sup>1</sup>

As in many other forms of neuralgia, certain points of extreme tenderness, the "*puncta dolorosa* of Valleix," may be detected, and these may be distinctly located at the following spots:

1. Where the great occipital nerve escapes *at the occiput*, between the mastoid process and the first cervical vertebra.
2. Where the branches of the cervical plexus escape around the posterior border of the sterno-mastoid muscle, in the *middle point of the neck*. (This point of tenderness may be absent.)
3. Where the small occipital and great auricular nerves escape to the surface, just *behind the mastoid process*.
4. Where the frontal branch of the trigeminus, the great auricular, and the occipital nerves meet, over the situation of the *parietal protuberance*.

<sup>1</sup> The fixed attitude in which this class of patients hold their heads is very characteristic.

5. Where the auricular nerves meet, on the *concha* of the ear.<sup>1</sup>

It is the detection of these points of tenderness<sup>2</sup> that assists the diagnostician to discriminate between rheumatic pains and those of a purely neuralgic character, and it will usually be observed that the paroxysms of pain start from these points of tenderness. This type of neuralgia is often associated with a similar affection of the fifth nerve, and occasionally of the brachial plexus. It may be followed by nutritive disturbances, such as falling out of the hair over the affected region. The duration of this form of neuralgic pain varies from a few days, to weeks, months, or even years, depending somewhat upon the exciting cause.

#### DISORDERS OF THE PHRENIC NERVE.

The phrenic nerve may manifest the effects of irritation in the form of neuralgia, clonic spasm (hiccough), and tonic spasm of the diaphragm; and also that of a more serious impairment of its function, as diaphragmatic paralysis.

*Diaphragmatic neuralgia* seems to be manifested (in those few reported cases which are well authenticated) by a pain which begins in the base of the thorax, at the point of insertion of the diaphragm, and which radiates upward into the territory of the shoulder and neck, which is supplied by the cutaneous branches of the cervical plexus. The *points of tenderness* which exist in this affection seem to be most marked (1) in the region of origin of the phrenic, near to the spinous processes of the middle three cervical vertebræ; (2) over the nerve, as it enters the supra-clavicular fossa; and (3) at the anterior insertions of the diaphragm, between the seventh and the tenth ribs. It is claimed by Erb that a point of tenderness can often be detected over the cartilage of the third rib, but I find it difficult to explain this symptom on

<sup>1</sup> This point of tenderness is often absent.

<sup>2</sup> It will be noticed that these points of circumscribed tenderness correspond, in every instance, to the approach of some nerve or its terminal filaments to the surface of the body. The points of subdivision of a nerve trunk into its branches of distribution are often the seat of this excessive sensitiveness to pressure.

anatomical grounds, although its presence in some cases seems to be proven.

The pain of phrenic neuralgia is more or less continuous, since the incessant movements of the diaphragm tend to excite it; but exacerbations, of a character closely resembling distinct paroxysms, are often observed, when the pain becomes lancinating and causes impeded respiration. The efforts of coughing, sneezing, or exertion of any kind which involves the muscles of the trunk, are rendered difficult and painful. Muscular debility and tremblings in the upper extremity are sometimes present. As this type of neuralgia often accompanies organic lesions of the heart, concomitant phenomena, such as cardiac palpitation, angina pectoris, etc., may coexist.

Although phrenic neuralgia is not infrequently an independent and primary disease in the anæmic and nervous class of patients (especially after exposure to cold, dampness, etc.), still it is far more commonly met with as a concomitant affection of some other disease. It is therefore always best to look for the existence of heart lesions, aneurism of the mediastinum, Basedow's disease, angina pectoris, and diseases of the liver and of the spleen, since they may explain the phrenic symptoms and modify the prognosis.

The close resemblance which this type of neuralgia has to attacks of diaphragmatic pleurisy, pericarditis, uncomplicated angina pectoris, and gastralgia, makes the situation of the diagnostic points of tenderness an important factor in the discrimination.

Violent spasmodic contractions of the diaphragm, termed *clonic spasm* or "*hiccough*," are accompanied by an inspiratory sound, interrupted by a sudden spasm of the constrictors of the glottis, and followed by a short expiration. The symptoms produced by this condition depend upon the intensity and duration of the attack. In severe cases there may be pain, embarrassment of speech, dyspnoea, and retraction of the epigastric region. The causes of hiccough may be classed under three heads: 1, those of direct irritation of the

phrenic, as occurs in the case of mediastinal tumors, aneurism of the arch, pneumonic or pleuritic inflammation, pressure from pleuritic effusion, etc. ; 2, those of a reflex nature, as in diseases of the urinary organs, the uterus, and the intestinal tract and the liver ; the irritation of biliary or renal calculi ; irritation of the pharynx, œsophagus, and stomach ; and diseases of the peritonæum ; 3, those of central origin, as occurs in hysteria, local, brain, or spinal diseases, blood poisoning (as in the fevers, cholera, dysentery, etc.), after emotional excitement, and from the general anæmia of nerve centers after hæmorrhage. You can see from this list of causes that the symptom of hiccough, if occurring late in connection with any form of disease, may be a most serious symptom.

*Tonic spasm of the diaphragm* is a rare form of disease. It has been called "diaphragmatic tetanus." The symptoms of this obscure affection have been developed through the experiments of Duchenne upon animals, and the careful observations of Valette, Fischl, Vigla, Oppolzer, Duchenne, and others upon man.

The patient is at once markedly asphyxiated, the liver is displaced downward by the contracted diaphragm ; the lower half of the thorax is enlarged and rendered immovable ; the inspirations are extremely short, and the expirations are noisy and prolonged. The face shows the evidences of anxiety and cyanosis ; the pulse is slow and diminished in volume ; and the voice is monotonous in tone, and often interrupted. Acute pains pervade the lower regions of the thorax, and shoot over the epigastrium. While one case seems to have ended fatally, all other reported cases have recovered.

*Paralysis of the diaphragm* may occur as a symptom of hysteria, lead poisoning, the advanced stages of progressive muscular atrophy, and paralysis of the bulbar nuclei. It may be also produced by the extension of inflammation in cases of pleurisy or peritonitis, thus creating exudation or suppuration in the substance of the muscle.

When this condition is fully developed, the abdominal walls are retracted during each inspiratory effort, while the

lower portion of the thorax is distended ; in expiration, however, the hypochondriac region, as well as the epigastric, sinks in, while the chest becomes diminished in its capacity. The respiration becomes slow and difficult, and speaking or muscular movements increase the embarrassment of this function. The voice is usually enfeebled, and may be entirely lost. The liver tends to rise in the chest, during inspiration, rather than to be displaced downward into the abdomen.

#### THE FOUR LOWER CERVICAL NERVES.

As was the case with the four upper nerves, which escape from the cervical portion of the spinal cord, the four lower divide into anterior and posterior divisions, as soon as they escape from the spinal foramina. The *anterior divisions* of each join to form the brachial plexus of nerves, which sends filaments of distribution to the neck, shoulder, upper extremity, and side of the thorax. The *posterior divisions* do not form a plexus,<sup>1</sup> but are separately distributed to the semi-spinalis, complexus, splenius, and trapezius muscles, and then send twigs to the integument<sup>2</sup> over these muscles, viz., over the region of the spine in the lower part of the neck.

The following table<sup>3</sup> will assist you in mastering the construction of the brachial plexus, and in understanding the plates of that complicated mesh-work of nerves. It may be well to remark that the diagrams of this plexus are seldom alike in the works of any two authors ; since, if they are intended to be accurate representations of the parts, they naturally tend to show the great dissimilarities which exist in the union of the different nerves which help to form it, while, if purely diagrammatic, no two authors would naturally follow the same schematic plan. Notwithstanding the dissimilarities which exist, there are, however, points of resemblance

<sup>1</sup> In the case of the three upper cervical nerves, an anastomosis of the posterior divisions occurs, to which Cruveilhier applies the term "posterior cervical plexus."

<sup>2</sup> See researches of Cruveilhier, Sappey, Hirschfeld, and others.

<sup>3</sup> Modified from tables in "The Essentials of Anatomy" (Darling and Ranney). G. P. Putnam's Sons, New York, 1880.

in them all, which consist in the delineation of an outer cord formed by the fifth, sixth, and seventh cervical nerves; an inner cord formed by the eighth cervical and first dorsal nerves; and a middle cord formed by a branch from both the outer and the inner, which subsequently unite.

## THE BRACHIAL PLEXUS.

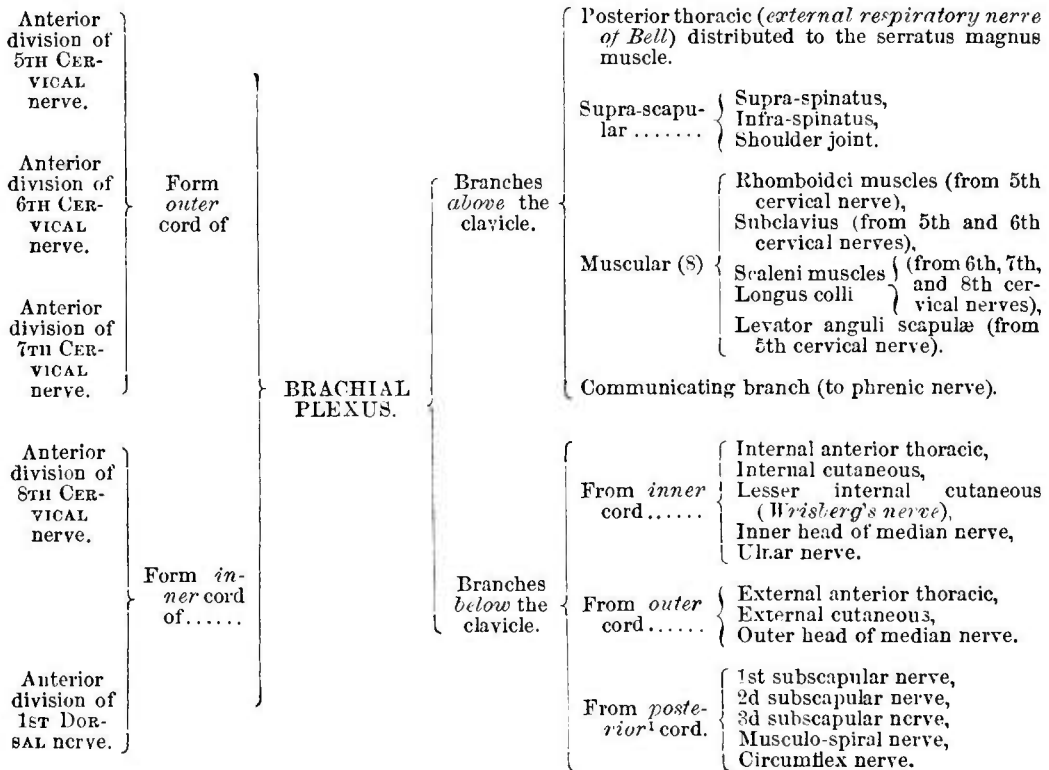

This table and the diagram (after Gray) shown on the next page will help to make clear the method of construction of the brachial plexus, and the main branches which are given off from its different portions. It will be perceived that the branches of distribution are subdivided into *two sets*: those given off above the line of the clavicle and those given off below that line. The former set, if traced, will be seen to supply the muscles of the scapular region, some of the muscles of the neck, the serratus magnus (a muscle of respiration), and the subclavius. The branch of communication which helps to complete the formation of the phrenic nerve is also shown to arise from the fifth cervical nerve. The branches

<sup>1</sup> The *posterior cord* of the brachial plexus is formed by a branch from both the inner and outer cord.



which are given off below the line of the clavicle are distributed to the muscles of the upper extremity, and will be considered in detail in subsequent tables and diagrams.

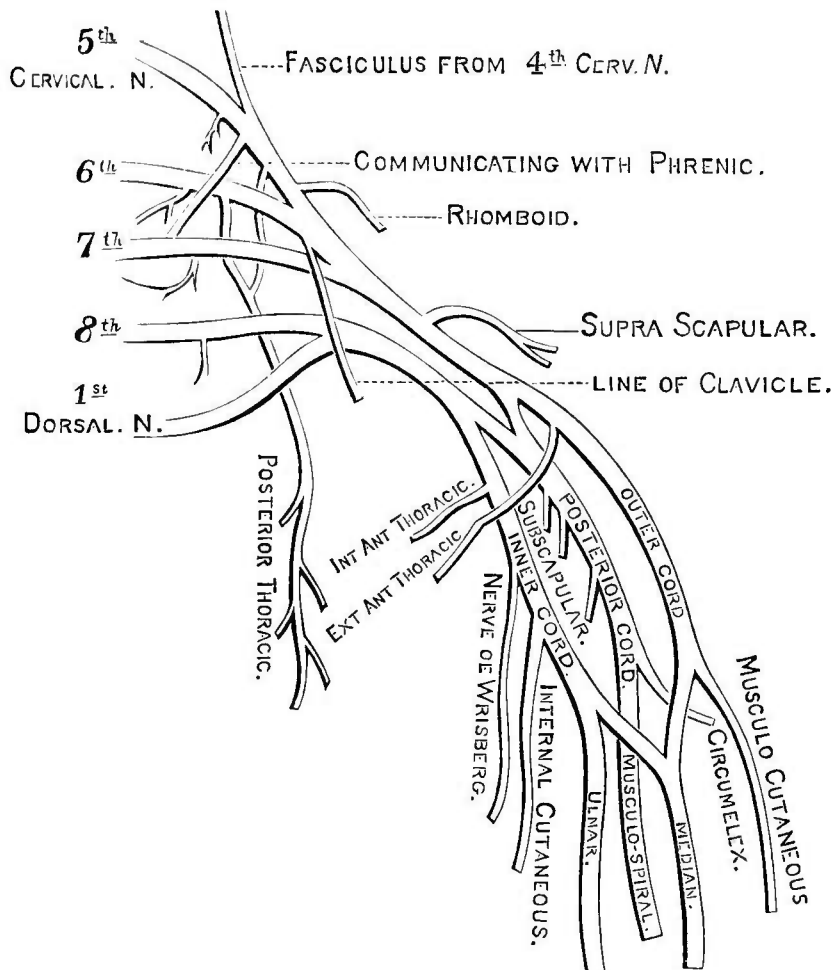

FIG. 136.—A diagram of the brachial plexus and its branches. (Gray.)

Varieties, more apparent than real, are frequently met with in the formation of this plexus,<sup>1</sup> resulting from the corresponding increase or diminution in the size of the above anastomotic branches, and of the portion of the posterior cord which is given off by the seventh cervical nerve. The posterior cord may be occasionally formed by the seventh cervical nerve alone; while it may in some instances be formed by two bands, arising from the fifth and sixth nerves, without any assistance from the seventh nerve. Other variations may re-

<sup>1</sup> The dissections and paper of R. C. Lucas upon this point ("Guy's Hospital Reports" 1875) and the description of this plexus by Henle seem to confirm each other as regards the abnormalities of its formation.

sult from the branches of the plexus being given off at a higher or lower point than usual, and also by the seventh nerve joining the plexus at a higher or lower level than normal.

The brachial plexus, as a whole, is broad between the middle and anterior scalmi muscles, at which point it lies immediately *above* the second portion of the subclavian artery; it is contracted in size opposite the clavicle, where the outer and inner cords lie on the *outer side* of the third portion of the subclavian artery; and, in the axilla, it again expands, the three cords bearing the relation to the second portion of

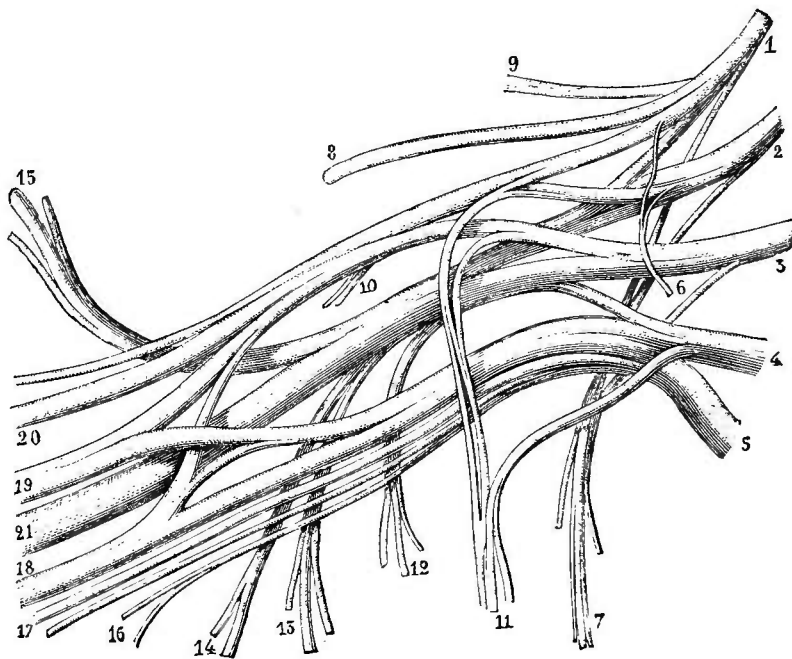

FIG. 137.—*Anterior branches of the four last cervical and the first dorsal nerves.* (Hirschfeld.)

- 1, anterior branch of the fifth cervical, ordinarily united with the sixth cervical before dividing; 2, anterior branch of the sixth cervical; 3, anterior branch of the seventh cervical; 4, anterior branch of the eighth cervical; 5, anterior branch of the first dorsal; 6, origin of the subclavian nerve; 7, posterior thoracic arising from the fifth, sixth, and seventh cervical nerves; 8, supra-scapular; 9, common trunk of the branches supplying the levator anguli scapulae and the rhomboidei; 10, superior subscapular; 11, anterior thoracic branches; 12, inferior subscapular; 13, long subscapular; 14, separate branch to the teres major; 15, circumflex nerve; 16, lesser internal cutaneous; 17, internal cutaneous; 18, ulnar; 19, median; 20, musculospiral; 21, radial.

the axillary artery which their names designate. Thus it will be perceived that this plexus has important surgical relations with the last two portions of the subclavian artery and the two upper portions of the axillary artery. The terminal branches of the three cords are also in relation with the third

portion of the axillary artery, since they almost entirely surround it.

The preceding cut of the brachial plexus, taken from the superb anatomical work of Sappey, will enable you to con-

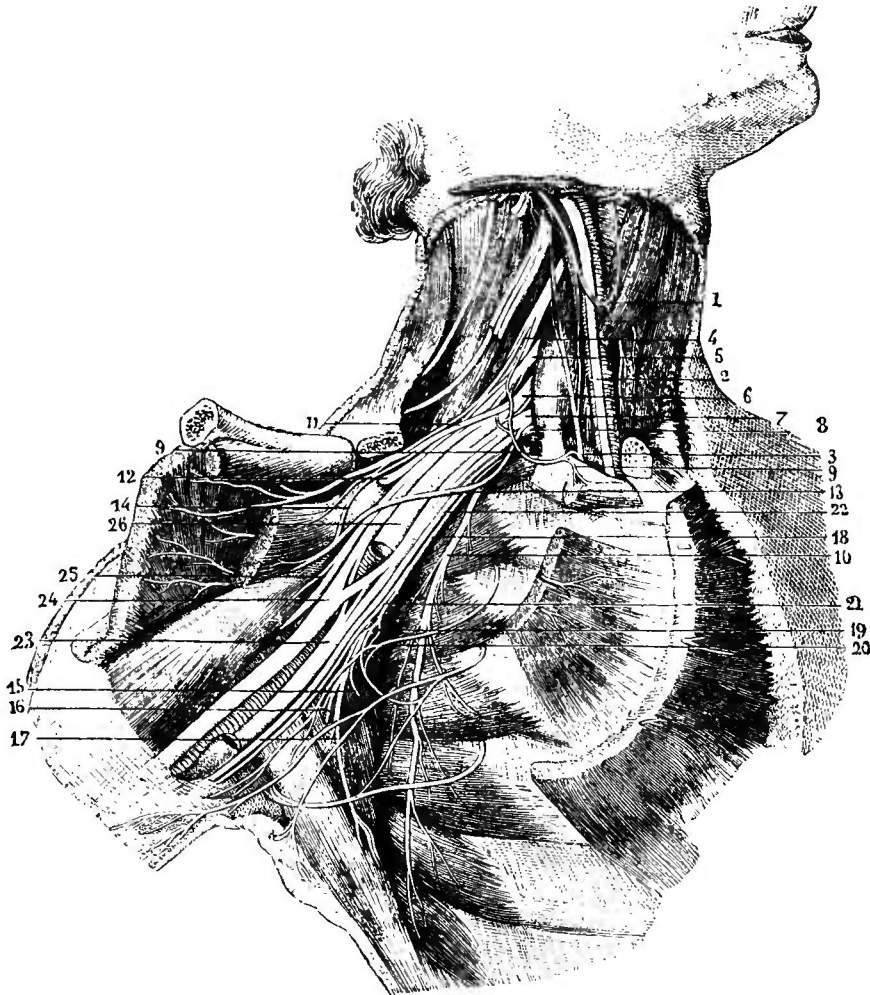

FIG. 138.—Collateral branches of the brachial plexus. (Hirschfeld.)

- 1, arcade formed by the anastomosis of the descending branch of the hypo-glossal with the internal descending branch of the cervical plexus; 2, pneumogastric nerve; 3, phrenic nerve; 4, anterior branch of the fifth cervical pair; 5, anterior branch of the sixth cervical pair; 6, anterior branch of the seventh cervical pair; 7, 8, anterior branch of the eighth cervical pair and first dorsal pair; 9, 9, branch to the subclavius muscle; 10, long thoracic nerve; 11, nerve to the pectoralis major giving off a filament to anastomose with that supplying the pectoralis minor; 12, supra-scapular nerve passing under the coracoid ligament; 13, nerve supplying the pectoralis minor muscle; 14, branch supplying the pectoralis minor muscle given off from the one which supplies the pectoralis major muscle; 15, inferior branch of the subscapularis; 16, nerve to the teres major muscle; 17, nerve to the latissimus dorsi muscle; 18, accessory branch of the internal cutaneous; 19, an anastomosis of this branch with the perforating branch of the second intercostal nerve; 20, ramification of the accessory branch of the internal cutaneous nerve; 21, internal cutaneous nerve; 22, ulnar nerve; 23, median nerve; 24, musculo-cutaneous nerve; 25, radial nerve.

trast the diagrammatic plate of Gray <sup>1</sup> with the actual representation of the parts under consideration.

<sup>1</sup> See page 380 of this volume.

## COMMUNICATIONS OF THE PLEXUS.

The brachial plexus communicates with the *cervical* plexus by a branch which joins the fourth and fifth nerves, and by one head of the phrenic nerve. It also sends filaments to the *middle and inferior cervical ganglia* of the sympathetic, and, in this way, anastomoses with the corresponding filaments of the *first dorsal nerve*.

## NERVES OF THE UPPER EXTREMITY.

BRANCHES OF THE OUTER CORD OF THE BRACHIAL PLEXUS.<sup>1</sup>

Branches of the OUTER CORD of the brachial plexus.	(1) EXTERNAL ANTERIOR THO- RACIC . . . . .	} Pectoralis major.	{	Muscular	{	Coraco-brachialis,		
						Biceps,		
						Brachialis anticus.		
						<i>Integument</i> of the front of forearm,		
	(2) EXTERNAL OF MUSCULO-CU- TANEOUS . . . . .	} Anterior	branch.	{	{	<i>Integument</i> of ball of thumb,		
						Joins with the radial nerve.		
						<i>Integument</i> of radial side of back of fore- arm.		
						Joins with the radial nerve.		
	} Posterior	branch.	{	{	{	Joins with the external cutaneous branch of the musculo-spiral nerve.		
						Articular	} To elbow joint.	
(3) MEDIAN . . .	} In fore- arm.	{	{	{	Muscu- lar.			
					} Anterior interosse- ous.	{	Pronator radii teres,	
							Flexor carpi radialis,	
							Palmaris longus,	
					} Palmar cutane- ous.	{	{	Flexor sublimis digitorum.
								Flexor longus pollicis,
					} In the hand . . .	{	{	Flexor profundus digitorum (its outer half),
								Pronator quadratus.
					} External branch.	{	{	<i>Integument</i> of palm,
								<i>Integument</i> of ball of the thumb.
} Internal branch.	{	{	Abductor pollicis,					
			Opponens pollicis,					
			Flexor brevis pollicis (outer head).					
} Digital to thumb (palmar sur- face),	{	{	<i>Digital</i> to index finger (outer side).					
			<i>Digital</i> to contiguous sides of index, middle, and ring fin- gers,					
} Filaments to the two outer lumbricales muscles.	{	{						

<sup>1</sup> Modified from a table in "The Essentials of Anatomy" (Darling and Ranney). G. P. Putnam's Sons, New York, 1880.

BRANCHES OF THE INNER CORD OF THE BRACHIAL PLEXUS.<sup>1</sup>

Branches of the INNER CORD of the brachial plexus.	(1) INTERNAL AN- TERIOR THORAC- IC.	{	Both pectoral muscles (since its filaments lie above and underneath the pectoralis minor muscle).			
			(2) INTERNAL CU- TANEOUS.	{	Anterior branch. { <i>Integument</i> of the anterior surface of the inner side of the forearm as low as the wrist.	
	Posterior branch. { <i>Integument</i> of the posterior surface of the inner side of the forearm to near the wrist.					
	(3) LESSER IN- TERNAL CUTA- NEOUS. (Wris- berg.)	{	May, occasionally, be wanting (the intercosto-humeral nerve taking its place).			
			<i>Integument</i> of the posterior surface of the lower third of the arm (joining with the intercosto-humeral nerve and the posterior branch of the internal cutaneous nerve).			
	(4) ULNAR.	{	In the forearm.	Articular (to elbow joint)—several small filaments.	{	
				Muscular.		Flexor carpi ulnaris, <i>Inner half</i> of flexor profundus digitorum.
				Palmar cutaneous.		<i>Integument</i> of front of wrist and palm of hand.
				Dorsal cutaneous.		<i>Integument</i> at back of wrist and one and one half fingers on inner side of dorsal surface of hand.
		{	In hand.	Articular.	To wrist joint.	{
Superficial branches.				Palmaris brevis, <i>Integument</i> of inner one and one half fingers on palm.		
Deep branches.				Muscles of little finger, Interossei muscles,		
				The <i>two inner</i> lumbricales, Adductor pollicis, Flexor brevis pollicis ( <i>inner head</i> ).		

The accompanying tables will afford us a better conception of the distribution of the branches of the three *main cords* of the brachial plexus than a long verbal description; while they will also enable us, in studying the practical points suggested by the distribution of each branch, to use the eye as well as the intelligence in following the subsequent lectures. It is often impossible for one, not previously familiar with the detail of the nerve distribution of any part, to appreciate all the deductions which may be drawn by an author, without much labor in reviewing the preceding text of the work which he may be endeavoring to master; and I believe that, in fol-

<sup>1</sup> Modified from a table in "The Essentials of Anatomy" (Darling and Ranney). New York: G. P. Putnam's Sons, 1880.

lowing these lectures, these tables will greatly assist in such review, as well as in affording you a chart which can be used as a guide to the preliminary study required in your future attempts to master other treatises.

BRANCHES OF THE POSTERIOR CORD OF THE BRACHIAL PLEXUS.<sup>1</sup>

Branches of the POSTERIOR CORD of the brachial plexus.	(1) SUBSCAPULAR NERVES.	The <i>upper</i> , or 1st.	}	Subscapular muscle.	
		The <i>long</i> , or 2d.	}	Latissimus dorsi.	
		The <i>lower</i> , or 3d.	}	Teres major.	
	(2) CIRCUMFLEX.	Superior branch.	}	Deltoid. <i>Integument</i> over the back of the shoulder.	
		Inferior branch.	}	Teres minor, Deltoid (posterior portion), <i>Integument</i> over the outer part of the shoulder.	
	(3) MUSCULO-SPIRAL.	<i>Muscular</i> branches.	}	Triceps, Anconeus, Brachialis anticus, Supinator longus, Extensor carpi radialis longior.	
		<i>Cutaneous</i> branches.	}	<i>Integument</i> of the inner and posterior portions, and the outer and anterior portions of arm, <i>Integument</i> of the outer aspect of the forearm.	
	(3) MUSCULO-SPIRAL.	RADIAL NERVE.	External branch.	}	<i>Integument</i> of outer side of thumb. <i>Integument</i> of ball of the thumb.
			Internal branch.	}	<i>Integument</i> of 3½ fingers on radial side of dorsum of hand.
		POSTERIOR INTEROSSEOUS NERVE.	}	All muscles on back of forearm except three { Anconeus, Supinator longus, Ext. carp. rad. long. Filaments to the wrist joint.	

There are still some points pertaining to the individual branches of the brachial plexus which can not be shown in a tabular arrangement, but which are, nevertheless, important, as they will enable you to better understand the surgical and medical aspects which are constantly brought to the attention of the active practitioner. In order to avoid, as far as possible, any important omissions, and to afford you a more practical insight into the uses to which a knowledge of the nerves can be applied, I will ask you to follow me in a review of the

<sup>1</sup> Taken, by permission of the publishers, from "The Essentials of Anatomy" (Darling and Ranney). New York: G. P. Putnam's Sons, 1880.

nerves of the upper extremity, using the tabulated charts as a means of reference, should you become confused as to the source of origin of the nerve under discussion, or fail to grasp its subdivisions and their distribution.

#### THE ANTERIOR THORACIC NERVES.

These two nerves are termed the external and the internal, since one arises from the outer cord, and the other from the inner cord of the brachial plexus. The external is sometimes also called the superficial, since it crosses in front of the axillary artery and vein to reach the under surface of the great pectoral muscle;<sup>2</sup> while the internal is also called the deep, since it passes between the same artery and its accompanying vein, to be distributed to the under surface of both the great and small pectoral muscles. The two nerves are connected with each other by a loop situated on the inner side of the axillary artery. It is probable (following the axiom of Hilton as to the cutaneous distribution of nerves) that the skin over the pectoral region receives filaments from these nerves as well as from the intercostal nerves. As the pectoral muscles are agents in effecting inspiration, when any impediment exists to breathing, as in asthma, etc., these nerves might be classed as respiratory in function, although that is not their most frequent use.

#### THE EXTERNAL CUTANEOUS OR MUSCULO-CUTANEOUS NERVE.

This nerve and its branches will be found given in the table of the subdivisions of the outer cord<sup>3</sup> of the brachial plexus. It passes through the belly of the coraco-brachialis muscle (hence the name "musculo-cutaneous"), then between the biceps and the brachialis anticus muscles, to a point slightly above the external condyle of the humerus, where it *perforates the deep fascia* and divides into its cutaneous

<sup>1</sup> See pages 382, 383, and 384 of this volume.

<sup>2</sup> The anterior fibers of the deltoid muscle are said to be supplied chiefly by the thoracic nerves, as revealed by clinical facts.

<sup>3</sup> See page 382 of this volume.

branches beneath the median cephalic vein. Now, a reference to the table of its distribution will show you that three muscles, which move the arm, are supplied with motor power by means of this nerve ; hence we should expect to find that filaments would be sent to both the shoulder and elbow joints, which these muscles move, and I am inclined to think that

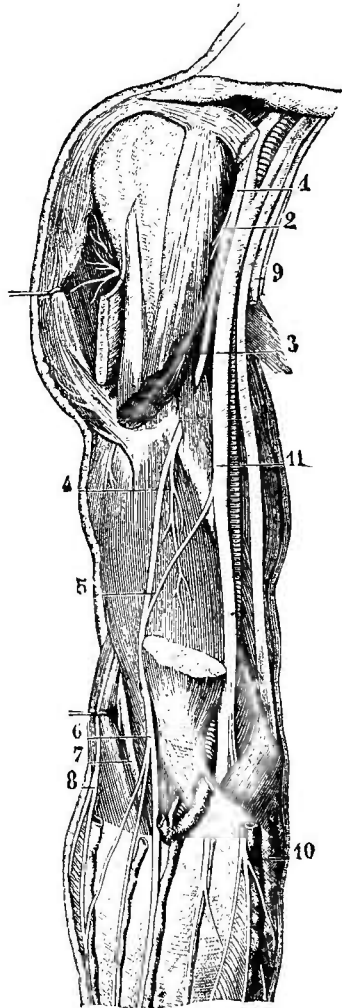

FIG. 139.—*Brachial portion of the musculo-cutaneous, median, and ulnar nerves.* (Sappey.)

- 1, musculo-cutaneous nerve ; 2, branch to the coraco-brachialis muscle ; 3, branch to the biceps muscle ; 4, branch to the brachialis anticus ; 5, anastomotic filament which it receives from the median nerve ; 6, division of this nerve where it crosses the aponeurosis of the arm ; 7, musculo-spiral nerve passing between the brachialis anticus and supinator longus muscles ; 8, external cutaneous branch of the musculo-spiral nerve ; 9, trunk of the internal cutaneous dividing just below its origin, thus giving off an accessory branch ; 10, anterior or ulnar branch of this nerve ; 11, brachial portion of the median and ulnar nerves.

small filaments to the former joint do actually exist, although they are not mentioned in the usual text-books upon anatomy.



We would also expect that any injury<sup>1</sup> to the trunk of this nerve would be followed by paralysis or atrophy of these three muscles, as well as by a condition of hyperæsthesia or anæsthesia in the portions of integument supplied by its terminal filaments (the radial side of the forearm and the ball of the thumb); provided that the nerve be irritated or only partly destroyed, as shown in the first case, or entirely destroyed, in which case the latter condition should ensue.

It is a well-recognized surgical fact that an inflamed condition of the elbow joint tends to create flexion of the forearm, by a contracted state of the brachialis anticus and biceps muscles; and the distribution of the musculo-cutaneous nerve<sup>2</sup> to the joint, as well as to these two muscles, enables us now to understand why the irritation of the articular branches of this nerve should manifest itself in a contracted state of the muscles supplied by it.

The relation of this nerve to the median-cephalic vein will also explain why *renesection* at the elbow is liable to be followed by the so-called "bent arm." This fact, which has been explained by some authors as the result of an injury done to the fascia, is much more intelligently, to my mind, attributed by Hilton to an injury done to the filaments of the musculo-cutaneous nerve, resulting in a sympathetic contraction of the flexors of the elbow.

An exostosis growing from the humerus, or the existence of a tumor in the region of the course of this nerve, might cause a similar rigidity of the elbow joint, accompanied, moreover, by a pain which would follow the course of the nerve to its terminal filaments. It has been suggested, by the author above quoted,<sup>3</sup> to apply anæsthetics over the course of this nerve in order to insure relaxation of the

<sup>1</sup> Hilton reports a case where an officer in the navy presented a very marked instance of injury done to this nerve alone. It caused paralysis and atrophy of the three muscles supplied by the musculo-cutaneous nerve; but a perfect recovery took place in about two years, in spite of the atrophy which at first existed.

<sup>2</sup> The ulnar nerve also furnishes filaments to the elbow joint and supplies the flexor muscles of the forearm. This may also tend to explain the surgical fact that flexion follows inflammation of the elbow.

<sup>3</sup> Hilton, *op. cit.*

muscles supplied by it when the elbow is thus flexed. Many cases may be cited from different surgical and medical authors, to illustrate the diagnostic value of this and other nerves, in determining accurately the seat and character of disease which is producing distress to the patient; but, as this aid to diagnosis has already been discussed at some length in previous lectures, I will simply mention it as an incentive to anatomical study.

The cutaneous distribution of this nerve will be made clear by referring to the diagram which I now show you.<sup>1</sup> The clinical value of the cutaneous nerves has already been referred to in previous lectures.<sup>2</sup> It will therefore suffice to again mention, in this connection, that hyperæsthesia, local pain, local points of tenderness, and anæsthesia have often a most direct and positive bearing upon diagnosis; and the *axioms* given in the first lecture upon the spinal nerves will prove most valuable as guides to the proper appreciation of their significance.

It may strike some of you who have thought deeply concerning the peculiarities of nerve distribution, that this nerve ought to stop at the elbow, since it has supplied all of its muscles before it reaches that point, and has, therefore, apparently performed its function; and this feeling will possibly be strengthened by the axiom given you in a previous lecture,<sup>3</sup> viz., that a nerve is always associated with that portion of the integument which covers the *points of insertion* of the muscles to which it furnishes motor power. If you will examine closely, however, into the insertion of the biceps muscle, you will observe that it is intimately connected with the *fascia* of the forearm—so intimately that this fascia is, in reality, an inherent part of the insertion of that muscle. This, then, confirms not only the truth of the general axiom given by Hilton,<sup>4</sup> but also explains to the inquiring mind why this nerve should be continued downward to the wrist, since it has to do so in order to cover the skin over one of the most impor-

<sup>1</sup> See page 396 of this volume.

<sup>2</sup> See pages 359 and 360 of this volume.

<sup>3</sup> See page 359 of this volume.

<sup>4</sup> *Op. cit.*

tant points of insertion of a muscle which it controls. Other facts in the anatomy of the forearm seem to still more beauti-

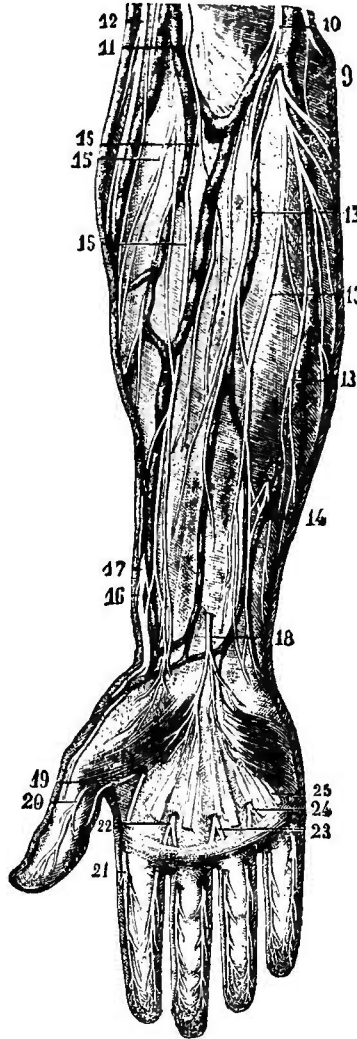

FIG. 140.—*Cutaneous nerves of the anterior surface of the forearm and hand.* (Hirschfeld.)

9, epi-trochlear branch from the musculo-spiral nerve anastomosing by a division with the anterior branch of the same nerve; 10, 10, anterior branch of the internal cutaneous of the arm dividing into several branches, some of which pass in front of and others behind the median basilic vein; 11, 11, musculo-cutaneous nerve crossing the aponeurosis of the arm outside of the tendon of the biceps muscle; 12, 12, divisions of the external cutaneous branch of the radial distributing themselves to the skin of the posterior portion of the forearm; 13, 13, 13, divisions which the anterior branch of the internal cutaneous furnishes to the forearm; 14, anastomosis of one of these divisions with a perforating branch of the ulnar nerve; 15, 15, 15, terminal divisions of the musculo-cutaneous nerve; 16, anastomosis of one of these divisions with 17, the terminal anterior branch of the radial nerve; 18, palmar cutaneous branch of the median; 19, internal branch of distribution to the thumb; 20, external branch of distribution to the same; 21, external branch of distribution to the index finger; 22, trunk of the branches of distribution to the internal side of the index and external aspect of middle fingers; 23, common trunk of distribution to the internal side of the middle and external side of the ring fingers; 24, trunk of distribution to the internal side of the ring and external side of the little finger; 25, branch of distribution to the internal side of the little finger.

fully confirm this same general law. We see the musculo-spiral nerve sending a filament to nearly the same region as the musculo-cutaneous, because it supplies the supinator longus, which is situated upon the outer side of the forearm; while, again, the internal cutaneous nerve (which properly may be considered as a branch of the median, since it arises by a common head) supplies the skin of the inner side of the anterior surface of the forearm, for the evident reason that the muscles supplied by the median are extensively attached to this same fascia.

CLINICAL POINTS PERTAINING TO THE MUSCULO-CUTANEOUS  
NERVE.

A paralysis limited to this nerve is an unusual occurrence. It may be produced, however, by any form of injury or of local pressure which alone involves this nerve trunk, and it must be situated in the region of the coraco-brachialis muscle to create impairment of all of its filaments of distribution. Complete paralysis of this nerve causes total paralysis of the biceps and coraco-brachialis muscles, but only a partial loss of power in the brachialis anticus, since that muscle is also furnished with a filament derived from the musculo-spiral nerve. The skin of the outer border of the forearm is also rendered anæsthetic when this nerve is injured. As a result of paralysis of the muscles named, the power to *flex the forearm* upon the arm is greatly impaired, and would be totally lost if the supinator longus and a part of the brachialis anticus muscles were not capable of assisting that movement. These latter muscles, being supplied by the musculo-spiral nerve, still retain their power of contraction; hence the difficulty in performing flexion of the forearm is greater when the hand is supinated, as the supinator longus no longer acts to any great extent as a flexor. The seat of the anæsthesia is a valuable guide to the nerve affected, as the musculo-cutaneous

<sup>1</sup> The supinator muscle is an important aid in flexion of the forearm, when the *hand is pronated*; but it is of little value as a flexor after the function of supination has been performed by it.

neous nerve may possibly be involved, without any impairment of the other branches of the outer cord of the brachial plexus.

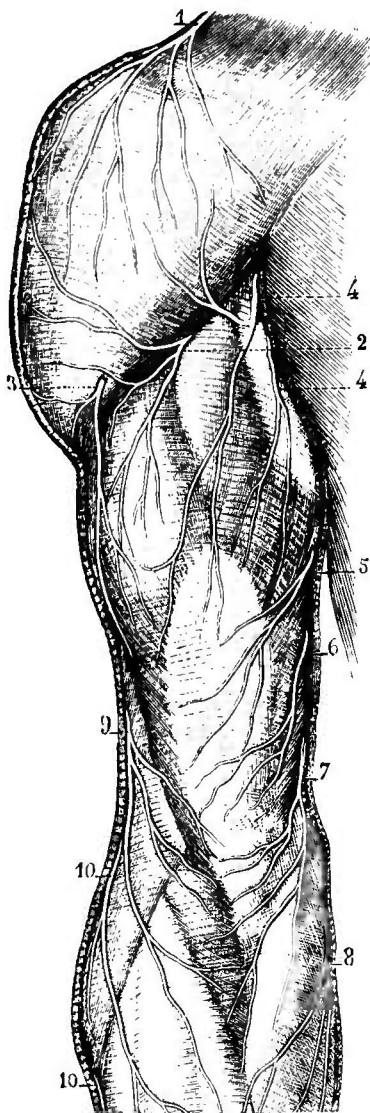

FIG. 141.—*Cutaneous nerves of the shoulder and posterior surface of the arm.* (Sappey.)

1, 1, terminal ramifications of the supra-acromial branch of the cervical plexus; 2, cutaneous branch of the axillary nerve; 3, another cutaneous branch of the same nerve traversing the posterior border of the deltoid; 4, terminal divisions of the perforating branch of the second intercostal nerve; 5, perforating branch of the third intercostal nerve; 6, internal cutaneous branch of the musculospiral nerve; 7, epitrochlear branch of the internal cutaneous nerve; 8, posterior division of the ulnar branch of the internal cutaneous; 9, external cutaneous division of the radial nerve; 10, 10, internal cutaneous filament of the radial nerve.

#### THE MEDIAN NERVE.

While this nerve arises by two heads, derived, respectively, from the outer and inner cords of the brachial plexus, it has been classed as a branch of the former.<sup>1</sup> This nerve bears a

<sup>1</sup> The reader is referred to the table on page 378 of this volume.

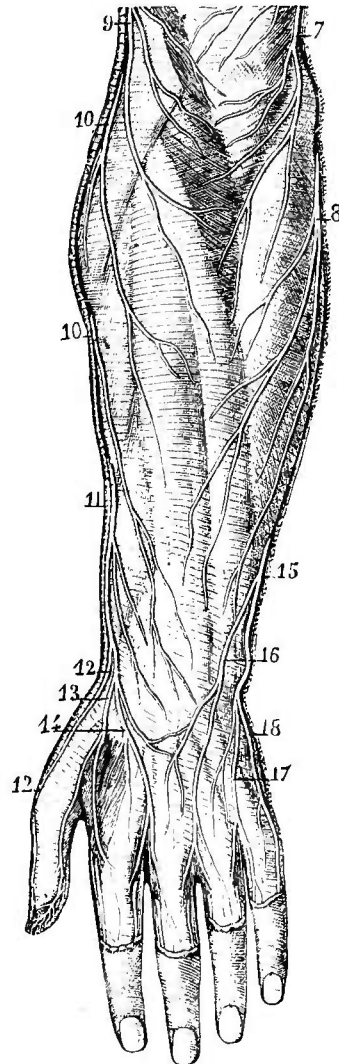

FIG. 142.—*Cutaneous nerves of the posterior surface of the forearm and hand.* (Sappey.)

7, epi-trochlear branch of the internal cutaneous nerve; 8, posterior division of the ulnar branch of the internal cutaneous; 9, external cutaneous division of the radial nerve; 10, 10, internal cutaneous filament of the radial nerve; 11, posterior division of the anterior terminal or cutaneous branch of the radial nerve; 12, first twig rising from this branch (it forms the external dorsal nerve of distribution to the thumbs); 13, second twig of the same division (it subdivides at the superior part of the first interosseous space—one of these divisions forms the internal dorsal cutaneous nerve of the thumb, the other ramifies in the skin of the dorsal face of the first phalanx of the index finger); 14, third branch, which descends into the second interosseous space, where it bifurcates (one of these divisions is lost in the internal half of the integument on the dorsal surface of the first phalanx of the index finger, and the other in the external half of the skin which covers the dorsal surface of the middle finger); 15, dorsal branch of the ulnar nerve; 16, external division of this branch anastomosing with one or two filaments of the anterior terminal branch of the radial passing directly into the third interosseous space, where it divides (one of these divisions ramifies in the internal half of the skin which invests the first phalanx of the middle finger, the other supplies the first phalanx of the ring finger); 17, second ramification of the same branch, which also bifurcates under the fourth interosseous space (one of these divisions ramifies in the skin on the dorsal surface of the first phalanx of the ring finger, the other forms the external dorsal nerve of distribution to the little finger); 18, internal dorsal nerve of distribution to the little finger.

*surgical relation to the brachial artery*, since it lies, at first, upon the outer side of that vessel, then crosses it, and, finally reaches its inner side at the bend of the elbow. It enters the forearm between the two heads of the pronator radii teres muscle, passes down the middle line of the anterior surface of the forearm till it reaches the annular ligament of the wrist, then passes underneath the arch formed by that ligament, when it becomes flattened and expanded in front of the flexor tendons in the palm of the hand, and finally terminates in branches to the muscles and integument of the hand and fingers. The table, which has been referred to in previous lectures,<sup>1</sup> will show, more plainly than a tedious verbal description, the parts supplied by this nerve in the different portions of its course. This nerve, in connection with its fellow, the ulnar nerve, furnishes motor power to all the flexor and pronator muscles of the forearm, and all the muscles of the palm of the hand; the median supplying all the muscles on the anterior surface of the forearm but one and a half (the flexor carpi ulnaris, and one half of the flexor profundus digitorum), and four and a half muscles on the radial side of the palm (as shown by the table). Now, as the ulnar nerve supplies all the rest of the muscles of the anterior surface of the forearm and hand, these two nerves may be considered as the *flexor and pronator nerves* of those regions.<sup>2</sup>

The *cutaneous distribution* of the median nerve is of interest, since it confirms the axiom<sup>3</sup> of nerve distribution to the integument over the muscles. We find that the median sends no cutaneous filaments to the dorsal surface of the thumb, but that it does supply its palmar surface; the dorsal surface is covered with the extensor tendons, which owe their motor power to the radial nerve, and the skin is therefore supplied from the same source. The sides of the *outer two and a half fingers* (those adjoining the thumb) are likewise supplied

<sup>1</sup> See page 382 of this volume.

<sup>2</sup> In speaking of the combined action of the median and ulnar nerves, Hilton says: "These nerves, together, supply all the flexors of the wrist joint, fingers and thumb, all the pronators of the radio-ulnar joints, and all the joints that these muscles move."

<sup>3</sup> See page 357 of this volume.

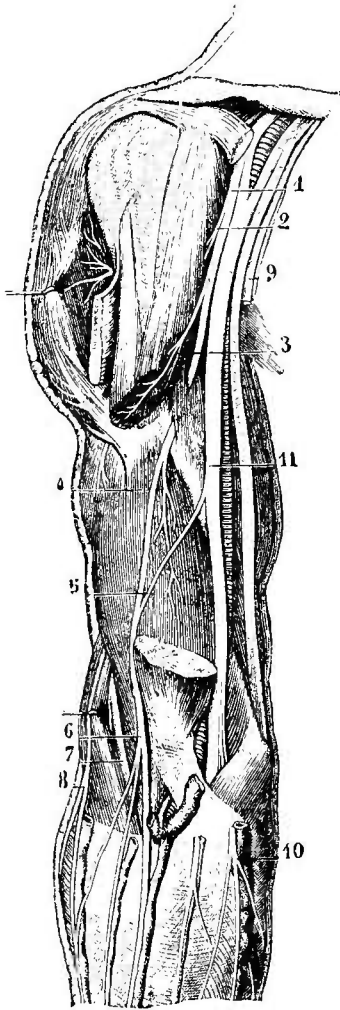

FIG. 143.—*Brachial portion of the musculocutaneous, median, and ulnar nerves.* (Sappey.)

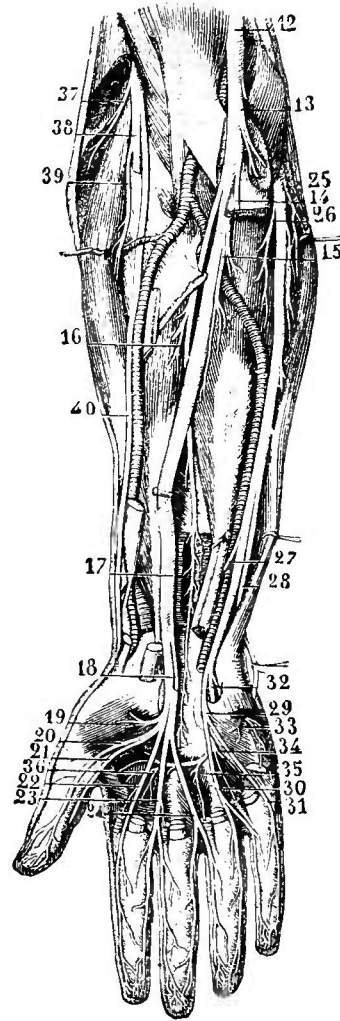

FIG. 144.—*Terminal portion of the median and ulnar nerves.* (Sappey.)

- 1, musculocutaneous nerve; 2, branch to the coraco-brachialis muscle; 3, branch to the biceps muscle; 4, branch to the brachialis anticus; 5, anastomotic filament which it receives from the median nerve; 6, division of this nerve where it crosses the aponeurosis of the arm; 7, musculospiral nerve passing between the brachialis anticus and supinator longus muscles; 8, external cutaneous branch of the musculospiral nerve; 9, trunk of the internal cutaneous dividing just below its origin, thus giving off an accessory branch; 10, anterior or ulnar branch of this nerve; 11, brachial portion of the median and ulnar nerves; 12, antebrachial portion, palmar and digital branches of the same nerve; 13, branch to the pronator radii teres; 14, trunk of these anterior muscular branches dividing and passing to the muscles to which they are distributed; 15, branch to the flexor profundus digitorum; 16, branch to the flexor longus pollicis; 17, anterior interosseous branch; 18, palmar cutaneous branch dividing just below its origin; 19, muscular branch of the thenar eminence; 20, external branch of distribution to the thumb; 21, internal branch of distribution to the same; 22, external branch of distribution of the index finger; 23, common trunk of the internal branches of distribution to the index finger and external to the middle finger; 24, internal trunk of distribution to the middle and external branch to the ring finger; 25, branch which the ulnar nerve furnishes to the flexor carpi ulnaris; 26, branches which the same nerve furnishes to the two internal fasciculi of the flexor profundus digitorum; 27, cutaneous and anastomotic filament of the ulnar nerve; 28, dorsal branch of this nerve; 29, its superficial palmar branch; 30, common trunk of the internal branch of distribution to the ring and external branch to



the little finger; 31; internal branch of distribution to the little finger; 32, deep palmar branch; 33, small branch to the hypo-thenar eminence; 34, branches to the muscles of the fourth interosseous space and the fourth lumbricalis muscle; 35, branches to the muscles of the third interosseous space and the third lumbricalis muscle; 36, branches to the adductor pollicis and muscles of the first and second interosseous spaces.

with integumentary branches from the median, the balance being supplied by similar branches of the ulnar nerve.

The two outer lumbricales muscles are enumerated in the preceding tables, as supplied by the median, and the remaining lumbricales and interossei muscles by the ulnar nerve. Now, the method of insertion of the tendons of these muscles (into the extensor tendon of the corresponding finger, on its dorsal surface) causes these muscles to *flex the proximal phalanx*, and *extend the two remaining phalanges*<sup>1</sup> of each finger. We find, therefore, that the nerve branches, which supply these muscles, send cutaneous filaments to the *dorsal surface* of the two terminal phalanges of the finger upon which the individual muscles act, thus apparently confirming the extensor action of the muscles, since the distribution of nerves, derived apparently from a flexor source, comprises a region covered by the extensor tendons of the fingers.

#### CLINICAL POINTS PERTAINING TO THE MEDIAN NERVE.

The median nerve is rarely affected with paralysis, to the exclusion of other nerves. If such a condition exists, it may probably be traced to some local injury, such as cuts, fractures of the humerus, the use of badly constructed crutches, contusions over the course of the nerve, gunshot wounds, unskillful venesection, local pressure from tumors, abscess, etc. It may possibly be due to rheumatism, neuritis,<sup>2</sup> neuromata, and central causes. The muscles of the ball of the thumb, which are supplied by this nerve, are frequently the seat

<sup>1</sup> Hunter, Cleland, Duchenne, Erb, and others consider the *interossei muscles* alone as extensors of the two terminal rows of phalanges. Clinical facts observed in lead paralysis and in division of the ulnar nerve seem to point to these muscles rather than to the lumbricales, although Hilton groups the lumbricales and interossei muscles as possessing a common function.

<sup>2</sup> This condition may follow any acute disease. It is one of the sequelæ of typhoid fever.

of a progressive muscular atrophy and its consequent paralysis.

From what has already been said respecting the distribu-

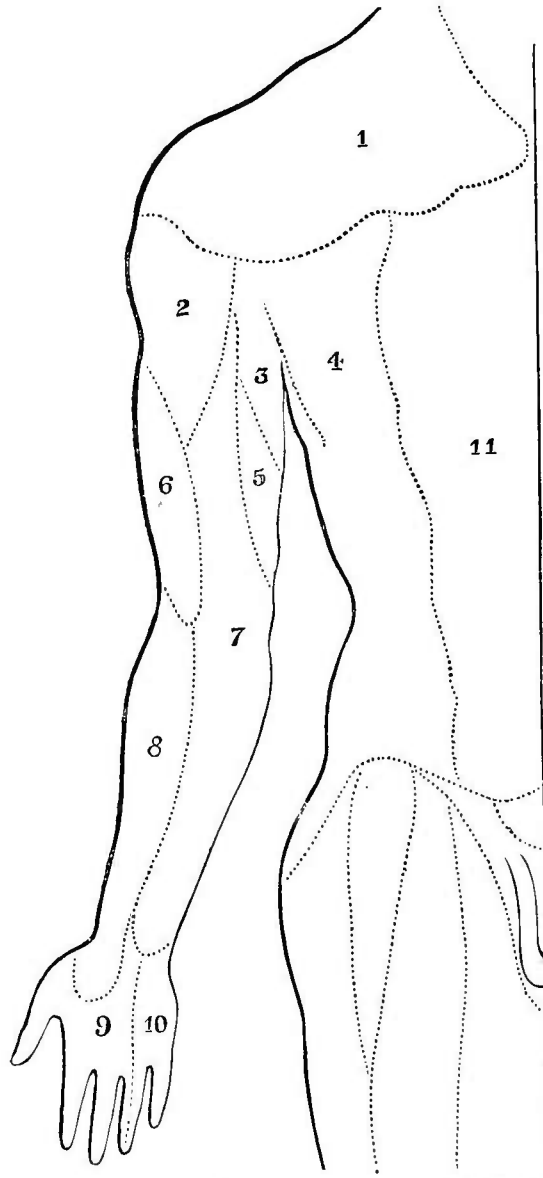

FIG. 145.—A diagram of the regions of cutaneous nerve distribution in the anterior surface of the upper extremity and trunk. (Modified from Flower.)

1, region supplied by the supra-clavicular nerve (branch of the cervical plexus); 2, region supplied by the circumflex nerve; 3, region supplied by the intercosto-humeral nerve; 4, region supplied by the intercostal nerve (lateral branch); 5, region supplied by the lesser internal cutaneous nerve (nerve of Wrisberg); 6, region supplied by the musculo-spiral nerve (external cutaneous branch); 7, region supplied by the internal cutaneous nerve; 8, region supplied by the musculo-cutaneous nerve; 9, region supplied by the median nerve; 10, region supplied by the ulnar nerve; 11, region supplied by the intercostal nerve (anterior branch).

tion of this nerve, we are prepared to understand why the common flexors of the fingers and those of the wrist should

show a loss of power, in case the median be injured, and the muscles of the thumb give evidence of the diseased condition. You will find, in such cases, that the second phalanges of all the fingers and the third phalanges of the index and middle' fingers can not be flexed, and that the thumb can not be flexed or brought into contact with the little finger. On the other hand, flexion of the first phalanx, with extension of the other two, can be performed in all the fingers by the aid of the interossei which are supplied by the ulnar nerve. The position of the thumb is peculiar; it is extended and adducted and thus closely applied to the index finger, as in the hand of the ape. The hand, when flexion at the wrist is attempted, is *strongly adducted* by the action of the flexor carpi ulnaris, as the antagonistic muscle of the radial side is paralyzed. The act of pronation of the hand is seriously impaired. The inner three fingers can be brought into a partially flexed condition, since the flexor profundus digitorum muscle is partly supplied by the ulnar nerve. These combined effects give to the hand and fingers, and especially to the thumb, a position so peculiar that paralysis of the median could hardly be mistaken by an anatomist for any other deformity. When the paralyzed muscles begin to show the results of atrophy, the deformity in the forearm and in the ball of the thumb will further assist in the diagnosis of this affection.

The anastomosis which exists between the cutaneous nerves of the forearm will possibly tend to explain the fact that complete destruction of the median, ulnar, or radial nerves may exist without any marked loss of sensibility in the regions supplied by the affected nerve. Should any such evidences of disordered sensibility be present, however, it will be confined to the region supplied by the nerve which is the seat of disease, or whose conducting power has been impaired from any cause. If the median, ulnar, or radial nerves be injured below the wrist, the absence of anastomosis tends to make the

<sup>1</sup> The flexor sublimis digitorum being completely paralyzed, and the flexor profundus digitorum being partially deprived of its motor power.

symptom of anæsthesia a constant and important guide to the nerve affected.

In severe paralysis of the median nerve, the first three fingers<sup>1</sup> not infrequently show trophic disturbances in the skin and nails, such as glossy fingers, ulceration, pemphigus vesicles, abnormal growth of hair, etc.

The relation of the median nerve to the brachial artery gives to it a surgical importance. It will be observed that the nerve lies, at first, to the outer side of that vessel; later on, it crosses it, and finally passes to the inner side of the artery in the region of the elbow.

#### THE INTERNAL CUTANEOUS AND LESSER INTERNAL CUTANEOUS NERVES.

These two nerves arise from the inner cord of the brachial plexus, in common with the inner head of the median and the ulnar nerves.

The *internal cutaneous nerve* accompanies the brachial artery, lying upon its inner side and in front of the lesser internal cutaneous nerve, till the basilic vein pierces the deep fascia, when the nerve accompanies the vein and soon divides into an anterior and posterior branch, whose distribution will be found given in preceding tables. It assists the coraco-humeral nerve in supplying the integument over the biceps muscle, and sends filaments to the skin of the forearm as low down as the wrist.<sup>2</sup>

The *lesser internal cutaneous nerve*, called also the nerve of Wrisberg,<sup>3</sup> has the same general origin as the preceding nerve, except that it arises slightly below it. Like the former nerve, it accompanies the brachial artery, lying upon its inner side and behind the nerve just described, and, after its escape from the fascia, it supplies the skin of the lower third of the arm,<sup>4</sup> becoming joined to the posterior branch of the internal

<sup>1</sup> Those adjoining the thumb. See figure on page 396 of this volume.

<sup>2</sup> See cut on page 396 of this volume.

<sup>3</sup> For the region of cutaneous distribution to this nerve, the reader is referred to the diagrammatic cuts on pages 389 and 396 of this volume.

<sup>4</sup> See Fig. 145 of this volume.

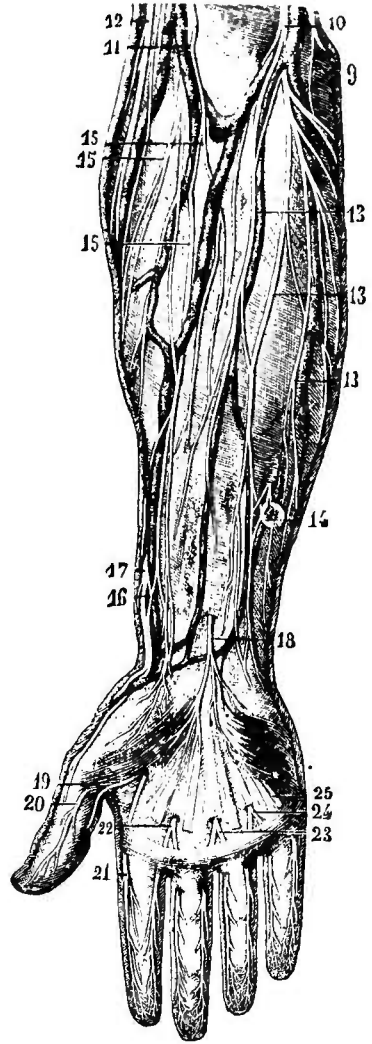
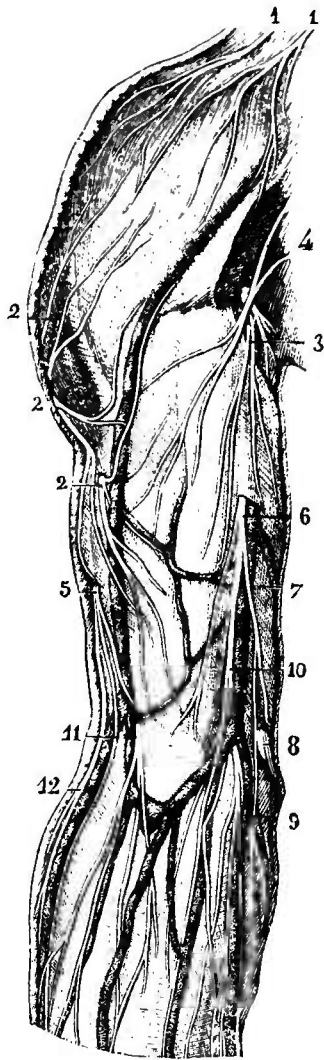

FIG. 146.—Cutaneous nerves of the shoulder and anterior surface of the arm. (Hirschfeld.)

FIG. 147.—Cutaneous nerves of the anterior surface of the forearm and hand. (Hirschfeld.)

1, 1, divisions of the supra-acromial branch of the cervical plexus ; 2, 2, 2, terminal ramifications of the cutaneous division of the circumflex nerve ; 3, division of the internal cutaneous nerve of the arm ; 4, small filament from the perforating branch of the second intercostal nerve ; 5, external cutaneous branch from the musculo-spiral nerve ; 6, internal cutaneous branch crossing the aponeurosis of the arm ; 7, epitrochlear branch of this nerve, anastomosing by a division with 8, the ulnar nerve, and 9, 9, with the anterior branch of the same nerve ; 10, 10, anterior branch of the internal cutaneous of the arm, dividing into several branches, some of which pass in front of and others behind the median-basilic vein ; 11, 11, musculo-cutaneous nerve crossing the aponeurosis of the arm outside of the tendon of the biceps muscle ; 12, 12, 12, divisions of the external cutaneous branch of the radial, distributing themselves to the skin of the posterior portion of the forearm ; 13, 13, 13, divisions which the anterior branch of the internal cutaneous furnishes to the forearm ; 14, anastomosis of one of these divisions with a perforating branch of the ulnar nerve ; 15, 15, 15, terminal divisions of the musculo-cutaneous nerve ; 16, anastomosis of one of these divisions with 17, the terminal anterior branch of the radial nerve ; 18, palmar cutaneous branch of the median ; 19, internal branch of distribution to the thumb ; 20, external branch of distribution to the same ; 21, external branch of distribution to the index finger ; 22, trunk of the branches of distribution to the internal side of the index and external aspect of middle fingers ; 23, common trunk of distribution to the internal side of the middle and external side of the ring fingers ; 24, trunk of distribution to the internal side of the ring and external side of the little finger ; 25, branch of distribution to the internal side of the little finger.

cutaneous nerve or to the intercosto-humeral nerve. The size of this nerve varies, as it is often supplanted by the intercosto-humeral<sup>1</sup> nerve, which is then of extremely large size. In this case the nerve of Wrisberg may be entirely wanting, and the intercosto-humeral nerve act independently of any communication with the brachial plexus.

#### THE ULNAR NERVE.

This nerve arises from the inner cord of the brachial plexus, in common with the internal cutaneous and the nerve of Wrisberg, as well as with the inner head of the median nerve. It bears a *surgical relation* with the third portion of the axillary artery and the upper part of the brachial artery, since it lies internally to and in close proximity with both; but it gradually separates from the brachial artery as it passes down the arm. It perforates the deep fascia of the arm in company with the inferior profunda branch of the brachial artery, and descends in a groove between the olecranon process of the ulna and the inner condyle of the humerus, until it enters the forearm by passing between the two heads of the flexor carpi ulnaris muscle. In the forearm, this nerve bears a relation with the ulnar artery, especially in the middle and lower thirds of that region; the artery lying upon the outer side of the nerve. At the wrist, this nerve winds around the outer side of the pisiform bone, crosses the annular ligament, and divides into its two terminal branches. The tabulated arrangement of the branches of distribution of the ulnar nerve<sup>2</sup> will show the muscles supplied by it, both in the forearm and hand. It is important to remember that this nerve gives filaments to both the elbow and wrist joints, and that its cutaneous branches are confined to the fingers and palm of the hand.

By a glance at the diagrammatic representation of the regions of the integument of the upper extremity, supplied by individual nerves (see Figs. 145 and 153), you will perceive that the ulnar nerve supplies the dorsal and palmar

<sup>1</sup> A branch of the second intercostal nerve.

<sup>2</sup> See page 383 of this volume.

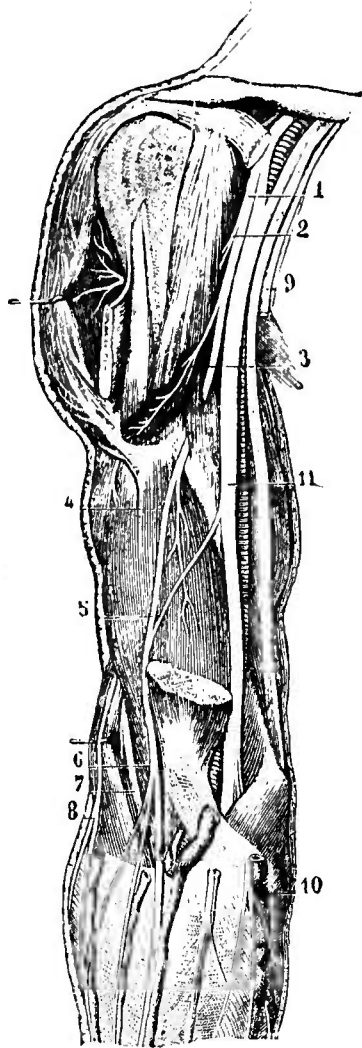

FIG. 148.—*Brachial portion of the musculocutaneous, median, and ulnar nerves.* (Sappey.)

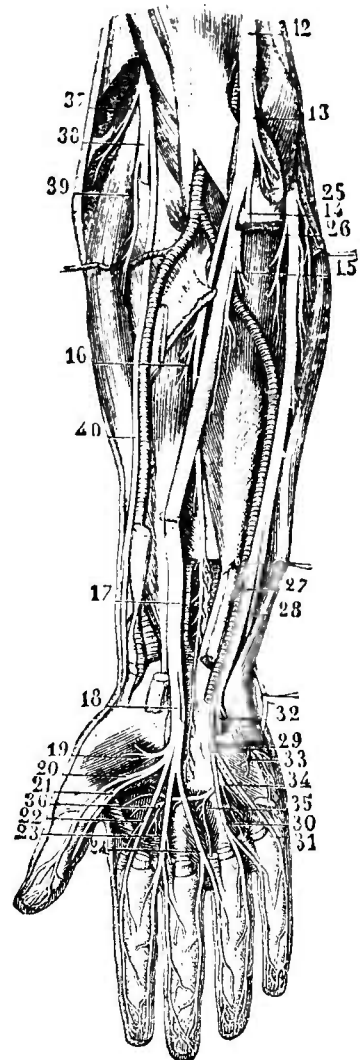

FIG. 149.—*Terminal portion of the median and ulnar nerves.* (Sappey.)

- 1, musculocutaneous nerve; 2, branch to the coraco-brachialis muscle; 3, branch to the biceps muscle; 4, branch to the brachialis anticus; 5, anastomotic filament which it receives from the median nerve; 6, division of this nerve where it crosses the aponeurosis of the arm; 7, musculospiral nerve passing between the brachialis anticus and supinator longus muscles; 8, external cutaneous branch of the musculospiral nerve; 9, trunk of the internal cutaneous dividing just below its origin, thus giving off an accessory branch; 10, anterior or ulnar branch of this nerve; 11, brachial portion of the median and ulnar nerves; 12, antebrachial portion, palmar and digital branches of the same nerve; 13, branch to the pronator radii teres; 14, trunk of these anterior muscular branches dividing and passing to the muscles to which they are distributed; 15, branch to the flexor profundus digitorum; 16, branch to the flexor longus pollicis; 17, anterior interosseous branch; 18, palmar cutaneous branch dividing just below its origin; 19, muscular branch of the thenar eminence; 20, external branch of distribution to the thumb; 21, internal branch of distribution to the same; 22, external branch of distribution of the index finger; 23, common trunk of the internal branches of distribution to the index finger and external to the middle finger; 24, internal trunk of distribution to the middle and external branch to the ring finger; 25, branch which the ulnar nerve furnishes to the flexor carpi ulnaris; 26, branches which the same nerve furnishes to the two internal fasciculi of the flexor profundus digitorum; 27, cutaneous and anastomotic filament of the ulnar nerve; 28, dorsal branch of this nerve; 29, its superficial palmar branch; 30, common trunk of the internal branch of distribution to the ring and external branch to

the little finger; 31; internal branch of distribution to the little finger; 32, deep palmar branch; 33, small branch to the hypo-thenar eminence; 34, branches to the muscles of the fourth interosseous space and the fourth lumbricalis muscle; 35, branches to the muscles of the third interosseous space and the third lumbricalis muscle; 36, branches to the adductor pollicis and muscles of the first and second interosseous spaces.

surfaces of the *inner one and a half fingers*, thus leaving three and a half fingers upon the palm for the median nerve, and three and a half fingers on the back of the hand for the radial nerve to supply. Thus the integument of the palm is as equally divided between these three nerves as could well be, as the ulnar has a total of three fingers (one and a half on both the palm and back of hand), and the other two nerves three and a half fingers each.

#### CLINICAL POINTS OF INTEREST PERTAINING TO THE ULNAR NERVE.

The superficial situation of this nerve in the arm, near the elbow and at the wrist, would seem to suggest that paralysis of this nerve would be a matter of common occurrence, as it is apparently exposed to injury. It is, nevertheless, infrequently affected with traumatic paralysis. The causes which reported cases show to have produced this condition include about the same list of accidents as mentioned in connection with paralysis of the median nerve; but sleeping upon the arm when placed beneath the head, the use of poorly constructed crutches, fractures and dislocations at the shoulder, tumors, contusions, wounds of all kinds, neuritis,<sup>1</sup> and neuromata are among the most common. Resting upon the elbow has been reported by Duchenne as a cause of this type of paralysis in a certain class of workmen; and the so-called "injury to the funny bone," which consists of a contusion over the seat of the ulnar nerve at the elbow, seems to justify the conclusion that this might easily be the seat of paralysis from long-continued or constant pressure.

It is a rule among surgeons, when operating about the elbow joint,<sup>2</sup> to guard against injury to the ulnar nerve, espe-

<sup>1</sup> Rosenthal states that this condition is most frequent after typhoid fever and acute diseases.

<sup>2</sup> This is especially important in *excision* of this joint, as the nerve is apt to be injured in raising the periosteum from the bone.



cially when the steps of the operation bring the knife in proximity to the inner condyle of the humerus.

As has been mentioned in connection with the median nerve, the ulnar, as well as the median nerve, may be considered as a pronator and flexor nerve of the wrist and a flexor nerve of the fingers, since the distribution of the two is confined exclusively to the anterior surface of the forearm and the palmar surface of the hand. The table of the branches of the ulnar nerve<sup>1</sup> will help us to readily appreciate the peculiarities of ulnar paralysis from a theoretical standpoint, and to properly interpret the phenomena when met in actual experience.

We can see, by reference to the table, that the flexor carpi ulnaris and the greater part of the flexor profundus digitorum muscles would be paralyzed, and that the muscles of the hypothenar eminence, as well as the interossei muscles of the hand, the two inner lumbricales, a part of the flexor brevis pollicis, and the adductor pollicis would be similarly affected. Now, the clinical evidences of this form of paralysis are in perfect accord with these facts. We find that the adduction of the hand is no longer performed in a perfect manner, since the flexor carpi ulnaris can no longer act in unison with the extensor carpi ulnaris; that flexion of the hand is performed imperfectly and by means of the flexor of the radial side of the forearm only, since that muscle is supplied by the median nerve; that the ability to move the little finger is almost entirely abolished; that complete flexion of the inner three fingers is rendered difficult and sometimes impossible; that the fingers can not be separated from each other, or compressed into a close lateral juxtaposition, owing to paralysis of the interossei muscles; and that both flexion of the first phalanx and extension of the two terminal phalanges of all the fingers are rendered impossible, for the same reason.

When the ulnar nerve is paralyzed *above the wrist*, so that the interossei and lumbricales are alone paralyzed, the hand

<sup>1</sup> See page 383 of this volume.

assumes a diagnostic attitude, the so-called "claw-hand," in which the extensor communis digitorum muscle extends the first phalanges of all of the fingers, while the other two rows of phalanges are flexed by the common flexor muscles of the fingers (the interossei and lumbricales being no longer able to flex the first row of phalanges or to extend the two other rows). This same condition of the hand may, however, be produced by a condition of progressive muscular atrophy of these muscles.

It must be remembered that this condition, if dependent upon ulnar paralysis alone, is more marked in the *two inner fingers* than in the three outer, since the lumbricales are supplied in part by the median nerve; and this clinical fact seems to stamp the action of the lumbricales as similar to that of the interossei. Finally, the effects of ulnar paralysis may be manifested in the movements of the thumb, since it supplies two muscles which control it. This will be most apparent when you instruct the patient to press the thumb forcibly against the metacarpal bone of the index finger, or to adduct the thumb, since both of these motions will be rendered difficult or impossible.

These disturbances of motility create serious disturbances in those common functions in which the hand is of the most service. Writing, drawing, the playing of musical instruments, etc., are rendered difficult. The muscles which are supplied by the median and radial nerves are still able, however, to direct the hand and fingers in many acts which contribute to the comfort of the patient. In those cases where the muscles of the thenar eminence (supplied chiefly by the median nerve) are simultaneously affected, the use of the hand is almost entirely abolished.

#### THE SUBSCAPULAR NERVES.

These three nerves are given off by the *posterior cord* of the brachial plexus. They are called the upper, long, and lower subscapular nerves by some authors, while the numerical prefixes of first, second, and third are applied to them by

others. As will be seen by the table of the branches of the posterior cord of the brachial plexus,<sup>1</sup> the first or upper nerve supplies the subscapular muscle, the second or long nerve supplies the latissimus dorsi, and the third or lower nerve supplies the teres major, whose point of insertion is similar to that of the preceding muscle, since the tendons of the two often merge into each other.

Now, these three muscles are agents in creating certain movements at the shoulder joint ; hence it is to be presumed that each subscapular nerve sends a filament to that articulation. I am aware that the text-books usually give the credit of nerve supply to this joint to other sources, since the filaments of the supra-scapular and circumflex nerves can be traced easily to this articulation on account of their large size, but I am not inclined to believe that an axiom<sup>2</sup> of nerve supply, so fully sustained in other regions, will not fail to be supported by careful dissections of this part. The muscles supplied by the subscapular nerves are as important agents in the movements of the arm at the shoulder as those supplied from the trunks of the circumflex and the supra-scapular nerves ; and, if it be true that a joint, when exhausted or inflamed, can control the muscles which move it by means of a common nerve supply, the subscapular nerves must certainly be enumerated as one of the sources of supply to the shoulder joint.

#### CLINICAL POINTS PERTAINING TO THE SUBSCAPULAR NERVES.

These nerves are seldom the seat of a localized neuralgia, or of paralysis, except in connection with some other nerves of the upper extremity. The situation at which they are given off from the brachial plexus (being branches of the posterior cord and imbedded in the axillary space) is a safeguard against all common forms of external violence, while few tumors would create pressure upon these trunks without affecting other nerves at the same time, and possibly to an equal or greater degree.

<sup>1</sup> See page 384 of this volume.

<sup>2</sup> See page 359 of this volume.

Should the subscapular nerves happen to become impaired, the paralysis would be shown in those movements of the arm which are performed chiefly by the three muscles supplied by them. The latissimus dorsi could no longer bring the hand into the position assumed when scratching the anal region (in which movement it is prominently concerned), while the movement of *internal rotation* at the shoulder joint would be impaired, on account of the paralysis of the subscapularis and the teres major, as well as that of the muscle previously mentioned.

Should these nerves be the seat of degeneration, as in the case of progressive muscular atrophy, an alteration in the size of the latissimus dorsi and teres major muscles would be detected, and the other symptoms characteristic of this condition might be discovered, to a greater or less degree, depending upon the extent of the muscular changes.

#### THE CIRCUMFLEX NERVE.

This nerve arises from the posterior cord of the brachial plexus, usually in common with the musculo-spiral nerve, but sometimes by an independent communication with the posterior cord. It passes downward and outward behind the axillary artery and upon the subscapularis muscle, then backward (in company with the circumflex vessels) through a quadrilateral space bounded by the humerus, the teres major and minor muscles, and the long head of the triceps,<sup>1</sup> when it divides into its superior and inferior branch. It gives off a distinct branch to the shoulder joint, before its two terminal branches are formed, in the vicinity of the quadrilateral space, whose boundaries have been given.

The superior branch of the circumflex nerve is the larger of the two terminal filaments. It winds around the neck of the humerus, and supplies the deltoid muscle and the integument over the lower portion of the shoulder.

The inferior branch is small in comparison with the superior, and is distributed to the teres minor muscle and the

<sup>1</sup> This space can be found depicted in all the standard text-books upon anatomy.

integument over the back part of the shoulder. The twig, given off to supply the teres minor muscle, is sometimes furnished with a ganglionic enlargement.

CLINICAL POINTS PERTAINING TO THE CIRCUMFLEX NERVE.

From what has been said regarding the distribution of this nerve, it will be readily understood that the deltoid and teres minor muscles, as well as the integument of the shoulder and

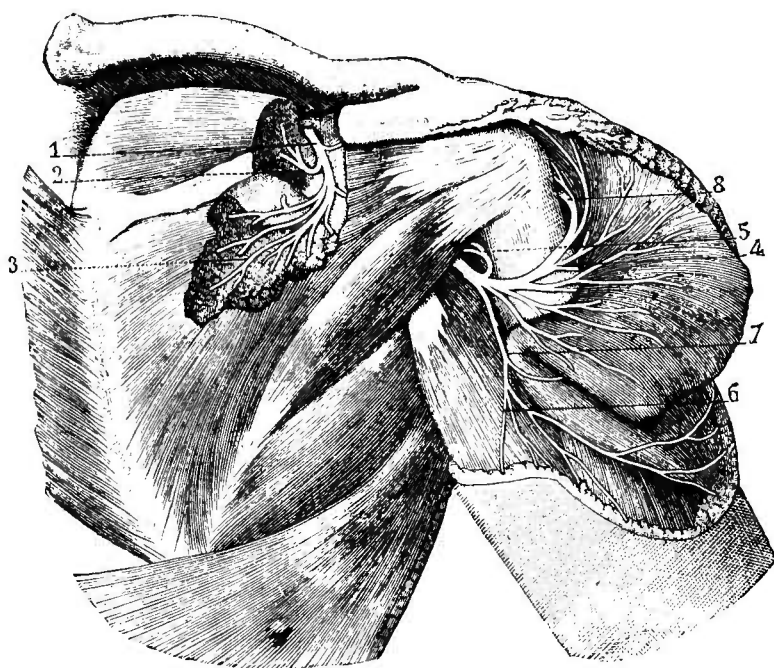

FIG. 150.—*Circumflex and subscapular nerves.* (Sappey.)

- 1, terminal extremity of the supra-scapular nerve ; 2, branch which this nerve furnishes to the supra-spinatus muscle ; 3, ramifications by which it terminates in that muscle ; 4, circumflex nerve embracing the surgical neck of the humerus ; 5, filament which this nerve sends to the teres minor muscle ; 6, cutaneous nerve to the shoulder ; 7, branches of the circumflex nerve given off to the deltoid muscle.

upper arm, will be affected by any impairment of the circumflex nerve. A fact previously mentioned, however, should not be lost sight of, viz., that the deltoid muscle, in its anterior portion, is supplied by the anterior thoracic nerves ; hence the impairment of the circumflex may not utterly paralyze it.

The intimate relations which this nerve bears to the shoulder joint and the course which it takes around the neck of the humerus render it particularly liable to injury from contusions, concussions, blows, or falls upon the shoul-

der; while dislocations of the humerus from the scapula, especially in a backward direction, are frequently followed by deltoid paralysis. If the shoulder joint become the seat of rheumatic, or any other type of chronic inflammation, the nerve may be involved in a neuritic process, and thus cause a paralysis of the deltoid or teres minor; while the same results may also follow "catching cold," a neuritis being probably established. Finally, this type of paralysis may follow injury to the brachial plexus, all the forms of central lesions, lead poisoning, and progressive muscular atrophy.

As paralysis of the teres minor muscle can not be easily detected, provided the infra-spinatus muscle remains unimpaired, the symptoms of circumflex paralysis are mostly confined to the inability to perform the various movements into which the deltoid muscle prominently enters. The arm can not be raised from contact with the wall of the thorax, by any attempt on the part of the patient, nor can it be brought forward and raised. When an attempt is made by the patient to raise the arm, the deltoid fibers do not contract, but lie flabby and loose, which distinguishes it from an ankylosed condition of the shoulder, without the necessity of communicated motion being resorted to in order to make the diagnosis. The deltoid region atrophies, and the shoulder joint becomes relaxed. A deep groove can often be detected through the atrophied muscle between the head of the humerus and the articular surface of the scapula.

#### THE MUSCULO-SPIRAL NERVE.

This is the largest branch of the brachial plexus. It arises from the posterior cord, usually in company with the circumflex nerve, and lies behind the third portion of the axillary artery, at its point of escape from the brachial plexus. It subsequently passes behind the upper part of the brachial artery, crosses the tendons of the teres major and latissimus dorsi muscles, accompanies the superior profunda artery in a spiral groove upon the humerus, and, by passing between the supinator longus and the brachialis anticus muscles, it reaches

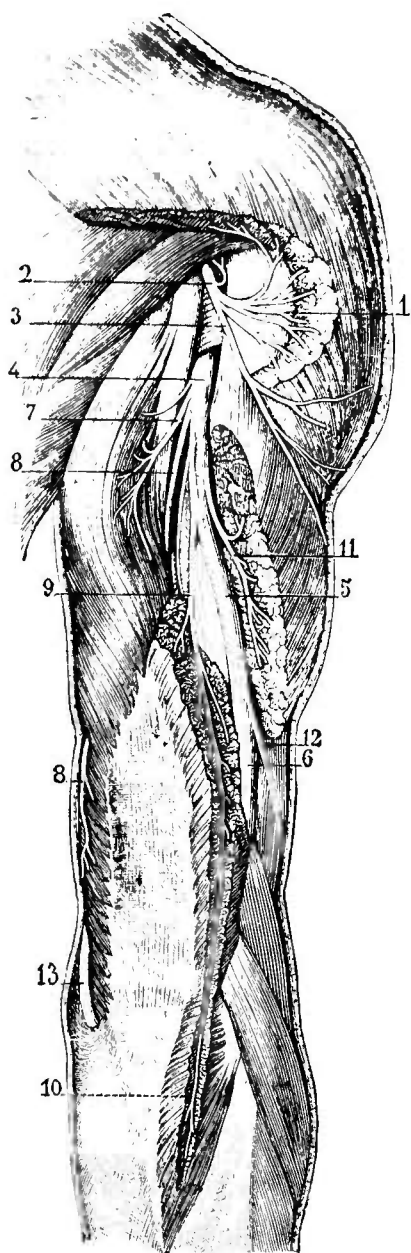

FIG. 151.—*Musculo-spiral nerve.*  
(Sappey.)



FIG. 152.—*Terminal branches of the musculo-spiral nerve.* (Sappey.)

FIG. 151.—1, circumflex nerve; 2, filament to the teres minor muscle; 3, cutaneous branch of the circumflex; 4, trunk of the musculo-spiral; 5, portion of this nerve which corresponds to the spinal groove of the humerus; 6, this same nerve passing between the brachialis anticus and supinator longus muscles; 7, branch which the musculo-spiral furnishes to the long head of the triceps muscle; 8, 8, branch to the internal portion of this muscle; 9, branch to the external portion of this muscle; 10, terminal branch of this same nerve distributed to the anconeus muscle; 11, another branch of the same nerve supplying also the external portion of the triceps muscle; 12, external cutaneous branch of the musculo-spiral.

FIG. 152.—1, trunk of the musculo-spiral nerve; 2, branch to the supinator longus muscle; 3, branch to the extensor carpi radialis longior; 4, branch to the extensor carpi radialis brevior; 5, bifurcation of this trunk; 6, its posterior or muscular branch; 7, the same branch crossing the supinator brevis, to which it gives off several small branches; 8, its terminal divisions; 9, anterior or cutaneous branch of this nerve; 10, terminal divisions of this branch; 11, musculo-cutaneous nerve; 12, 12, 12, its terminal divisions; 13, one of these branches which descends as far as the wrist, and then anastomoses with the cutaneous branch of the radial.

the external condyle of the humerus, where it divides into two terminal branches, viz., the *radial* and the *posterior interosseous nerves*.

The table of the branches given off from the posterior cord of the brachial plexus,<sup>1</sup> and the filaments of distribution of each, will help you in following the chief points of interest associated with this nerve. It will be perceived that the main trunk of the nerve supplies five muscles, while the posterior interosseous branch supplies all the remaining muscles upon the posterior surface of the forearm. This nerve is, therefore, essentially an extensor nerve, although the brachialis anticus and supinator longus muscles assist in flexion of the forearm. When we come to the consideration of the effects of paralysis of this nerve, the special symptoms will help still further to impress upon you the distribution of its branches to muscles as well as to the integument; and the points of interest, which depend upon the peculiar course of the main trunk of the nerve, will be made prominent, as an explanation of the frequent occurrence of this special type of paralysis in certain occupations.

The *radial branch* is exclusively distributed to the integument, as is shown in the table,<sup>2</sup> and the special distribution of the branches given off by this nerve to the integument of the hand has been already discussed at some length in a previous lecture.<sup>3</sup>

The musculo-spiral nerve gives an articular filament to the wrist joint, by means of its posterior interosseous branch; and, probably, some filaments also to the elbow joint, if we accept the general law of nerve distribution given by Hilton, so often quoted in the preceding lectures of this course.

We are now prepared to examine, with advantage, the diagrammatic plates,<sup>4</sup> in which the regions supplied by the different nerves of the upper extremity are exhibited more clearly than a verbal description could alone afford. They

<sup>1</sup> See page 384 of this volume.

<sup>2</sup> See page 384 of this volume.

<sup>3</sup> See page 402 of this volume.

<sup>4</sup> See cuts on pages 396 and 411 of this volume.



will prove of great assistance in studying the tables<sup>1</sup> in which the branches of the individual nerves are classified.

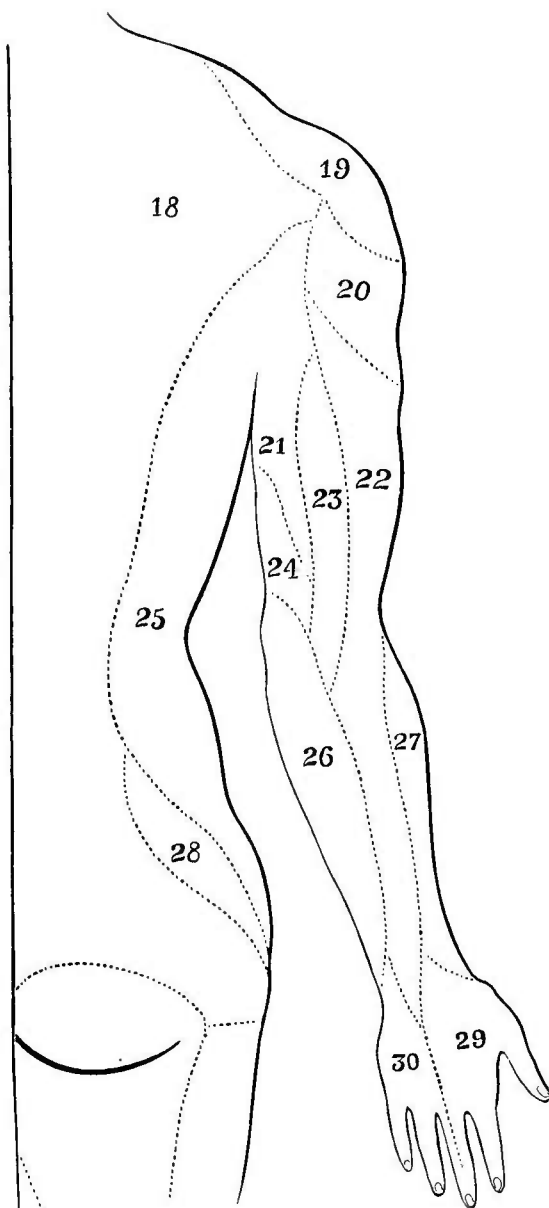

FIG. 153.—A diagram of the regions of cutaneous nerve distribution on the posterior surface of the upper extremity and trunk.

18, region supplied by the *second dorsal* nerve; 19, region supplied by the *supra-scapular* nerve; 20, region supplied by the *circumflex* nerve; 21, region supplied by the *intercosto-humeral* nerve; 22, region supplied by the *external cutaneous* nerve; 23, region supplied by the *internal cutaneous branch* of the *musculo-spiral* nerve; 24, region supplied by the "*nerve of Wrisberg*;" 25, region supplied by the *lateral branches* of the *intercostal* nerves; 26, region supplied by the *internal cutaneous* nerve; 27, region supplied by the *musculo-cutaneous* nerve; 28, region supplied by the *iliac branch* of the *ilio-inguinal* nerve; 29, region supplied by the *radial* nerve; 30, region supplied by the *ulnar* nerve.

This diagram limits the distribution of each nerve with more positiveness than can be well verified, since the cuta-

<sup>1</sup> See tables on pages 383, 384, and 385 of this volume.

neous filaments of two nerves may supply the *borders* of any of these regions, as the nerves tend to overlap each other. It is not well, therefore, to rely positively upon the border limits of any region in your endeavors to detect anæsthesia, should you suspect a paralytic condition of any special nerve, and seek this means of confirming your diagnosis.

The rule of Hilton would naturally cause us to expect that the muscles supplied by any special nerve would act as a guide in determining the source of the cutaneous nerve supply over the points of attachments of those muscles; and we are not disappointed when we examine closely the area of cutaneous distribution of the musculo-spiral nerve. This nerve supplies the supinators of the hand, the extensor muscles of the elbow joint and of the wrist joint, and the extensor muscles of the fingers and the thumb; hence we find the skin over these groups of muscles supplied, to a great extent, by the same nerve which affords motor power to the muscles underneath. This fact will thus help you to remember the area of distribution of any nerve to the skin by a process of reasoning based upon the muscles which are supplied by the same nerve, and the numerous examples, already quoted in confirmation of this general law, prove that the deduction drawn from it is, in all cases, approximately accurate.

#### CLINICAL POINTS PERTAINING TO THE MUSCULO-SPIRAL NERVE.

The musculo-spiral nerve is more frequently affected with paralysis than any of the nerves of the upper extremity. It is particularly liable to both peripheral and central causes of paralysis; thus, in cerebral hemiplegia, the muscles supplied by this nerve are, perhaps, more commonly affected than those supplied by any other nerve, while paralysis of these muscles is common as the result of chilling of the upper extremity, traumatism, and lead poisoning.

The anatomical situation of the musculo-spiral nerve and the peculiarity of its course around the humerus probably explain the frequent occurrence of paralysis, since it may be easily compressed by sleeping upon the arm. It is common

to meet with this type of paralysis in patients who have used their arm as a pillow, or in drunkards who have slept in some constrained position upon benches, steps, etc. Persons who have fallen exhausted and have rested upon the arm, and soldiers who have slept upon the damp ground, often arise with this form of paralysis. It is stated by Brenner<sup>1</sup> that the coachmen of Russia, who are in the habit of sleeping upon the box with the reins wound around the upper arm, are victims to this condition; and Bachon<sup>2</sup> reports the same result as common among the water-carriers of Rennes, since they pass their arm through the handle of the heavy water-pails to more securely compress them against the chest. The habit of the Russians of tightly bandaging the arms of infants to the body, and allowing them to sleep upon one side for long intervals, seems to promote the frequent occurrence of this trouble.

Among the other forms of traumatism which conduce toward this form of paralysis may be mentioned the use of poorly padded crutches, the kicks of animals, cuts, stab wounds, fractures of the humerus, dislocation of the humerus at the shoulder joint, and the development of an excessive amount of callus after a fracture.

Rheumatic affections and a neuritis of the musculo-spiral nerve are reported as causes by Bernhardt and others; and cases of hysterical origin have been rarely but positively authenticated.

Finally, lead poisoning must be mentioned as one of the most common causes of paralysis of the muscles supplied by the musculo-spiral nerve. The existence of this form of poisoning will have generally been indicated, previous to the appearance of paralysis, by colic, jaundice, and arthralgia, as the muscles are seldom affected until the latter stages. The extensor communis digitorum muscle is usually affected first, and the paralysis gradually extends to the other muscles supplied by the musculo-spiral nerve. The muscles of the arm are much less frequently affected than those of the hand and forearm; but, in severe cases, the muscles of the upper arm,

<sup>1</sup> As quoted by Erb.

<sup>2</sup> As quoted by Erb.

shoulder, and even those of the lower extremity, may become involved.

It is difficult as yet to explain the apparent predisposition of lead poisoning to affect the muscles of the musculo-spiral region in preference to the flexor muscles. Gombault, Bernhard, Westphal, Bärwinkel, Hitzig, and Lancéreaux have given special attention to the subject, and arrived at no common ground upon which they can all agree. The condition has been explained as the result of a venous stasis (Hitzig), and as the result of arterial ischæmia (Bärwinkel); both of whom regard these conditions as favoring the deposition of lead in the muscles of the extensor region of the forearm. Peripheral nerve degeneration has been claimed as the explanation of the paralytic symptoms by Gombault, Westphal, and Lancéreaux, and in this view the investigations of Neuman, Erb, and Eichhorst coincide. Whether a spinal origin will be yet determined which will explain the muscular changes and the loss of power, is yet to be decided by further pathological research.

The symptoms which characterize this type of paralysis have such a distinctive form as to be easily recognizable by the physician at the very first glance. A reference to the table which shows the distribution of the musculo-spiral nerve to muscles<sup>1</sup> will help to explain them. We see that this nerve sends filaments to the triceps and brachialis anticus muscles in the arm, and to all the extensor muscles of the forearm. In accordance with this distribution, the hand is kept in a state of flexion when this nerve is paralyzed, and can not be raised or extended; the thumb is flexed and adducted; and the fingers are flexed and cover the thumb. When the patient attempts to extend the fingers, the interossei and lumbricales muscles alone can be made to act, and these muscles, as has been mentioned before, can only extend the two terminal phalanges while they flex the basal phalanx.<sup>2</sup>

<sup>1</sup> See page 384 of this volume.

<sup>2</sup> The explanation of this fact lies in the insertion of the tendons of these muscles into the tendons of the common extensor of the fingers.

The thumb and the index finger can not be extended or abducted; the patient can not supinate the hand when the forearm is extended (this position being assumed in order to exclude the action of the biceps muscle), nor can the forearm be half bent and the hand half supinated by the supinator longus muscle; and, finally, when the patient is instructed to flex the forearm, when placed in a position of half flexion and semi-prostration, the supinator longus muscle lies flaccid, and does not become tense and hard as in health. The loss of power in the triceps muscle renders it impossible for the patient to extend the forearm

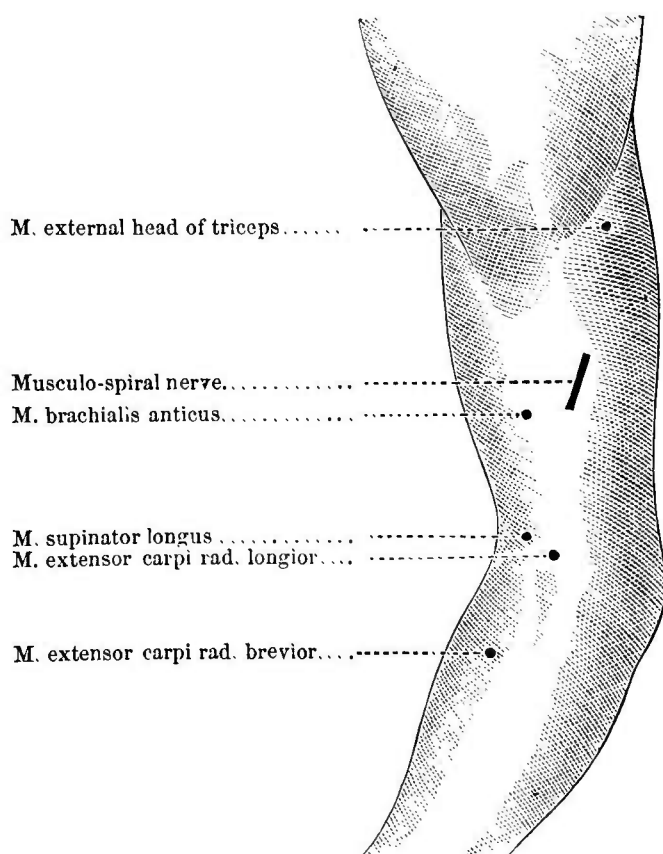

FIG. 154.—*The motor points on the outer aspect of the arm.*

upon the arm when the arm is first raised above the head; nor can the forearm be extended with the same degree of force as the healthy side in any position of the arm. When the hand is laid upon the table, the patient is unable to raise the hand from contact with it, but the lateral movements of the fingers can be performed as in health,

since these movements are controlled by the interossei muscles. The action of the flexor muscles of the wrist seems feeble, since the antagonistic action of the extensors does not afford a fixed point of action; but, if the wrist be forcibly extended and fixed, it will be seen that the wrist flexors are not paralyzed.

This form of paralysis interferes with almost all of the numerous employments of daily life, since the functions of the hand are most seriously impaired. The patient can not well hold or grasp anything, on account of the inability to perform

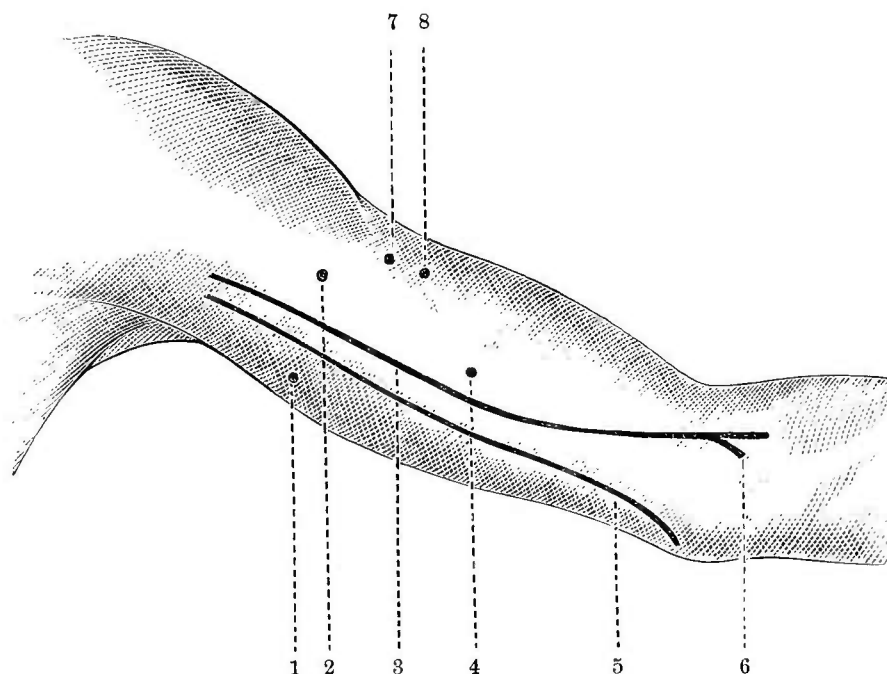

FIG. 155.—*The motor points on the inner side of the arm.*

1, m. internal head of triceps; 2, musculospiral nerve; 3, median nerve; 4, m. coraco-brachialis; 5, ulnar nerve; 6, branch of median nerve for pronator radii teres; 7, musculospiral nerve; 8, m. biceps flexor cubiti.

the extension of the thumb or fingers; and the impairment of the supinators still further adds to the uselessness of the hand. The regions of the integument supplied by the musculospiral nerve exhibit more or less anæsthesia, although the extent of this symptom, like that of the muscular paralysis, is modified by the height of the lesion, which affects the nerve as well as by its character. In some cases, extensive motor paralysis may be present without any marked

disturbance of sensibility; this can only be explained by the presence of anastomosis between the cutaneous nerves

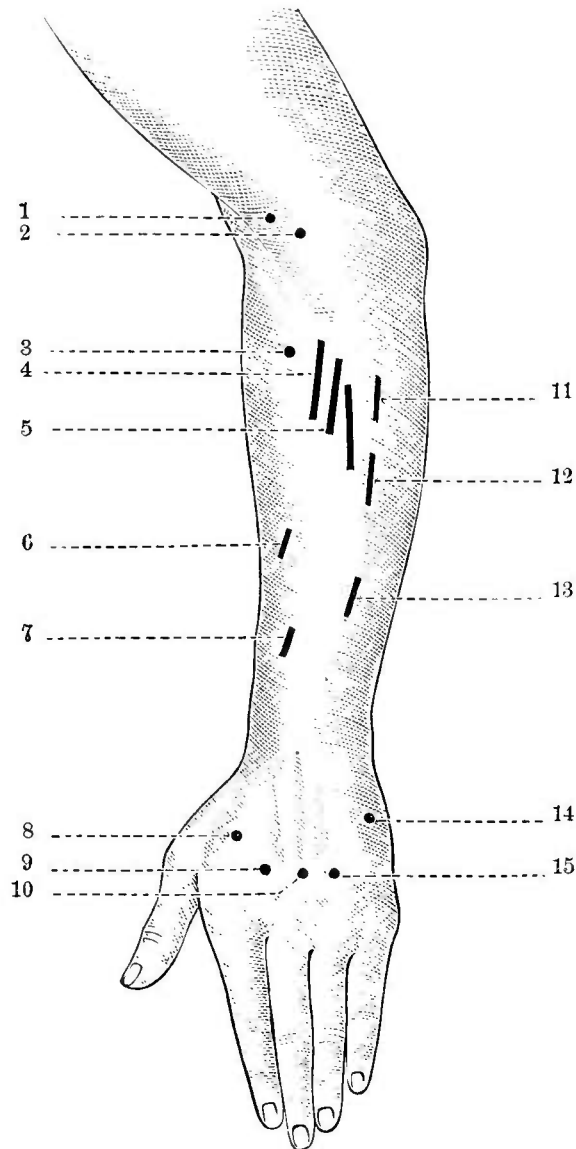

FIG. 156.—*The motor points on the extensor (posterior) aspect of the forearm.*

1, m. supinator longus; 2, m. extensor carpi rad. longior; 3, m. extensor carpi rad. brevior; 4, 5, m. extensor communis digitorum; 6, m. extensor ossis. met. pol.; 7, m. extensor primi. internod. pol.; 8, m. first dorsal interosseous; 9, m. second dorsal interosseous; 10, m. third dorsal interosseous; 11, m. extensor carpi ulnaris; 12, m. extensor min. digiti; 13, m. extensor secund. internod. pol.; 14, m. abduct. min. digiti; 15, m. fourth dorsal interosseous.

of different origins, as was demonstrated by Tripier and Arloing<sup>1</sup> upon dogs.

In the diagnosis of this type of paralysis, it is often difficult to determine the exact nature and seat of the exciting

<sup>1</sup> As quoted by Erb.

cause. The most common causes are injury, pressure, and lead poisoning; but the existence of exciting neuritis, some

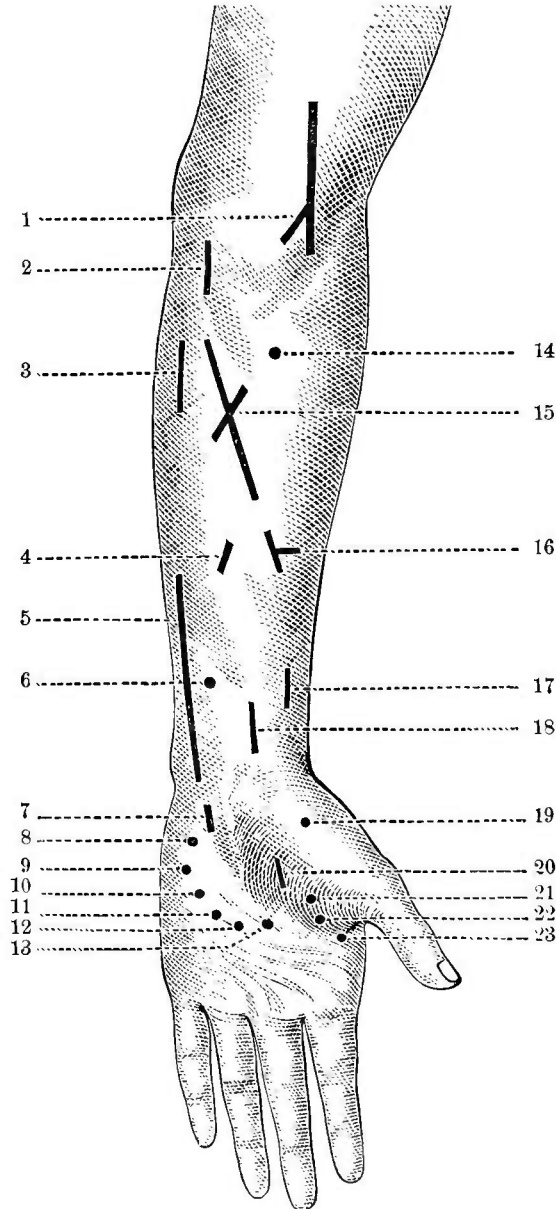

FIG. 157.—*The motor points on the flexor (anterior) aspect of the forearm.*

1, median nerve and branch to m. pronator radii teres; 2, m. palmaris longus; 3, m. flexor carpi ulnaris; 4, m. flexor sublim. digit.; 5, ulnar nerve; 6, m. flex. sublim. dig.; 7, volar branch of the ulnar nerve; 8, m. palmaris brevis; 9, m. abductor min. digit.; 10, m. flexor min. digit.; 11, m. opponens min. digit.; 12, 13, m. lumbricales; 14, m. flexor carpi radialis; 15, m. flexor profund. digitorum; 16, m. flexor sublim. digitorum; 17, m. flex. longus pollicis; 18, median nerve; 19, m. opponens pollicis; 20, m. abductor pollicis; 21, m. flexor brevis pollicis; 22, m. adductor pollicis; 23, m. first lumbricalis.

cerebral disease, or an hysterical cause, must be excluded or determined by the concomitant symptoms. When the paral-



ysis is due to local compression, the triceps muscle is not usually affected, and the same statement applies to the rheumatic form, while in both of these types the disturbance of sensibility is most frequently confined to the hand alone. In lead paralysis, the supinator brevis muscle remains unaffected until late in the disease, and the supinator longus muscle is rarely involved, even in severe forms of poisoning. While this can not be taken as an absolute sign, it is a most valuable point in diagnosis, and should be always remembered. In addition to the muscular paralysis, lead poisoning is often accompanied by muscular atrophy and swelling of the veins upon the extensor side of the forearm; while tendinous swellings are frequently detected in the region of the wrist.

The duration of paralysis of the musculo-spiral nerve depends largely upon the exciting cause. Lead poisoning produces, in all cases, an exceedingly slow and obstinate form of trouble, and the paralysis may be incurable; "crutch paralysis" usually recovers speedily, if the pressure be discontinued; traumatic paralysis, if the injury be severe, follows a protracted course; while those cases which depend upon cerebral origin are modified, as to their course and termination, by the character of the exciting lesion.

#### THE DORSAL NERVES.

The nerves of the dorsal region are twelve in number upon each side of the trunk. They escape from the vertebral canal by means of foramina between the dorsal vertebræ, and are connected to corresponding ganglia of the sympathetic nerve. Each dorsal nerve is joined to a ganglion of the sympathetic, immediately after its escape from the foramen between the vertebræ, by two small and short filaments; hence, there are frequent points of communication between the cerebro-spinal and sympathetic systems of nerves throughout the length of the vertebral column. As has been stated in a previous lecture, the first dorsal nerve assists to form the brachial plexus,

and can therefore be properly classed as one of the nerves of the upper extremity rather than a nerve of the trunk; the remaining nerves of this region are distributed entirely to the parietes of the thorax, the adjacent pleura, and the integument covering the front, sides, and back of the chest, and the upper part of the abdomen.

The table which I now show you is designed to make the general distribution of the dorsal nerves easy of comprehension, and to assist in reviewing the chief points of interest which are presented in connection with the nerves of this region.

NERVES OF THE DORSAL REGION.

DORSAL NERVES. {	POSTERIOR DIVISIONS. {	External branches. {	In upper six nerves.	{	Filaments to transversalis colli, Filaments to longissimus dorsi, Filaments to trachelo-mastoid, Filaments to levatores costarum, Filaments to sacro-lumbalis, Filaments to accessorius.
			In the lower six nerves.	{	Same muscles as in preceding bracket, <i>Integument</i> of the back.
			In upper six nerves.	{	Filaments to semispinalis dorsi, Filaments to multifidus spinæ, <i>Integument</i> of back.
		Internal branches. {	In the lower six nerves.	{	Same muscles as in preceding bracket, No cutaneous filaments.
			Muscular branches.	{	Intercostals, Triangularis sterni.
			Lateral cutaneous.	{	<i>Integument</i> of chest and mammæ, Upper part of external oblique muscle, <i>Integument</i> over upper part of latissimus dorsi and the scapular region.
	ANTERIOR DIVISIONS. {	Six upper or thoracic intercostals. {	Anterior cutaneous.	{	<i>Integument</i> of mammæ and side of the chest.
			Muscular branches.	{	Intercostals, Abdominal muscles.
		Six lower or thoracico-abdominal intercostals. {	Lateral cutaneous.	{	<i>Integument</i> of abdomen, as far as the edge of rectus, <i>Integument</i> over lower part of latissimus dorsi.
			Anterior cutaneous.	{	Upper part of rectus and <i>integument</i> in front part of abdomen.

It will be perceived that these nerves, like those of the cervical region, divide into anterior and posterior branches, in the immediate vicinity of the vertebral column. The posterior divisions supply the muscles of the back and the in-

tegument which covers that region, while the anterior divisions supply the muscles of respiration and some of the

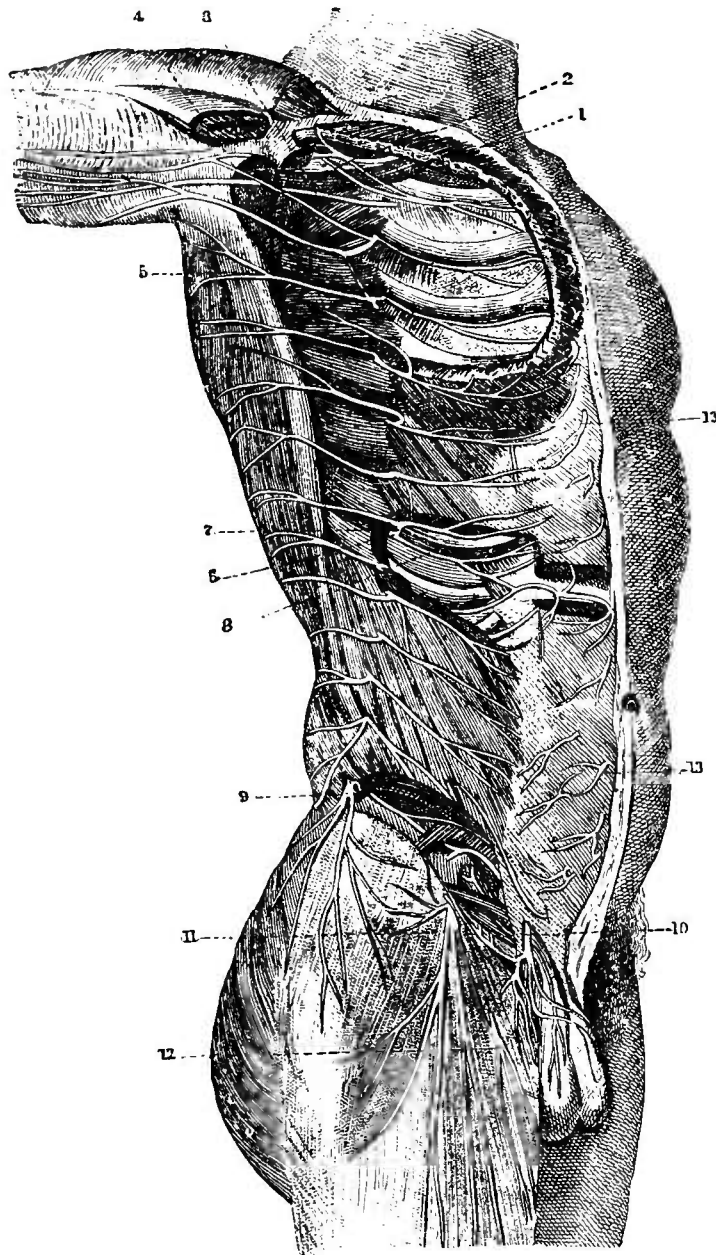

FIG. 153.—*The intercostal nerves.* (Masse.)

The pectoralis major and minor muscles are removed. The obliquus externus and rectus abdominis are divided, and removed in some places.

1, axillary vein: the artery is removed; 2, portion of the brachial plexus and two thoracic branches; 3, brachial twig of the first intercostal nerve; 4, brachial twig of the second intercostal nerve; 5, inosculation between two branches; 6, division of an intercostal branch into 7, a superficial branch, and 8, a deep branch; 9, gluteal branch of the twelfth intercostal nerve; 10, termination of the ilio-serotal branch of the lumbar plexus; 11, inguino-cutaneous branch; 12, twig of the genito-crural branch; 13, 13, portions of the deep nerves after they have become superficial.

abdominal muscles, and the integument of the chest, loins, and abdomen. The intercostal nerves are formed entirely

from the anterior divisions; those arising from the upper half of the dorsal region being called the "thoracic" intercostals, while the lower six nerves are called the "thoracico-abdominal" intercostal nerves.

The first and last dorsal nerves are somewhat peculiar in their distribution, and deserve a special description. The first dorsal nerve has no lateral cutaneous branch, since the branch which corresponds to the lateral cutaneous branch of the other nerves is of large size, and enters into the formation of the brachial plexus. The continuation of this nerve along the first intercostal space is of small size, and ends in the anterior cutaneous nerve.

The last dorsal nerve is the largest of the twelve, and is usually connected with the first lumbar nerve by a filament called the "dorso-lumbar" nerve, which descends in the substance of the quadratus lumborum muscle. It communicates also with the hypogastric branch of the ilio-hypogastric nerve (a branch of the lumbar plexus), between the internal oblique and transversalis muscles of the abdomen. Its lateral cutaneous branch is very large, and is distributed to the integument of the front part of the gluteal region.

The distribution of the dorsal nerves to the *costal layer of the pleura* is not specially designated in the table,<sup>1</sup> but it is a fact of great physiological interest. Hilton draws an analogy between the pleura and a synovial membrane of a joint; and the intercostal muscles are also compared by him to those moving a joint. Thus this author adduces further proof of his general law of nerve distribution, since the skin of the chest, the intercostal muscles, and pleura are supplied from the same source. In pursuing this same line of reasoning (and the analogy is not a strained one from a physiological standpoint), the abdominal muscles might also be included among the list of muscles which move the ribs; and the nerve supply to them also would thereby be explained by this same axiom, viz., that the nerves which supply a joint supply the

<sup>1</sup> See page 420 of this volume.

muscles which move it and the skin over the insertions of those muscles.

It should be recollected that some of the filaments derived

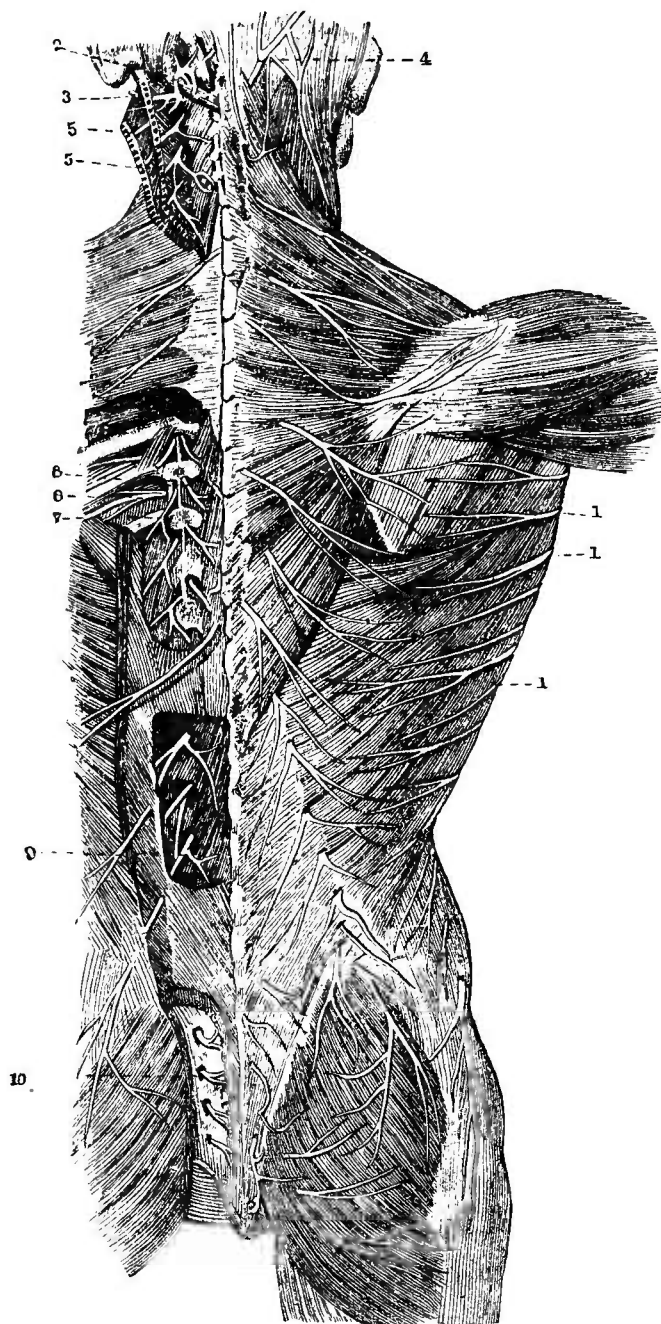

FIG. 159.—*The nerves situated on the posterior part of the trunk.* (Masse.)

Portions of the trapezius, splenius, complexus, trachelo-mastoideus, latissimus dorsi, and gluteus maximus muscles, etc., etc., are removed.

- 1, 1, 1, posterior twigs of the superficial branches of the intercostal nerves; 2, posterior branch of the first cervical nerve, or sub-occipital; 3, posterior branch of the second cervical nerve; 4, inosculation of this branch with the great mastoid branch; 5, 5, posterior branches of two cervical nerves; 6, intercostal branch; 7, external twig of a dorsal branch; 8, internal twig of a dorsal branch; 9, posterior branch of a lumbar nerve; 10, posterior branch of a sacral nerve.

from the upper intercostal nerves *cross the axillary space* and supply the integument of the arm. The "nerve of Wrisberg," which has been described in connection with the cutaneous nerves of the arm, is perhaps the most important of these branches. It may thus be understood why the pain of pleuritic inflammation may be carried to and felt in the region of the axilla and inner arm, and why distinct points of tenderness to pressure may sometimes be detected in these regions when the disease is confined to the trunk.

#### CLINICAL POINTS PERTAINING TO THE DORSAL NERVES.

From the suggestions thrown out as to the physiological importance of nerve distribution, and from the fact that the pleura is supplied from the same nerve sources as the respiratory muscles and the integument of the chest, abdomen, and inner arm, some important clinical lessons may be drawn. Patients suffering from pleurisy feel a pain in the costal muscles which compels restricted movement of the ribs, and which limits the respiratory function largely to the diaphragm. Now, these painful cramps and stitches are independent of the pain arising alone from the inflamed pleural surface, and the diminution of the respiratory movements is due to a partially contracted state of the muscles of the chest, as is demonstrated by the fact that patients can not draw a long breath if asked to do so; hence, we may reasonably conclude that Nature has so distributed the nerves to the pleura as to enable that serous membrane to control the muscles which create movement of the adjacent costal surfaces, and thus insure its quietude during the stages of inflammation or repair. It is wisely suggested by Hilton, in this connection, that we learn a lesson in the treatment of such cases from Nature herself, viz., "never to allow a patient, suffering from pleurisy or pneumonia, to talk except in monosyllables, so as to avoid a full inspiration."

The diagnostic value of pain is well exemplified in the region of the thorax. Persistent pains *high up between the shoulders* are strongly indicative of diseases of the heart,

aneurism of the arch of the aorta, stricture of the œsophagus, and anything which would tend to create pressure within the

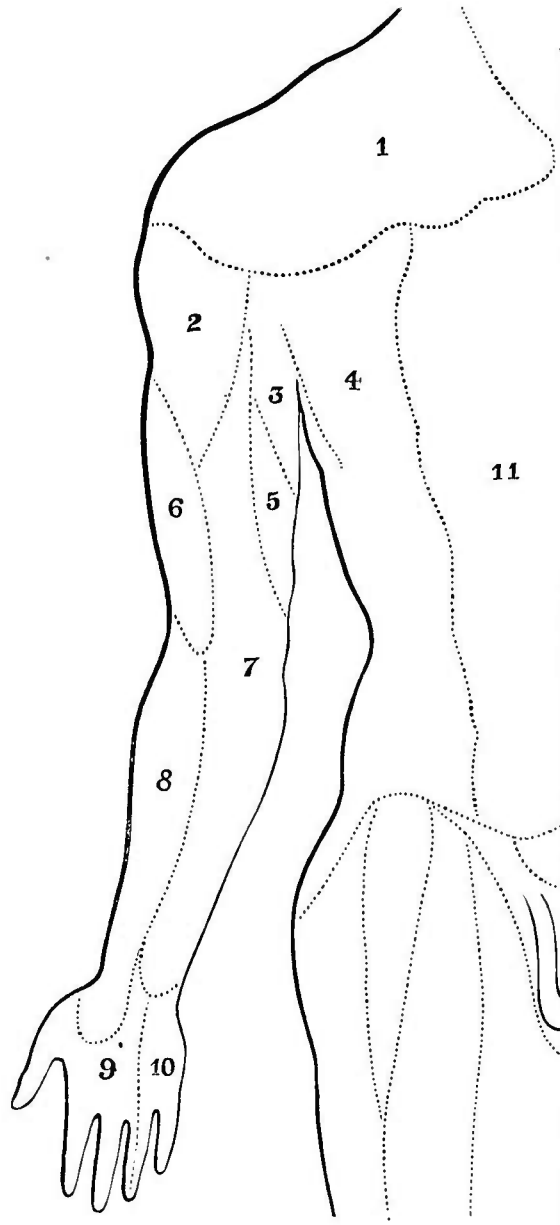

FIG. 160.—A diagram of the regions of cutaneous nerve distribution in the anterior surface of the upper extremity and trunk. (Modified from Flower.)

- 1, region supplied by the supra-clavicular nerve (branch of the cervical plexus); 2, region supplied by the circumflex nerve; 3, region supplied by the intercosto-humeral nerve; 4, region supplied by the intercostal nerve (lateral branch); 5, region supplied by the lesser internal cutaneous nerve (nerve of Wrisberg); 6, region supplied by the musculospiral nerve (external cutaneous branch); 7, region supplied by the internal cutaneous nerve; 8, region supplied by the musculocutaneous nerve; 9, region supplied by the median nerve; 10, region supplied by the ulnar nerve; 11, region supplied by the intercostal nerve (anterior branch).

posterior mediastinum.<sup>1</sup> If we meet with persistent pain in the space lying between the middle of the scapula and the

<sup>1</sup> John Hilton, *op. cit.*

*lumbar region of the spine*, we may have good ground to suspect the existence of some disease of the abdominal digestive viscera, the pain being carried to the surface probably by means of the splanchnic nerves.<sup>1</sup> It is not uncommon for disease confined to the transverse colon to manifest itself in the form of persistent pain in the lower intercostal region.

The frequent occurrence of cancer in the mammary region renders its detection one of importance in its early stages, while, in the later stages, the pleura and the glands of the axilla and mediastinæ may be secondarily affected with cancer tubercles. Now, in these conditions, the presence of pain in the back, between the shoulders, in the side of the chest, or down the inner side of the arm, may possibly afford invaluable aid in diagnosis.

The distribution of the *sixth* and *seventh intercostal nerves* to the skin over the *pit of the stomach* may be a useful fact to remember in making a diagnosis of the cause of pain in that region, since, by tracing the course of these two nerves from before backward, and observing the healthy or unhealthy condition of the structures near to which the nerves would pass—as the pleura, ribs, œsophagus, aorta, etc.—we may at last reach the spine as the seat of the disease which is producing pain in a region far remote from the cause to which it is really due. It is by no means uncommon for spinal affections of the mid-dorsal region to manifest themselves by a pain which is distressing, and referred to the pit of the stomach; and such an origin is rendered still more probable if present on both sides of the median line, since symmetrical pains are especially characteristic of central origin.<sup>2</sup> Should such a pain exist, and a marked relief ensue when the patient is in a recumbent posture, the probability of spinal origin is still more distinctly suggested.

<sup>1</sup> The great splanchnic nerve is connected above with the fourth, fifth, and sixth dorsal nerves, and below with the solar plexus and thence with the stomach, duodenum, liver, pancreas, and intestines. It seems probable, therefore, that the pain experienced in the region of the scapula, by patients afflicted with diseases of the digestive organs, is referable in some way to the greater splanchnic nerve. •

<sup>2</sup> The reader is referred to the general axioms of nerve distribution, quoted on pages 359, 360, and 361 of this volume.



It has been stated in previous lectures that pains which are confined to one side of the body are usually indicative of an exciting cause which is confined to the same side, rather than of diseased conditions of the central nerve ganglia. It is therefore customary, with those most familiar with the steps necessary to reach a scientific diagnosis, to search for some cause upon the same side of the body, in case a pain exists which is not symmetrically developed upon both sides. I have known the diagnosis of aneurism within the thorax to be discovered by a pain, which was one-sided, and which was the only symptom which the patient was conscious of, where the existence of the tumor would probably have gone on undetected but for this valuable guide. A constant pain in the back is one of the most positive signs of aneurism of the cœliac axis, and I question if the diagnosis of aneurism of the abdominal aorta in any part of its course should ever be made unless this symptom can be detected.

Pain in the region of the *pectoral muscle* may indicate some cause referred either to the *third* or *fourth cervical* or the *first dorsal nerves*; hence we must look in two different localities for the exciting lesion. The distribution of the cervical nerves to the fascia covering the anterior portion of the chest is not sufficiently well recognized by the profession at large, and doubtless many cases have been a source of anxiety to the physician which could have been easily explained, had this point been impressed upon them.

The distribution of the *lower intercostal nerves* to the integument covering the upper part of the *muscles of the abdomen* may be useful in diagnosis, since pain in this region of the abdomen may be created by pressure of fluid in the pleural cavities, and by other lesions situated above the line of the diaphragm. It is not improbable, therefore, that many cases of this character have misled the medical attendant who has referred the symptom of abdominal pain to organs within the cavity of the abdomen, when the exciting cause was to be sought for within the chest or in the course of the lower intercostal nerves? Certainly, successful treatment depends upon accu-

racy in diagnosis ; and the application of the laws of nerve distribution to fine discriminations in the appreciation of symptoms is a guide whose value and utility are not generally known.

When we have our attention called by a patient to a pain, no matter where its situation may chance to be, we are positive that it can be traced to the nerves supplying the part. Here, then, we have a direct guide to follow which will usually lead us, if we are anatomists, to the source of the pain. As an example of this, and they are too numerous to mention in detail, there is one symptom in spinal disease which stands out prominently, and I might say solicits our proper appreciation of it, and that is a fixed and local pain upon the surface of the body, with or without exacerbations, and often without any local increase of temperature at the seat of the disease. I feel quite certain that through the medium of this one symptom alone, if properly employed, morbid conditions of the vertebræ or the spinal cord, its membranes, and its nerves, may be often diagnosed long before any palpable deformity of attitude or gait exists, and a cure often effected by simple rest.

It is in connection with the nerves of the dorsal region that pain is a more valuable guide than in almost any other portion of the body. The subjacent viscera, occupying the thoracic and abdominal cavities, are constantly manifesting diseased conditions by pain of a superficial character (through the intimate communications which exist between the splanchnic and dorsal nerves) at spots often far removed from the exciting cause. It is natural that the medical attendant, unless his attention has been directed to this fact, should attribute the pain to some fanciful cause in the locality of that pain, or to some general diagnosis of neuralgia, malaria, etc., when an anatomical knowledge might direct him aright both in diagnosis and treatment. We know that liver disease may be occasionally manifested by a pain in the region of the right shoulder ; that gastric and intestinal disorders frequently produce a constant pain in the back between the scapulæ ; and that tumors of the viscera may produce like results by press-

ure upon the splanchnic nerves or the solar plexus of which they form a part. Without such a knowledge and its satis-

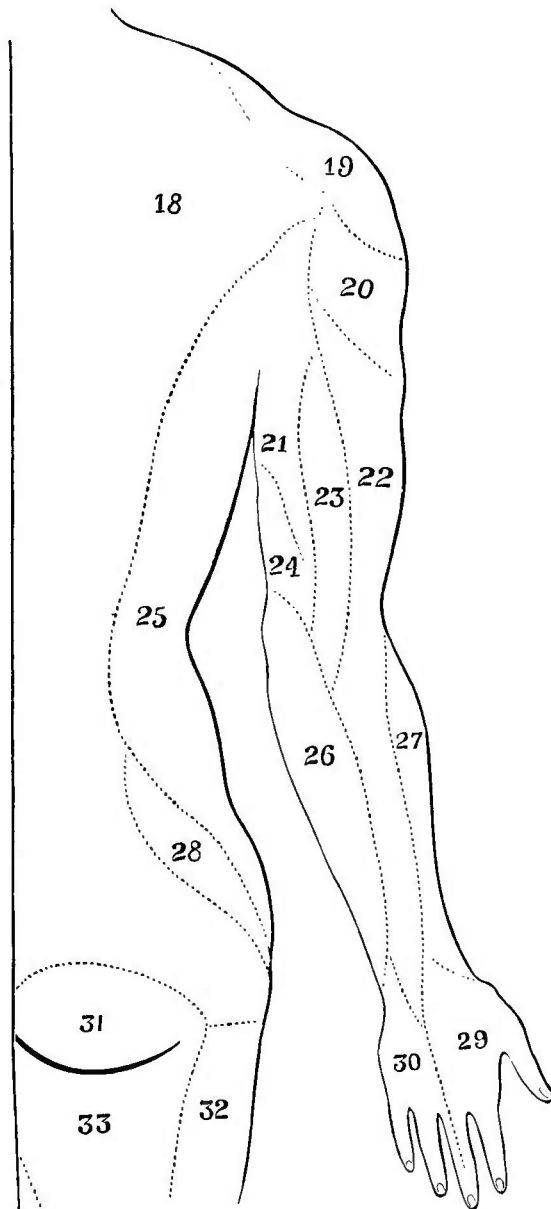

FIG. 161.—A diagram of the regions of cutaneous nerve distribution on the posterior surface of the upper extremity and trunk. (Modified from Flower.)

18, region supplied by the *second dorsal nerve*; 19, region supplied by the *supra-scapular nerve*; 20, region supplied by the *circumflex nerve*; 21, region supplied by the *intercosto-humeral nerve*; 22, region supplied by the *external cutaneous nerve*; 23, region supplied by the *internal cutaneous branch of the musculo-spiral nerve*; 24, region supplied by the "*nerve of Wrisberg*"; 25, region supplied by the *lateral branches of the intercostal nerves*; 26, region supplied by the *internal cutaneous nerve*; 27, region supplied by the *musculo-cutaneous nerve*; 28, region supplied by the *iliac branch of the ilio-inguinal nerve*; 29, region supplied by the *radial nerve*; 30, region supplied by the *ulnar nerve*.

factory explanation, would we be apt to refer such pain to causes so remote? Would we look for causes of abdominal

pain in the region of the thorax, without the knowledge that the lower intercostal nerves supplied the abdominal muscles? The lessons taught by anatomy are of a most practical character, and worthy of the study even of those old in the practice of physic. If a patient complains of pain on the surface of the body, it must be expressed by the nerve which resides there; there is no other structure that can express it, and somewhere in its course of distribution, between its peripheral filaments and its central point of origin from the encephalon or the spinal cord, the precise cause of this pain expressed upon the surface must be situated.

#### INTERCOSTAL NEURALGIA.

Those forms of neuralgia which have their seat in the nerves which arise from the dorsal region of the spinal cord are grouped under the term "dorso-intercostal" neuralgia. The exact seat of the pain varies not only with the special nerve affected, but also with the branch of the nerve which seems to manifest the most irritation. Thus, if the upper two nerves are involved, the pain may extend to the arm as well as the trunk; if the posterior branches of the dorsal nerves be alone involved, the pain will be perceived in the back and loins; and, finally, if the anterior branches be alone the seat of pain, it will be confined to the intercostal spaces and the anterior region of the chest. It is rare to find the anterior and posterior branches of any dorsal nerve simultaneously affected with neuralgia. The anterior branches are usually the ones which suffer, and the pain assumes a type which is properly called "intercostal."

Intercostal neuralgia is more common in women than in men, and chiefly affects weak, hysterical, and anæmic subjects. It appears often in those who are convalescing from some severe type of disease. The causes to which this form of neuralgia can be traced include exposure to cold or dampness, anatomical changes in the nerves themselves, diseases of some of the adjoining organs (especially in connection with phthisis), embarrassment to the venous return of the affected

region, dilatation of the venous plexuses of the interior of the vertebral canal, aortic aneurisms (which lead to absorption of the vertebræ or ribs), all possible diseases of the vertebræ themselves, and also of the ribs, diseases of the spinal cord, and malarial affections.

This form of neuralgia is most common upon the left side, and Henle has attributed this clinical fact to the arrangement of the intercostal veins of the left side,<sup>1</sup> which relatively tends to impede the return of blood upon the left in contrast to the right side. From the extensive list of causes which have been given—and many of the subdivisions of each have been omitted—it can be readily understood that, to make an accurate diagnosis as to the etiology of intercostal neuralgia, is never possible without a most thorough physical examination of the subjacent organs, the bones of the thorax, and the conditions of the soft tissues.

The symptoms of this disease are generally confined to the anterior and lateral walls of the trunk, more rarely to the back and the loins. The area of the pain indicates the nerves affected, which is often a point of great value in searching for the cause. While the pain is of a burning, dull, and persistent character for the greater part, yet it is often characterized by paroxysms of tearing and lancinating pains which follow the course of the nerves affected with a remarkable precision. The violence of these paroxysms may be very great, so as to cause syncope. All respiratory motions, such as sneezing, coughing, blowing the nose, etc., increase the pain, and the skin is sensitive to the slightest pressure, even the weight of the bedclothes distressing the patient, although firm pressure may sometimes afford relief. While the paroxysm is active, the patients sit with the body inclined toward the affected side, and their faces indicate the most extreme anxiety. They neither dare to speak loudly nor take a deep inspiration, on account of the pain induced by such efforts.

<sup>1</sup> The intercostal veins of the left side empty into the left superior intercostal vein or the left vena azygos; in either case, the blood takes a circuitous route to the superior vena cava.

In intercostal neuralgia, as in most other forms, there are certain points which are particularly sensitive to pressure, and are of great aid in confirming the diagnosis. These points comprise, first, one near to the vertebral column (*vertebral point*), where the nerve emerges from the inter-vertebral foramen; secondly, one at about the middle of the entire course of the nerve, corresponding to a line dropped from the center of the axillary space (*lateral point*), where the lateral branch emerges beneath the integument; and, thirdly, one in front, near to the sternal border (*anterior or sternal point*), where the anterior perforating branch emerges beneath the skin.

For some unknown reason, the intercostal nerves, when inflamed, are particularly liable to be associated with the appearance of that form of skin disease called "herpes zoster." This may or may not be accompanied by neuralgic symptoms, but it is a valuable sign of a neuritis of the nerves supplying the region affected.

The diagnosis of intercostal neuralgia can often be made only with extreme difficulty. That rheumatic affection of the muscles of the chest commonly called "pleurodynia" is often confounded with it, and the diagnosis is to be made chiefly by the presence of the localized points of tenderness mentioned, and the rapid disappearance of all symptoms in the course of a few days, which is seldom observed in true intercostal neuralgia. Pleurisy is also to be differentiated from this disease chiefly by its physical symptoms; and angina pectoris is to be told by the phenomena presented by the heart and the pulse, as well as by the sense of impending death, threatened suffocation, intense anxiety, and the fact that the pain frequently shoots down the left arm.

#### NEURALGIA OF THE MAMMARY GLAND (MASTODYNIA).

The skin over the mammary gland is supplied by the anterior and lateral branches of the second, third, fourth, fifth, and sixth intercostal nerves, and by some filaments derived from the supra-clavicular nerves, while the glandular struct-

ure itself is supplied by the lateral perforating branches of the fourth, fifth, and sixth intercostal nerves. This region is especially liable to an extreme form of neuralgia, first described by Sir Astley Cooper under the name of "irritable breast." So intense is the pain in some cases of this affection that it is compared to the sensation of cutting, tearing, or stabbing the part with a knife. It is usually paroxysmal in character, and generally of short duration, although such attacks may last for some hours.

This affection seems to be associated with pregnancy, anæmia, chlorosis, hysteria, and the development of neuromata upon the nerves of this region. It may be persistent and remain for years, and is particularly obstinate to treatment.

The detection of painful points is to be looked for in the region of the escape of the nerves which supply the part from the inter-vertebral foramina; and, in some instances, the existence of similar points may be detected upon the breast, near the nipple, and upon the sides of the gland. The attacks are particularly liable to exacerbate during the menstrual periods, and, during the height of the paroxysm, the pain may be transmitted by other nerves into the neck, down the arm, and over more extended areas upon the chest and back.

#### PARALYSIS OF THE DORSAL NERVES.

The dorsal muscles control, to a great extent, the movements, fixation, and upright position of the vertebral column, but these conditions require such a complexity of muscular action that it is often difficult, in case of paralysis, to exactly decide as to the muscles which are affected. Various degrees of weakness of the dorsal muscles are often present in youth, sometimes on one side and sometimes on the other, and occasionally affecting the whole back to a greater or less extent.

These parietic states are dependent upon rheumatic affections, diseases or injuries of the vertebral column, disturbances of the motor regions of the cerebrum, lesions of the

various ganglia of the encephalon, and lesions of the kinesodic system of the spinal cord. In paraplegia, the motor paralysis often extends upward to the muscles of the trunk; while, in progressive muscular atrophy, the muscles of the dorsal region are not infrequently involved.

If the muscles of both sides of the back be paralyzed, the spinal column gradually tends to assume the condition of a posterior curvature (paralytic kyphosis), and the deformity is usually most marked in the dorsal region, as the lumbar and cervical regions exhibit it to a less degree on account of their anatomical peculiarities. If the extensor muscles of the back be markedly affected, the spinal column forms an equable curve, as if the body were bent forward as in old age, and the patient becomes unable to voluntarily straighten the trunk to its normal posture. When passive straightening is attempted, the spine is easily brought into its proper curve; and this is a point of diagnosis between paralytic kyphosis and the deformity dependent upon structural disease of the vertebræ or a state of muscular contracture.

The muscles most frequently affected are the sacro-lumbalis and the latissimus dorsi. If they be paralyzed upon one side only, the deformity assumes the type of scoliosis, as a lateral curvature is produced by the muscles of the unaffected side. In this case, as in the one before cited, the patient is unable to rectify the deformity by any voluntary muscular effort, although the spinal curve can be easily removed by mechanical aid.

When the *extensor muscles* of the *lumbar region* are markedly impaired, the attitude assumed by the patient is very characteristic. It consists of a bending of the upper portion of the trunk in a backward direction, so as to compensate for the bending forward of the lumbar vertebræ; this bending of the thorax backward brings the upper part of the body behind the center of gravity of the whole body, and the balance is preserved exclusively by the action of the muscles of the abdomen. When the body is brought too far forward, it sinks and falls, as the lumbar muscles fail to support it in



an erect posture. The patient can not then bring the trunk into its former posture without the use of the hands, which are employed in a sort of a climbing process, the hands being

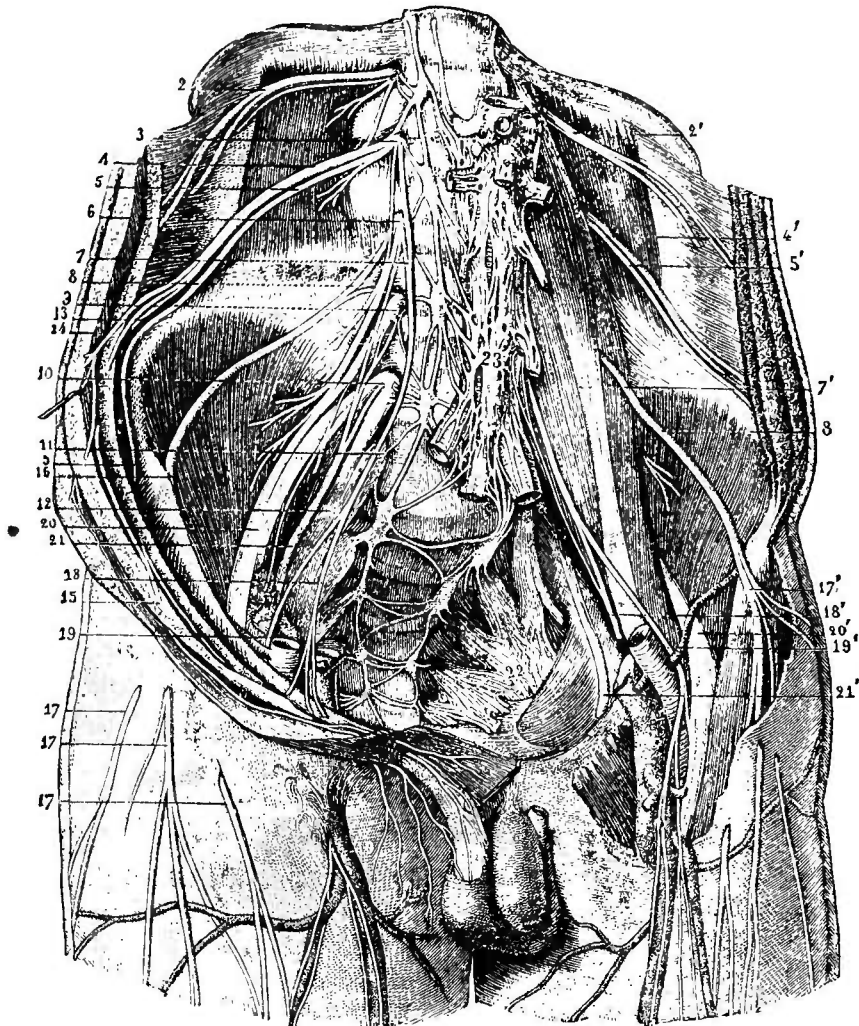

FIG. 162.—*The lumbar plexus.* (Hirschfeld.)

- 1, lumbar and sacral portions of the great sympathetic; 2, twelfth dorsal pair; 3, first lumbar pair; 4, 4', ilio-hypogastric branch; 5, 5', ilio-inguinal branch; 6, second lumbar pair; 7, origin of the genito-crural branch; 7', this same branch appearing and descending in front of the psoas muscle; 8, origin of the external cutaneous nerve; 8', this same branch leaving the border of the psoas, and dividing at the level of the fold of the groin; 9, third lumbar pair; 10, fourth lumbar pair; 11, fifth lumbar pair; 12, lumbo-sacral trunk; 13, gluteal branch of the ilio-hypogastric; 14, its abdominal branch; 15, its genital branches; 16, external cutaneous passing under Poupart's ligament, between the anterior superior and inferior spines of the ilium; 17, 17, 17, divisions of this branch; 17', point of origin of these divisions; 18, 18', genital branch of the genito-crural nerve; 19, 19, femoral division of this nerve piercing the fascia lata in the neighborhood of the saphenous opening; 19', this division exposed at the fold of the groin, to show its relations with the femoral artery and the saphenous vein; 20, 20', anterior crural nerve; 21, 21', obturator nerve.

placed upon the legs; a series of peculiar movements of the shoulders and trunk then follow, which are employed to assist

the arms in tossing the trunk backward to an extent sufficient to allow the abdominal muscles once more to support it. This difficulty in bringing the trunk above the level of the lower limbs is typical of this condition, but there are still other additional points of diagnostic value. The lumbar region presents a deep hollow; the head is bent forward in standing or walking; and the trunk may be seen to have a remarkable oscillating movement when the patient walks. When the patient sits down, the upper portion of the body seems to sink, and the spine presents a condition of kyphosis. In fact, it seems hardly possible that the condition can be mistaken by one well versed in anatomy.

#### THE LUMBAR NERVES.

The lumbar nerves comprise five pairs which escape from the intervertebral foramina of that region. Like all the spinal nerves, they each divide, immediately after their escape, into anterior and posterior divisions, the former of which has a larger proportion of motor, while the latter has an excess of sensory fibers. These nerves are of special interest, from the fact that the anterior divisions of the four upper nerves assist to form the lumbar plexus. This plexus is situated in the substance of the psoas muscle, in front of the transverse processes of the lumbar vertebræ. It is narrow above, where it is joined to the last dorsal nerve, but below it becomes broad, and is connected with the sacral plexus by means of the lumbo-sacral cord and a filament from the fourth lumbar nerve. The table which I now show you will give you an opportunity of contrasting the relative arrangement of the anterior and posterior divisions of the lumbar nerves, as well as of studying the origin of the seven main nerve trunks given off from the lumbar plexus.

In the following table the formation of the *lumbar plexus* is shown, as well as the branches which are given off from each nerve which assists to form it.

TABLE OF THE NERVES OF THE LUMBAR REGION.<sup>1</sup>

LUMBAR NERVES.	POSTERIOR DIVISIONS.	External branches.	Internal branches.	LUMBAR PLEXUS.	Filaments to erector spinæ muscle,	Given off by the 1st LUMBAR NERVE.	
					Filaments to the inter-transversales muscles,		
					Filaments to <i>integument</i> of back part of gluteal region.		
					Filaments to multifidus spinæ muscle, Filaments to <i>integument</i> near spinal column.		
	ANTERIOR DIVISIONS	1ST LUMBAR nerve.	2D LUMBAR nerve.	3D LUMBAR nerve.	4TH LUMBAR nerve.	Ilio-hypogastric nerve,	Given off by the 2d LUMBAR NERVE.
						Ilio-inguinal nerve,	
						Communicating to 2d lumbar.	
						Genito-crural nerve, External cutaneous nerve,	
ANTERIOR DIVISIONS	1ST LUMBAR nerve.	2D LUMBAR nerve.	3D LUMBAR nerve.	4TH LUMBAR nerve.	Communicating to 3d lumbar.	Given off by the 3d LUMBAR NERVE.	
					Part of anterior crural nerve,		
					Part of obturator nerve,		
					Part of accessory ob- turator nerve, Communicating to 4th lumbar.		
ANTERIOR DIVISIONS	1ST LUMBAR nerve.	2D LUMBAR nerve.	3D LUMBAR nerve.	4TH LUMBAR nerve.	Part of anterior crural nerve,	Given off by the 4th LUMBAR NERVE.	
					Part of obturator nerve,		
					Part of accessory ob- turator nerve,		
					Lumbo-saeral cord.		

It will be perceived that three most important nerves, viz., the *anterior crural*, the *obturator*, and *accessory obturator* nerves, are formed by branches both of the third and fourth lumbar nerves, and therefore may be said to arise by two heads. The *accessory obturator nerve*, however, arises occasionally by a branch derived only from the fourth lumbar nerve, its other head being a branch given off from the obturator nerve.

The second table, to which I now call your attention, is constructed to show the distribution of each of the seven large branches of the lumbar plexus. This table may aid in refreshing your memories while following the subsequent lectures, while it also gives you, at a glance, a better conception of the arrangement of any special nerve than a mere verbal description.

<sup>1</sup> Taken from "The Essentials of Anatomy" (Darling and Ranney). New York: G. P. Putnam's Sons, 1880.

TABLE OF THE DISTRIBUTION OF THE BRANCHES OF THE LUMBAR PLEXUS.<sup>1</sup>

LUMBAR PLEXUS.	(1) ILIO-HYPO- GASTRIC.	{	<i>Iliac branch.</i>	{	<i>Integument of gluteal region.</i>			
			<i>Hypogastric branch.</i>	{	<i>Integument of the hypogastric region.</i>			
		(2) ILIO-IN- GUINAL.	{	<i>Internal oblique muscle,</i>				
				<i>Integument of upper and inner portion of thigh,</i>				
		(3) GENITO- CRURAL.	{	<i>Genital branch.</i>	{	<i>Cremaster muscle,</i>		
				<i>Crural branch.</i>	{	<i>Serotum,</i> <i>Round ligament of female.</i>		
		(4) EXTERNAL CUTANEOUS.	{	<i>Anterior branch.</i>	{	<i>Integument of the front and upper portion of the thigh.</i>		
				<i>Posterior branch.</i>	{	<i>Integument on the anterior and outer aspect of thigh, as low as the knee.</i>		
		(5) ANTERIOR CRURAL.	{	Anterior division.	<i>Middle cutaneous nerve.</i>	{	<i>The sartorius muscle,</i> <i>Integument of anterior aspect of thigh, as low as the knee.</i>	
					{	<i>External branch.</i>	{	<i>Integument of inner and outer sides of knee.</i>
						<i>Posterior branch.</i>	{	<i>Integument of inner sides of the thigh and the leg.</i>
					Posterior division.	<i>Long or internal saphenous nerve.</i>	{	<i>Integument of knee joint and front and inner sides of the leg and foot.</i>
						<i>Muscular branches.</i>	{	<i>All the muscles on front of thigh except the tensor vaginae femoris and the sartorius.</i>
						<i>Articular branches.</i>	{	<i>Two in number. Distributed to capsule of knee joint, and probably to the hip joint.</i>
				<i>Articular branches.</i>		{	<i>To hip joint.</i>	
{	<i>Muscular branches.</i>			{		<i>To gracilis,</i> <i>To adductor longus,</i> <i>To pectineus,</i> <i>To adductor brevis.</i>		
	<i>Anastomotic branches.</i>			{		<i>With internal cutaneous nerve,</i> <i>With internal saphenous nerve.</i>		
(6) OBTURATOR NERVE.	{			Anterior branch.	<i>Articular branches.</i>	{	<i>To knee joint.</i>	
					<i>Muscular branches.</i>	{	<i>Obturator externus,</i> <i>Adductor magnus.</i>	
				Posterior branch.	<i>Muscular branch.</i>	{	<i>To pectineus.</i>	
		<i>Articular branches.</i>	{		<i>To hip joint.</i>			
(7) ACCESSORY NERVE	{	<i>Articular branches.</i>	{	<i>To hip joint.</i>				
		<i>Cutaneous branches.</i>	{	<i>To the integument of thigh and leg.</i>				

<sup>1</sup> Taken from "The Essentials of Anatomy" (Darling and Ranney). New York: G. P. Putnam's Sons, 1880.

## THE ILIO-HYPOGASTRIC NERVE.

This nerve is named, from its two terminal filaments of distribution, the iliac and hypogastric branch. It is given off by the first lumbar nerve in company with the ilio-inguinal. It emerges from the outer border of the psoas muscle, crosses the quadratus lumborum, then perforates the transversalis muscle of the abdomen, and finally divides between it and the internal oblique muscle into its iliac and hypogastric branches.

The *iliac branch* pierces the internal and external oblique muscles just above the crest of the ilium, and supplies the skin of the gluteal region, while the *hypogastric branch* pierces the internal oblique and the aponeurosis of the external oblique muscle a little above the external abdominal ring, and supplies the skin of the hypogastrium. In some cases the ilio-inguinal nerve is incompletely developed, and this nerve may then be traced downward to the skin of the penis, scrotum, labium, and thigh.

## THE ILIO-INGUINAL NERVE.

This nerve arises, in common with the preceding nerve, from the first lumbar nerve, but it is smaller in point of size than its fellow. Like the ilio-hypogastric, it pierces the outer border of the psoas, and crosses the quadratus lumborum muscle, lying below the preceding nerve; it then pierces the transversalis muscle, enters the inguinal canal, passes throughout the entire length of that canal in front of the spermatic cord, and supplies the skin of the penis, scrotum, labium, and of the upper and inner portions of the thigh. It is sometimes incompletely developed, in which case the ilio-hypogastric nerve takes its place.

## CLINICAL POINTS PERTAINING TO THE ILIO-HYPOGASTRIC AND ILIO-INGUINAL NERVES.

These two nerves are sometimes the seat of a severe form of neuralgia. It may be produced by disease of the lumbar

vertebræ, structural changes in the parts investing the lumbar plexus, pelvic diseases, exudations in the substance of the psoas muscle, strains, contusions, exposure, and an hysterical condition. The pains are usually of a paroxysmal character, and radiate in the course of these nerves; they are of a lancinating type, and often extremely severe. Painful points may be detected in one of the following regions, or possibly in all of them: 1, a *lumbar point*, near the spinous processes of the lumbar vertebræ; 2, an *iliac point*, near to the middle of the crest of the ilium, where the ilio-hypogastric nerve pierces the transversalis muscle; 3, an *hypogastric point*, slightly above the external ring, where the ilio-hypogastric nerve pierces the aponeurosis of the external oblique muscle; 4, an *inguinal point*; and 5, points upon the *scrotum* or *labium*. It is stated by Notta<sup>1</sup> that this type of neuralgia may be occasionally accompanied by an increase in the sexual appetite, and a spasmodic contraction of the cremaster muscle.

This form of neuralgia is to be diagnosed from rheumatic myalgia of the longissimus dorsi and sacro-lumbalis muscles, and from those types of chronic affections of the uterus which induce pain in the back. It might also be possibly mistaken for an attack of renal or biliary colic. The diagnosis will be made chiefly by the "*puncta dolorosa*"<sup>2</sup> previously described, by the course of the pain, and by its intense paroxysmal and lancinating character.

The nerves which are distributed to the skin of the abdominal walls may be considered as comprising two distinct sets, based on the physiological action of the abdominal muscles which are supplied by them. According to Hilton, the abdomen may be divided, on a line corresponding with the situation of the umbilicus, into an upper or respiratory portion, and a lower or abdominal portion. The upper or respiratory portion is supplied, in great part, by the lower intercostal nerves, which are distributed also to the muscles of the

<sup>1</sup> As quoted by Erb.

<sup>2</sup> A name applied by Valleix to the spots of extreme local tenderness found along the course of a nerve which is the seat of neuralgia.

chest, and which, if taken with the other intercostal nerves as a group, are essentially respiratory in their function. The lower or abdominal portion of the abdomen is supplied chiefly by the ilio-hypogastric nerve, although the ilio-inguinal, the genito-crural, and the posterior branches of the lumbar nerves assist in furnishing motor power to the muscles of that region.

The subjacent peritonæum is unquestionably supplied from the same sources of nerve power as the muscles and skin of the individual regions of the abdomen, and it is considered probable by the author above quoted that the spinal nerves which are distributed to the skin, muscles, and parietal peritonæum may be also associated with the visceral layer underneath, by means of communications with the sympathetic nerve. The abdominal muscles unquestionably assist the colon in its endeavors to force the fæces, by its peristaltic action alone, throughout its length, since the force of gravity has to be overcome in its ascending portion, and the curves of the sigmoid flexure in its terminal portion. It would therefore be an additional confirmation of a general law of nerve distribution, provided the distribution of the abdominal nerves to the intestinal covering of peritonæum could be fully verified; since the structures which assist in moving the adjacent organs—the abdominal muscles—would be supplied from the same source as the parts moved, as well as the skin over those muscles.

#### THE EXTERNAL CUTANEOUS NERVE.

This nerve arises from the trunk of the second lumbar nerve, in common with the genito-crural, but it usually receives a few filaments from the third lumbar. It pierces the psoas muscle, near to its central point, and crosses the iliacus muscle in order to reach a notch below the anterior superior spine of the ilium, where it escapes below Poupart's ligament.

The anterior branch of this nerve pierces the fascia lata at about four inches below Poupart's ligament, and supplies the integument of the anterior and outer aspects of the thigh, while the posterior branch supplies the integument of the outer and posterior aspects of the same region. Both of these

the physiological interest which other nerves possess, still it is possible to imagine certain localized conditions of the psoas and iliacus muscles, local swellings in the vicinity of Poupert's ligament, and possible forms of vertebral disease which might be manifested exclusively through the medium of these nerves.

#### THE ANTERIOR CRURAL NERVE.

This is the largest branch of the lumbar plexus. It arises mainly from the third and fourth lumbar nerves, but often receives a fasciculus from the second. In its course, it perforates the psoas muscle, emerging from it at the lower part of its outer border. It then passes between the psoas and iliacus muscles, and enters the thigh by escaping under Poupert's ligament about one half inch to the outer side of the femoral artery. Its main divisions (the middle and internal cutaneous and long saphenous nerves) are given off after it enters the thigh. The distribution of each of these terminal branches is shown you upon the table,<sup>1</sup> but I would call your attention to some points of special interest pertaining to the anterior crural nerve, which will perhaps enable you to appreciate the value which some portions of this table possess.

The anterior crural nerve supplies nearly all of those muscles which are employed in the *first effort of progression*. As the act of taking a step forward is performed, we flex the thigh upon the pelvis, we extend the leg at the knee, and we slightly evert the foot.<sup>2</sup> Now, all the muscles which aid us in performing these various movements—the psoas and iliacus, the pectineus and sartorius, the four muscles of the quadriceps extensor, and the subcrureus—are supplied by the anterior crural nerve. This nerve also sends branches both to the knee joint and hip joint; the capsular ligament of the former, as well as that of the latter,<sup>3</sup> being supplied by filaments which can easily be demonstrated by dissection. If we

<sup>1</sup> See page 438 of this volume.

<sup>2</sup> John Hilton, *op. cit.*

<sup>3</sup> This fact is not so stated by all of the text-books upon descriptive anatomy, but, nevertheless, I regard it as capable of demonstration.



now consider, in the third place, that the cutaneous branches of this nerve supply the skin of the thigh, and also the regions over the two joints mentioned, we are enabled to again

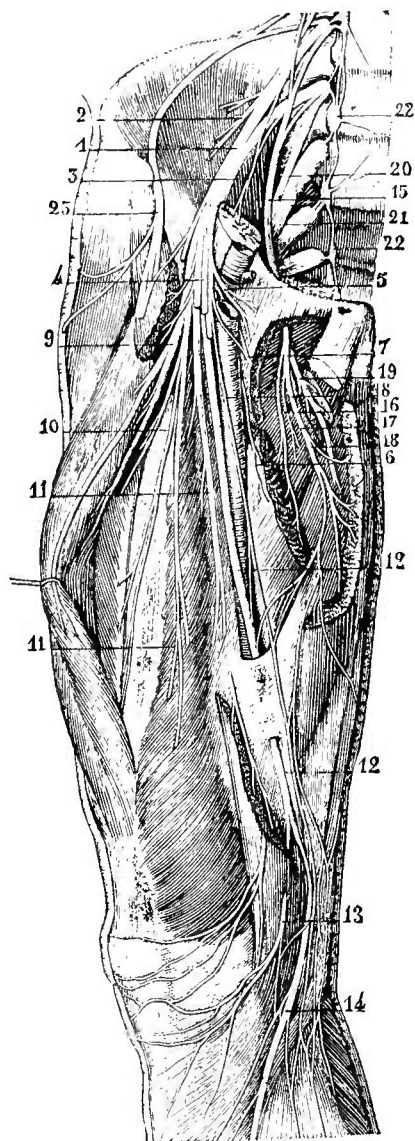

FIG. 164.—*The muscular branches of the anterior and internal portions of the thigh.*  
(Sappey.)

- 1, anterior crural nerve ; 2, branch which it furnishes to the iliacus muscle ; 3, twig which it sends to the internal portion of the psoas muscle : 4, middle cutaneous branch of the anterior crural, whose three branches have been divided close to their origin in order to show the branches to the quadriceps extensor and the internal saphenous nerve, which are more deeply placed ; 5 and 6, muscular filaments of the internal cutaneous nerve ; 7, origin of the cutaneous branches which pierce the fascia lata at the level of the saphenous opening ; 8, deep or anastomotic filament of the internal cutaneous branch of the anterior crural ; 9, branches to the rectus muscle ; 10, branches to the vastus externus ; 11, branches to the vastus internus ; 12, 12, internal saphenous nerve ; 13, patellar branch of this nerve ; 14, its vertical or tibial branch ; 15, obturator nerve ; 16, branch which it furnishes to the adductor longus ; 17, branch to the adductor brevis ; 18, branch to the gracilis ; 19, branch to the adductor magnus ; 20, lumbo-sacral trunk ; 21, junction of this nerve with the first sacral nerve ; 22, 22, lumbar and sacral portions of the sympathetic ; 23, external cutaneous nerve.

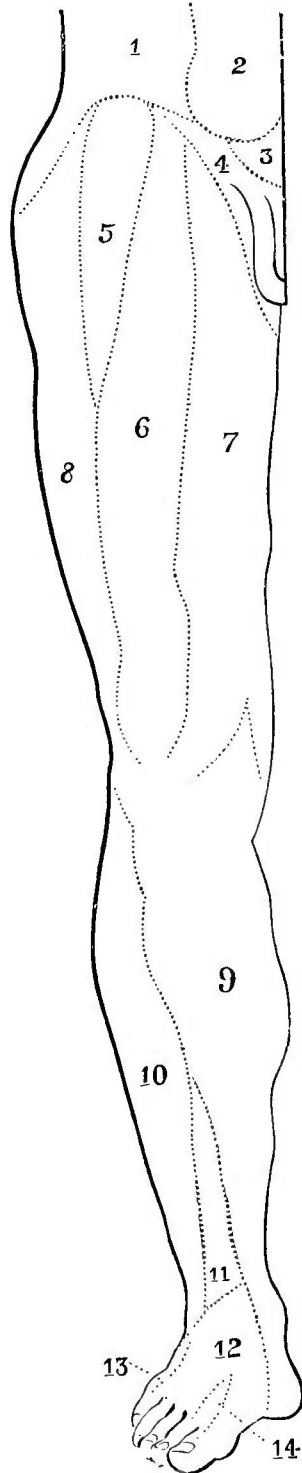

FIG. 165.—A diagram of the cutaneous supply of the anterior aspect of the lower extremity.

1, region supplied by the lateral branches of the intercostal nerves; 2, region supplied by the anterior branches of the intercostal nerves; 3, region supplied by the ilio-hypogastric nerve; 4, region supplied by the ilio-inguinal nerve; 5, region supplied by the genito-crural nerve; 6, region supplied by the middle cutaneous branch of the anterior crural nerve; 7, region supplied by the internal cutaneous branch of the anterior crural nerve and partly by the obturator nerve; 8, region supplied by the external cutaneous nerve; 9, region supplied by the long saphenous branch of the anterior crural nerve; 10, region supplied by the branches of the external popliteal nerve; 11, region supplied by the musculo-cutaneous nerve; 12, region supplied by the terminal filaments of the musculo-cutaneous nerve; 13, region supplied by the external saphenous nerve; 14, region supplied by the anterior tibial nerve.

record a confirmation of that axiom of Hilton,<sup>1</sup> that a nerve which supplies a joint must supply also muscles which move that joint, and the skin over the insertion of those muscles. The long saphenous nerve seems, at first sight, to extend far beyond the limits of the muscular distribution of the anterior crural, but, when we look closely into the anatomical relations of the fascia of the leg, we find that the muscles supplied by the anterior crural nerve are attached to it, especially the sartorius, whose insertion into this fascia is as intimate as that of the biceps into the fascia of the forearm; and we also notice that the cutaneous distribution over this fascia is derived from the same sources as are the muscles which are attached to it. This fact is in perfect accord with the axiom given in a previous lecture, viz., that a fascia, to which muscles are attached, must be considered as one of the points of insertion of the muscles connected with it, and that the cutaneous distribution over such a fascia will be found to be derived from the nerves which supply those muscles. We thus discover in the lower extremity the same general laws of nerve distribution, as were verified in connection with the upper extremity, fully carried out; and it is thus that many of the apparent deviations from the natural order of nerve supply may be explained by, and often act as guides to, the presence of some anatomical fact, whose physiological importance had either not been recognized or properly appreciated.

#### CLINICAL POINTS PERTAINING TO THE ANTERIOR CRURAL NERVE.

The relation of this nerve to the femoral artery as it passes underneath Poupart's ligament and its still more intimate relation with that vessel in Scarpa's space render it of special interest to the surgeon. Its internal cutaneous branches cross the upper part of the femoral artery in that space, before it becomes properly a cutaneous nerve; while the long saphenous nerve lies to the outer side of that vessel for nearly its entire length, being at first slightly removed from it, but

<sup>1</sup> *Op. cit.*

approaching it more closely in the lower part of its course. This latter nerve also bears an intimate relation with the internal saphenous vein for the greater portion of its course; hence the pain experienced from varicose veins in this region.<sup>1</sup>

It is customary with surgeons to regard a *pain* which is localized at the *inner side of the knee* (since the obturator nerve is distributed to that region) as strongly diagnostic of disease of the hip joint, because that nerve is supposed to have an intimate connection with the internal structures of the hip. So strongly is this impression grounded in the minds of some of our prominent surgical authors that the presence of pain in any other locality than that just mentioned is not considered as particularly indicative of morbus coxarius; and the inference is certainly implied, if not directly stated, that the accuracy of diagnosis of this condition can be questioned if this symptom be not confined to the region supplied by the obturator nerve. I am not prepared to admit that pain in the knee is always present in morbus coxarius, nor am I inclined to think that the anterior crural nerve, from its distribution to the capsular ligament of the hip joint, can not also be one of the sources of sympathetic pains referred to the knee, in case the hip be diseased. I admit that the obturator nerve, from its distribution to the internal structures of the hip joint,<sup>2</sup> is the most frequent source of transmission of these sympathetic pains; but the sciatic and anterior crural nerves may also indicate an irritation of their filaments to the capsule of the hip by pains referred to the other regions which they supply.

*Spasm* of the quadriceps extensor muscle, which is supplied by the anterior crural nerve, is often observed in articular neuralgia of the knee joint; while the rigid extension of the leg upon the thigh, met with in tetanus, is dependent upon irritation of this nerve. In his treatise upon nervous

<sup>1</sup> Varicose veins are most common on the inner side of the leg. The pain of these tumors may often be arrested by simple elevation of the foot, since the excess of blood in the part is thus relieved.

<sup>2</sup> It is claimed by Hilton that this nerve is distributed chiefly to the ligamentum teres, and that this accounts for it being so frequently affected by disease of the hip joint.

diseases, Eulenberg reports a case of clonic spasm localized in the quadriceps extensor muscle which was induced whenever an attempt to walk or stand was made, but such cases are of rare occurrence.

*Paralysis* confined to the anterior crural nerve is not of common occurrence, but is still observed as a result of injuries to the vertebral column and pelvis, from tumors and extravasations of blood in the region of the cauda equina, and as a sequel to a severe type of inflammation of the knee joint. It has been known to occur in connection with psoas abscess and simple inflammation of the psoas muscle; while fractures of the thigh, cuts, stab wounds, neuritis, pelvic tumors, and tumors of the thigh, have been reported as inducing this type of paralysis. Finally, it is a frequent symptom of spinal paralysis in all of its forms, and, more rarely, of cerebral paralysis and of progressive muscular atrophy.

From what has been already said as to the distribution of this nerve to muscles, it is easy to understand that the symptoms of this type of paralysis will be confined to the inability of the anterior thigh muscles to perform their accustomed functions. Such patients can not flex the leg at the hip joint or raise the body from the recumbent position; neither are they able to extend it nor to move the leg

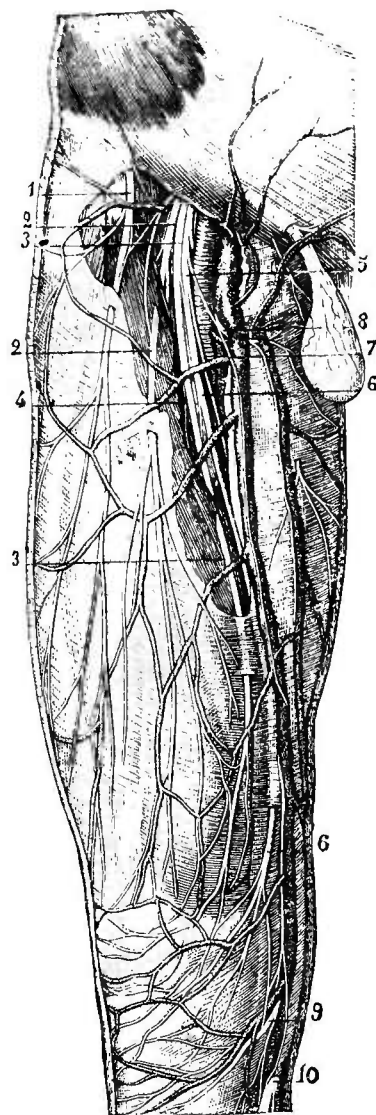

FIG. 166.—Cutaneous nerves of the anterior part of the thigh. (Sappey.)

- 1, external cutaneous branch of the lumbar plexus; 2, 2, external cutaneous or superior perforating branch of the anterior crural nerve; 3, 3, middle cutaneous or inferior perforating branch of this nerve; 4, filament furnished by this branch to the serotum; 5, internal cutaneous branch of the anterior crural nerve; 6, superficial division of this branch; 7, deep division of the same; 8, superficial division of the small musculocutaneous branch of the anterior crural; 9, transverse or patellar branch of the internal saphenous nerve; 10, internal, vertical, or tibial branch of the same.

and foot forward when sitting. For this reason standing and walking are rendered very insecure, and such acts as running, jumping, etc., are often impossible with patients so afflicted. The regions of the skin which are supplied by the anterior crural nerve may manifest disturbances of sensibility. If the scrotum, labium, hypogastrium, or inguinal regions exhibit the same disturbances of sensibility, the seat of the paralysis is positively indicated as being above the origin of the branches of the two upper lumbar nerves (ilio-hypogastric, ilio-inguinal, genito-crural, and external cutaneous nerves). Among the evidences of disturbed sensibility which you may be called upon to recognize may be mentioned the conditions of anæsthesia, hyperæsthesia, the sensations of furriness, numbness, and chilliness.

*Atrophy* of the muscles supplied by the anterior crural nerve may follow such paralysis. This is generally so well defined as to be apparent to the naked eye when the two thighs are compared; but it may, occasionally, be so slight as to require careful measurement of the thighs. In some cases, certain muscles exhibit this atrophy more than others of the group, and even parts of muscles may appear flaccid, relaxed, and shrunken, while others preserve their normal appearance.

*Crural neuralgia* may be manifested by paroxysms of pain upon the anterior and inner surfaces of the thigh and leg. It may affect the inner border of the dorsal surface of the foot and large toe. It is less frequent than neuralgia of the sciatic nerve, which affects the back of the leg and plantar region of the foot. This diseased condition may result from compression of the lumbar plexus, from degeneration of neighboring lymphatic glands, exudations upon or in the substance of the psoas muscle, aneurism of the iliac arteries, strangulated hernia of the femoral region, dislocations at the hip joint, traumatism, exposure to cold or dampness, coxalgia, etc. The diagnostic points of tenderness are detected as follows: 1, a *crural* point, at the exit of the nerve below Poupert's ligament; 2, an *anterior femoral point*, at the place of exit of the saphenous nerve through the fascia lata; 3, an

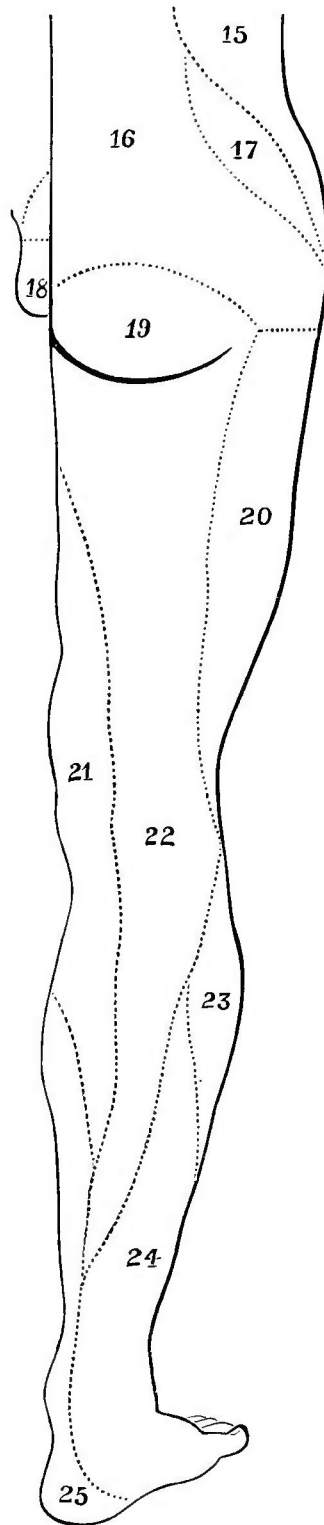

FIG. 167.—A diagram of the cutaneous supply of the posterior aspect of the lower extremities.

15, region supplied by the lateral branches of the intercostal nerves; 16, region supplied by the posterior branches of the lumbar nerves; 17, region supplied by the iliac branch of the ilio-hypogastric nerve; 18, region supplied by the pudic nerve; 19, region supplied by the inferior gluteal branch of the small sciatic nerve; 20, region supplied by the external cutaneous nerve; 21, region supplied by the internal cutaneous branch of the anterior crural nerve; 22, region supplied by the small and great sciatic nerves; 23, region supplied by branches from the external popliteal nerve; 24, region supplied by the external saphenous nerve; 25, region supplied by the posterior tibial nerve.

*articular* point, at the inner side of the knee joint, where the nerve divides; 4, a *plantar point*, on the inner side of the foot; and, finally, 5, a *digital point*, over the tuberosity of the big toe.

*Spasm* of the muscles of the hip, supplied by the anterior crural nerve (the spasmodic contracture of Stromeyer), may occur from any of the causes of crural paralysis previously mentioned. The thigh is then flexed, the pelvis raised up on the affected side, and the limb shortened and made rigid.

#### THE OBTURATOR NERVE.

This nerve arises mainly from the third and fourth lumbar nerves, but it often receives a fasciculus from the second. It descends in the innermost fibers of the psoas muscle, as far as the level of the brim of the pelvis, when it escapes from the inner border of that muscle, crosses the sacro-iliac articulation, accompanies the obturator vessels along the outer wall of the pelvis lying slightly above them, and passes into the thigh through the upper part of the obturator foramen.

The table,<sup>1</sup> previously referred to, will enable you to grasp the details of the subdivisions of this nerve, and the distribution of each branch; but it fails to point out some important facts pertaining to this nerve, which help to explain its physiological attributes and to elucidate its clinical bearings.

In the first place, we can see by this table that the obturator nerve sends filaments to the hip joint and the knee joint. To the former articulation two filaments of this nerve can be traced, one given off to the capsular ligament, as the nerve passes through the obturator foramen, the other given off to the ligamentum teres in the region of the notch in the acetabulum; while, in the case of the knee joint, the obturator nerve sends filaments which enter that articulation at its posterior part, and which are probably intimately associated with its internal structures. The close relation which this nerve bears to the sacro-iliac articulation renders it probable

<sup>1</sup> See page 438 of this volume.



that some small filaments from the obturator nerve could be traced to this joint, although anatomical authors do not mention this fact as proven. In relation to this point, I quote from

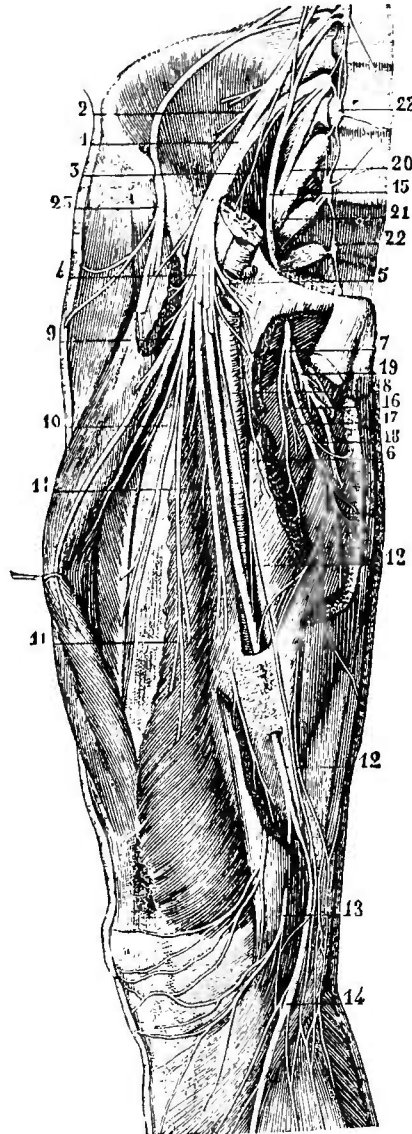

FIG. 168.—*The muscular branches of the anterior and internal portions of the thigh.* (Sappey.)

1, anterior crural nerve ; 2, branch which it furnishes to the iliacus muscle ; 3, twig which it sends to the internal portion of the psoas muscle ; 4, middle cutaneous branch of the anterior crural, whose three branches have been divided close to their origin in order to show the branches to the quadriciceps extensor and the internal saphenous nerve, which are more deeply placed ; 5 and 6, muscular filaments of the internal cutaneous nerve ; 7, origin of the cutaneous branches which pierce the fascia lata at the level of the saphenous opening ; 8, deep or anastomotic filament of the internal cutaneous branch of the anterior crural ; 9, branches to the rectus muscle ; 10, branches to the vastus externus ; 11, branches to the vastus internus ; 12, 12, internal saphenous nerve ; 13, patellar branch of this nerve ; 14, its vertical or tibial branch ; 15, obturator nerve ; 16, branch which it furnishes to the adductor longus ; 17, branch to the adductor brevis ; 18, branch to the gracilis ; 19, branch to the adductor magnus ; 20, lumbo-sacral trunk ; 21, junction of this nerve with the first sacral nerve ; 22, 22, lumbar and sacral portions of the sympathetic ; 23, external cutaneous nerve.

the most excellent monograph of Hilton<sup>1</sup> as follows: "I am disposed to think it sends some filaments to that articulation, or, at any rate, it lies close to it and would be likely to suffer from its proximity to it when diseased." Now, this distribution to the internal portions of two joints, and possibly to a third, is the best possible explanation of the fact that the obturator nerve is the most frequent source of transmission of sympathetic pains, in case the hip joint be the seat of the disease, since the situation of its filaments causes it to perceive the first inflammatory changes within the hip; and the effects of this irritation are naturally manifested in its terminal filaments—in the knee joint and the skin upon the inner side of that articulation.

When we consider the course of the obturator nerve more in detail, we will perceive that *pain in the region of the knee* may be due to other causes than morbus coxarius. It may be the external evidence of disease of the third or fourth lumbar vertebræ, of disease of the sacro-iliac articulation, of a psoas abscess pressing upon it, and, if the pain be confined to the left side, a distention of the sigmoid flexure of the colon by fæces, or a malignant tumor of that portion of the colon or of the rectum might create pain in this region. It is well, therefore, when a patient suffering from a pain localized upon the inner aspect of the knee joint is brought to you, to carefully examine all the different portions of the course of the obturator, anterior crural, and sciatic nerves before you decide as to the exciting cause of the pain, remembering always that pain can be perceived through no other structures than the nerves which are distributed to the region where the pain is felt, and that, by following the course of the nerve suffering from irritation, the seat of the disease to which the pain is due may be confidently sought for.

The distribution of the obturator nerve affords us some lessons as to the physiological groupings of the muscles which act upon the thigh and leg. It first supplies the obturator externus, and then the adductor brevis, the adductor longus,

<sup>1</sup> *Op. cit.*

the adductor magnus, and the gracilis. In some cases the pectineus is supplied by this nerve or the accessory obturator nerve, but its chief source of supply is undoubtedly from the anterior crural. This fact would seem to indicate that the gracilis muscle, whose supply from the obturator nerve is very constant, should be classed as an adductor muscle, rather than as a flexor, and that this is its true action seems well proven on mechanical principles. Its point of insertion is just below the central point of the limb which it moves, hence, it seizes the limb just beyond the central point, between the fulcrum (the hip joint) and the resistance, and is thus able to greatly assist the adductor muscles. The obturator nerve is thus, physiologically considered, the *adductor nerve* of the lower extremity, while the muscles which it supplies also act as external rotators of the thigh, on account of the obliquity of their fibers. That the pectineus muscle acts as a flexor as well as an adductor is proven by its nerve supply, as well as by the direction of its fibers and its points of origin and insertion, since it receives filaments both from the anterior crural and obturator.

#### CLINICAL POINTS PERTAINING TO THE OBTURATOR NERVE.

The diagnostic value of pain in the region of the knee joint as an evidence of disease in other localities, to which the obturator nerve is either distributed or with which it bears some intimate relations, has been discussed already at some length.<sup>1</sup> Such a pain may be dependent, however, also upon lesions interfering with the free action of the anterior crural and sciatic nerves, and, for that reason, the course of these three nerves should always be carefully examined before a positive diagnosis can be made as to the exciting cause of pain in the region of the knee.

The obturator nerve is even less frequently affected with isolated paralysis than the anterior crural, but, if so, it may be referable to the same list of causes. In addition to the causes mentioned, may be added, however, compression of the

<sup>1</sup> See page 448 of this volume.

obturator nerve from a strangulated hernia through the obturator foramen, the pressure exerted by the head of a fœtus during its passage through the pelvis, and the use of forceps during difficult labors.

From what has been said as to the supply of muscles by this nerve, it is apparent that a patient afflicted with obturator paralysis can not adduct the thigh, or perform the acts of pressing the knees tightly together or of crossing the affected leg over the other. Since the adductor muscles assist in the external rotation of the thigh, this movement is impaired, especially in the sitting posture, when the external rotators attached to the great trochanter are rendered inert. The affected leg soon becomes fatigued in walking, and riding upon horseback is difficult, since the knees can not grasp the saddle. Some disturbances of sensibility may be detected in the regions of the skin supplied by this nerve ; these will be the same in character as those mentioned as existing in crural paralysis.<sup>1</sup>

#### THE ACCESSORY OBTURATOR NERVE.

This nerve is sometimes wanting. When it is present, its origin is extremely variable. It may arise from the third and fourth lumbar nerves ; from the fourth lumbar and obturator nerves ; or by separate filaments derived from the second, third, and fourth lumbar nerves. It descends along the inner side of the psoas muscle, crosses in front of the pubes, passes behind the pectineus muscle, and there divides into branches to the pectineus and the hip joint. It usually gives off a large branch of communication to the obturator nerve (which is often larger than the continuation of the accessory nerve itself), and terminates as a cutaneous nerve to the thigh and leg.

The frequent absence of this nerve deprives it of any clinical importance, as it is impossible in any one case to decide if pain in the regions supplied by the obturator nerve is partly due to the accessory obturator or not, while the variations in

<sup>1</sup> See page 450 of this volume.

the method of origin of the nerve renders it impossible to definitely decide as to the seat of irritation, provided the pain could be traced to the accessory nerve and localized above the pelvis.

## THE SACRAL NERVES.

We now have reached, in the natural progress of this course of lectures, the terminal nerves of the spinal cord. As was the case with those of the lumbar region, the sacral nerves divide into anterior and posterior divisions, but they differ from the lumbar nerves in the fact that these anterior and posterior divisions escape from separate foramina in the sacrum, while, in the portions of the cord above the sacral region, the spinal nerves divide after their escape from the inter-vertebral foramina. These nerves form, by their anterior divisions and the addition of the lumbo-sacral cord, the sacral plexus; while their posterior divisions are distributed to the muscles of the lower lumbar region and to the integument of the gluteal, sacral, and coccygeal regions.

The *sacral plexus* is triangular in shape, and is formed by the lumbo-sacral cord, the three upper sacral nerves (their anterior divisions), and a portion of the fourth sacral nerve. Its constituent fibers converge to form one flattened cord, which leaves the pelvis through the lower part of the great sacro-sciatic foramen, below the pyriformis muscle, while, within the pelvis, the plexus lies upon the pyriformis muscle, and is covered by the pelvic fascia and the two terminal branches of the anterior division of the internal iliac artery (the sciatic and pudic). The branches which are given off by this plexus are arranged, in the table which I now show you, in such a way as to make them apparent to the eye, while the distribution of each is shown in the next table in detail. The first table is not intended to exhibit alone the branches of the sacral plexus, but rather to give the general arrangement of the

sacral nerves in their entirety. You will perceive that the arrangement of both the anterior and posterior divisions is considered, and that the component parts of the sacral plexus, as well as its main subdivisions, are clearly set forth.

NERVES OF THE SACRAL REGION.<sup>1</sup>

SACRAL NERVES.	Posterior divisions.	External branches.	Form anastomotic loops on the back part of the sacrum and on the posterior aspect of the great sacro-sciatic ligament, Terminate in <i>cutaneous branches</i> in the gluteal region.				
		Internal branches.		Are distributed to the multifidus spinæ muscle, The back part of the coccyx is supplied by the two lower nerves.			
SACRAL NERVES.	Anterior divisions.	LUMBO-SACRAL CORD.	SACRAL PLEXUS.	(1) SUPERIOR GLUTEAL NERVE,			
		1ST SACRAL nerve.			(2) MUSCULAR BRANCHES,		
		2D SACRAL nerve.				(3) SMALL SCIATIC NERVE,	
		3D SACRAL nerve.					(4) GREAT SCIATIC NERVE,
		PART OF 4TH SACRAL nerve.					
	(6) ARTICULAR.						

Each of the five branches of the sacral plexus, as well as those included in the muscular group, to which no special names are given, will now be separately described. I have endeavored to embrace in this second table all the points pertaining to the purely anatomical distribution of each of these nerves, but much of interest, from a clinical aspect, still remains in relation to some of them, which can not be shown in a tabular form. This table will, however, prove of assistance to you in reviewing the distribution of the nerve which is, at any time, under discussion, and, furthermore, avoid lengthy descriptions of a purely anatomical character.

<sup>1</sup> Taken from the "Essentials of Anatomy" (Darling and Ranney). G. P. Putnam's Sons, New York, 1880.

DISTRIBUTION OF THE BRANCHES OF THE SACRAL PLEXUS.<sup>1</sup>

SACRAL PLEXUS.	SUPERIOR GLUTEAL.	Superior branch.	{	Gluteus medius muscle, Gluteus minimus muscle.	
		Inferior branch.	{	Gluteus medius muscle, Gluteus minimus muscle, Tensor vaginae femoris.	
	MUSCULAR branches.	Pyriformis, Obturator internus, Gemellus superior, Gemellus inferior, Quadratus femoris.			
	ARTICULAR branches.	To hip joint.			
	SMALL SCIATIC NERVE.	Inferior gluteal branch.	{	Gluteus maximus muscle, Integument of the side of the penis or vulva, Integument of perinaeum,	
		Inferior pudendal branch.	{	Integument of upper and inner part of the thigh, Integument of scrotum or labium.	
		Cutaneous branch.	Ascending.	{	Integument over the gluteus maximus muscle,
			Descending.	{	Integument of the inner and outer sides of posterior aspect of the thigh.
	GREAT SCIATIC NERVE.	Articular (to the hip joint).			
		Muscular	{	Adductor magnus, Semi-membranosus, Semi-tendinosus, Biceps flexor cruris.	
Terminal		{	EXTERNAL POPLITEAL NERVE, INTERNAL POPLITEAL NERVE.		
PUDIC NERVE.	Perineal	{	Cutaneous or superficial perineal. { Integument of anal region, serotum, penis, and labia, Sphincter ani muscle.		
		{	Muscular { Muscles of the perinaeum.		
	Inferior hemorrhoidal. Dorsal nerve of penis.		{	Integument of the dorsum of the penis, Branch to corpora cavernosa of the penis.	

THE SUPERIOR GLUTEAL NERVE.

This nerve arises from the back part of the lumbo-sacral cord, and, while generally included as a branch of the sacral plexus, can not be, therefore, properly regarded as a nerve of sacral origin. It escapes from the pelvis through the upper part of the great sacro-sciatic foramen, in company with the gluteal vessels, lying above the pyriformis muscle. It divides into a superior and an inferior branch, as is shown in the table<sup>2</sup> to which I have called your special attention, the former of which accompanies the superior gluteal artery between

<sup>1</sup> Modified from a table taken from "The Essentials of Anatomy" (Darling and Ranney). G. P. Putnam's Sons, New York, 1881.

<sup>2</sup> See page 459 of this volume.

the gluteus medius and minimus muscles, while the latter passes between the same muscles, but lower than its fellow.

The distribution of this nerve to the gluteus medius, gluteus minimus, and tensor vaginæ femoris muscles, stamps it as the one which presides chiefly over the act of *internal rotation of the thigh*, since these three muscles are the only ones which can perform this limited movement of the femur. Its cutaneous distribution again confirms the axioms of Hilton;<sup>1</sup> since the skin over these muscles is thus supplied, while some filaments running over the fascia lata, to which the tensor vaginæ femoris is attached, can be demonstrated.

#### CLINICAL POINTS PERTAINING TO THE SUPERIOR GLUTEAL NERVE.

The cutaneous covering of the gluteus medius and minimus muscles is not alone supplied by the gluteal nerve, as the lumbar nerves may be seen coursing along over the lower part of the abdomen, then passing over the crest of the ilium, and finally reaching this part of the thigh. While this might seem, at a first glance, to be a peculiar admixture of lumbar and sacral nerves, yet, on returning to a point just made, we discover that the superior gluteal nerve is of lumbar origin, although apparently a branch of the sacral plexus; hence, the skin, supplied by branches of lumbar origin, protects all those regions to which muscular branches derived from the same sources can be traced. We see the region of the gluteus maximus muscle apparently avoided by the nerves which descend from the abdomen to supply the skin of the adjoining region, and, when we seek for an explanation of the fact, we find that this muscle is supplied by the small sciatic nerve (derived from the sacral plexus, and having no connection with the lumbar nerves); hence, the integument covering that muscle could not be supplied by nerves whose source of origin would prevent a perfect sympathy between the skin and the muscular structures which it covers.

The relation of this nerve to the gluteal artery, as it escapes from the great sacro-sciatic foramen, gives it a surgical

<sup>1</sup> See page 359 of this volume.

<sup>2</sup> Hilton, *op cit.*



importance, as that vessel is sometimes ligated for hæmorrhage from some of its branches.

The three muscles supplied by the superior gluteal nerve, if acting in connection with the gluteus maximus muscle, become the *abductors* of the hip joint, while the posterior half of the gluteus medius and the posterior fifth of the gluteus minimus assist in *extension* of the thigh upon the trunk, since their origin lies on a plane posterior to their insertion into the trochanter. Thus we are enabled to class the superior gluteal nerve as a factor in three of the movements of the hip joint, viz., internal rotation, abduction, and extension.

When the superior gluteal nerve is subjected to irritation, a *spasmodic condition* of the gluteal muscles may be produced. It is extremely rare to have such a condition developed in the glutei muscles alone, but one such case is reported by Remak. In this case the spasms of the legs consisted of a series of gluteal contractions which, when the patient would attempt to walk, would draw the leg backward and render it fixed in that position. We see, however, the glutei muscles frequently affected with spasm (in connection with muscles of the lower extremity supplied by other nerves) in tetanus, rheumatic inflammation of the hip joint, arthralgia, neuralgia, and lesions within the pelvis which affect the sacral plexus.

The gluteal muscles may be affected with *paralysis*, but it is rare that the paralysis is confined exclusively to that region. As a rule, these muscles become affected as the result of lesions which involve the sacral plexus to a greater or less extent, such as spinal diseases, tumors in the spinal canal or pelvis, lesions of the cauda equina, fractures of the sacrum, fractures of the pelvis, etc., so that the paralysis of the glutei muscles is masked by a similar condition of muscles supplied by other nerves. When the glutei muscles are paralyzed, in connection with the tensor vaginæ femoris, the pyriformis, and the obturator internus, as is more frequently observed, the rotation of the thigh inward becomes impossible, and out-

rotation; and it is to be remembered that this movement is but a secondary function with these latter muscles, since they are designed chiefly to insure adduction and flexion of the thigh. Each muscle of a group is usually supplied by that nerve whose branches are also distributed to others of that group which aid in its primary action, rather than in any secondary movement in which it may chance to participate; hence the psoas and iliacus derive their power from the anterior crural, the adductor muscles from the obturator, and the five muscles posterior to the hip joint from the sacral plexus, and thus the primary action of each group is indicated by the nervous supply, as well as by the points of origin and insertion of each muscle.

#### THE SMALL SCIATIC NERVE.

This branch of the sacral plexus is given off from its lower and posterior part, and escapes from the pelvis through the sacro-sciatic foramen, below the pyriformis muscle, in company with the sciatic vessels. It descends beneath the gluteus maximus muscle, in which region it lies to the inner side of the great sciatic nerve, and continues beneath the fascia lata as low down as the popliteal space, where it perforates this fascia and joins with the external saphenous nerve, giving off also cutaneous branches of its own to the popliteal space and the back of the calf.

The branches of this nerve, which are enumerated in the table,<sup>1</sup> comprise the inferior gluteal, the inferior pudendal, and the cutaneous filaments distributed over the gluteus maximus muscle, and the regions previously mentioned. The fact that this nerve supplies the gluteus maximus muscle with motor power gives it an importance to the anatomist, since this muscle is one of the most important factors in regulating the position of the trunk and the lower extremity during all the various attitudes assumed by the living subject; but there are also some suggestions of value which have been thrown out by previous authors upon anatomy which will

<sup>1</sup> See page 459 of this volume.

merit your closest attention, especially as they are omitted in some of the descriptive text-books.

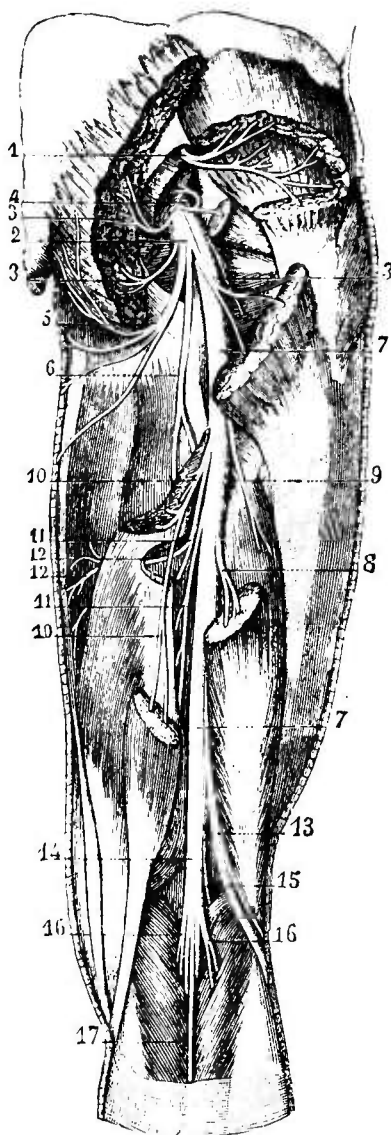

FIG. 169.—*The small sciatic nerve, with its branches of distribution and termination.*  
(Sappey.)

1, superior gluteal nerve; 2, small sciatic nerve; 3, 3, 3, branches to the gluteus maximus; 4, branch to the pyramidalis; 5, internal pudendal branch of the small sciatic; 6, femoro-popliteal branch of the same nerve; 7, 7, trunk of the great sciatic; 8, branch which it gives to the long head of the biceps; 9, branch to the short head of the same muscle; 10, 10, branch to the semi-tendinosus (the latter muscle has been divided and turned back, to show the semi-membranosus); 11, 11, branch to the semi-membranosus; 12, 12, another branch, rising from the common trunk with the preceding nerve, and passing under the semi-membranosus to be distributed to the adductor magnus; 13, external popliteal nerve; 14, internal popliteal nerve; 15, filament to the plantaris; 16, 16, nerves to the gastrocnemius; 17, origin of the external saphenous nerve.

In the first place, this nerve sends filaments to the perinæum and *genitals* of the male and female, after supplying

<sup>1</sup> In the female, the filaments probably go to the *vulva* and *vagina*; but, in the male, the side of the penis is thus supplied.

the gluteus maximus muscle ; and the suggestion is made by Hilton, in reference to this point, that the action of this muscle in its *relation to coitus* may tend to explain the necessity for a sympathy between these two parts by means of a common nerve supply.

Again, the recognition of the perineal branch of the small sciatic nerve is sometimes important in practice. If you care to trace this nerve upon the dead subject, you will find that it escapes from beneath the perineal border of the gluteus maximus muscle, runs along the outer portion of the perinæum, and, finally, sends cutaneous filaments to the sides of the penis. The perineal region is also supplied by the perineal branches of the pudic nerve, which escape, posteriorly to those of the sciatic, from beneath the same muscle. Now, either of these two nerves may be the cause of a pain referred to the perinæum and the penis, and their points of escape from beneath the gluteus maximus muscle are so placed as to render them frequently subjected to pressure from sitting upon hard or uneven seats. It is thus possible for pains, referred to the penis, to be wrongly attributed to diseases of the bladder, calculus in the bladder, urethral troubles, and all other types of disease which are commonly indicated by more or less pain in that locality, when the cause may be found and correctly diagnosed by following up the course of the perineal branch of the small sciatic. Such a case is reported by Hilton, where prominent surgeons of Europe, among them Mr. Key, had diligently and unsuccessfully searched for the cause of a pain, referred to the penis, along the course of the pudic nerve, and where the patient had been treated for disease of the bladder, a careful examination subsequently revealing the true cause to be a spot of hardened tissue pressing upon the perineal branch of the small sciatic nerve, which was cured (as well as the pain which it created) by the application of nitric acid over the seat of thickening. It is, therefore, well to remember the course of this branch, as well as those of the pudic nerve, when investigating for the cause of pain in the penis or perinæum.

## THE PUDIC NERVE.

This branch of the sacral plexus arises from its lower part, and immediately escapes from the pelvis by means of the great sacro-sciatic foramen in company with the pudic artery, the sciatic vessels and nerves, and the gluteal vessels and nerves. The situation of the nerve in this foramen is on the inner side of the great sciatic nerve, both of which escape through the lower part of the foramen, beneath the pyriformis muscle. The pudic nerve then reënters the pelvis through the lesser sacro-sciatic foramen, in company with its artery, and immediately gives off its inferior hemorrhoidal branch. From this point the nerve passes along the outer wall of the ischio-rectal fossa, lying above the pudic artery (both artery and nerve being covered by the obturator fascia), and divides into the perineal branch and the dorsal nerve of the penis.

Of these three branches of the pudic nerve, the distribution has been given in a previous table, but with less detail than the subject, perhaps, demands.

The *inferior hemorrhoidal nerve* occasionally arises directly from the sacral plexus rather than as a branch of the pudic; its course runs along the ischio-rectal fossa, and it is distributed to the sphincter muscles of the rectum and the skin around the region of the anus. It communicates freely in this region with the superficial perineal and inferior pudendal nerves.

The *perineal nerve* is the largest branch of the pudic, and accompanies the superficial perineal artery. It divides into two sets of terminal filaments—the cutaneous or superficial perineal nerves and muscular branches. The former of these give a few twigs to the sphincter ani and levator ani muscles, but are chiefly distributed to the integument of the perinæum, scrotum, labium, and the penis, communicating freely, in the region of the anus, with the inferior hemorrhoidal nerve. The muscular branches usually arise from the pudic nerve by a common trunk, which passes forward and inward un-

derneath the transverse perinei muscle; its terminal filaments are given off to the transverse perinei, erector penis, accelerator urinæ, and compressor urethræ muscles, and a twig is often sent to the bulb of the urethra.

The *dorsal nerve of the penis* is the smaller terminal filament of the pudic nerve, which accompanies the pudic artery along the rami of the pubes and ischium, between the layers of the deep perineal fascia; it then pierces the suspensory ligament of the penis and continues its way along the dorsum of that organ as far as the glans penis. It gives a branch to the corpus cavernosum, and supplies the integument of the dorsum<sup>1</sup> of the penis; in the female the course of the nerve is about the same, although the size of the nerve is smaller, since the clitoris is minute in its size as compared with the organ of the male.

#### CLINICAL POINTS PERTAINING TO THE PUDIC NERVE.

A careful study of the distribution of the various branches of this nerve will show that it is the source of motion to the muscles of the perinæum and urethra, and of sensation to the integument of the perinæum, scrotum, labium, penis, and the mucous covering of the clitoris, as well as that lining the urethral canal. The friction made upon the cutaneous nerves of the external genital organs in the acts of sexual intercourse and masturbation creates a reflex act within the spinal cord, which creates the turgidity of the penis and clitoris during the first portion of those acts; and, later on, a series of muscular contractions in the perineal muscles and the involuntary muscular fiber of the urethral canal are produced, which assist in the expulsion of semen, in the male, and the secretion of the glands of Bartholine in the female. That this is the true explanation of emission is evidenced by the fact that onan-

<sup>1</sup> Hilton states that the integument of the sides of the penis is supplied by the *perineal branch* of the *inferior gluteal* nerve, and from no other source. This statement differs from most of the standard authors, but it seems to be supported by clinical demonstration. The reader is referred to page 466 of this volume, where the subject is discussed from its physiological and clinical point of view.

ism is most effectually prevented by blistering the cutaneous covering of the penis and the mucous covering of the clitoris.

In some cases of fracture of the spine, in the dorsal region, where a part of the spinal marrow is left intact below the seat of fracture, you may be able, by repeatedly pinching the skin of the scrotum and penis, to produce spasmodic contractions of the muscles of the perinæum and urethra, and often to effect a turgidity of the genital organ to such a degree as to make it resemble an imperfect erection or priapism.

The ejaculation of the last few drops of urine from the urethra is unquestionably effected by a reflex act through the sensory and motor fibers of the pudic nerve, in consequence of the irritation produced in the sensory fibers of the urethral mucous membrane from pressure of the urine or the contact of its saline ingredients.

It is not uncommon for rectal disease to produce sympathetic manifestations in the genito-urinary organs, in the form of neuralgic pains, involuntary emissions, incontinence of urine, etc.; such effects can only be explained by the distribution of the pudic nerve to the integument about the anus (and, I believe, to the walls of the rectum also), which allows reflex motor impulses to be sent from the spinal cord, in response to rectal irritation, to the genito-urinary organs and perineal muscles.

#### THE SCIATIC NERVE.

This nerve arises from the lumbo-sacral cord and the four upper sacral nerves, and is a direct continuation of the sacral plexus. It escapes from the pelvis through the great sacro-sciatic foramen below the pyriformis muscle, lying on the outer side of the pudic vessels and nerve. It then passes downward between the trochanter major of the femur and the tuberosity of the ischium, lying behind the external rotator muscles of the hip joint and the adductor magnus, to the lower third of the back of the thigh, where it divides into its two terminal branches, the external and internal popliteal nerves.

In the lower two thirds of its course, it is covered by the lower fibers of the gluteus maximus and biceps muscles. It

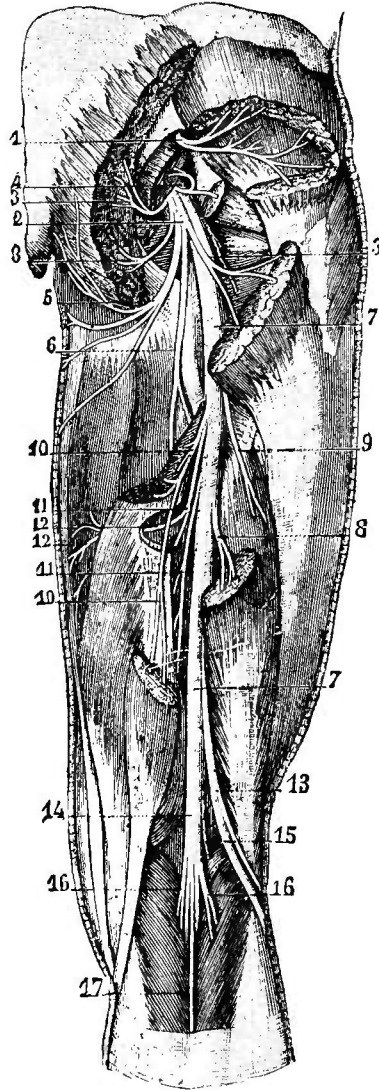

FIG. 170.—*The great sciatic nerve, with its branches of distribution and termination.*  
(Sappey.)

- 1, superior gluteal nerve; 2, small sciatic nerve; 3, 3, 3, branches to the gluteus maximus; 4, branch to the pyramidalis; 5, internal pudendal branch of the small sciatic; 6, femoro-popliteal branch of the same nerve; 7, 7, trunk of the great sciatic; 8, branch which it gives to the long head of the biceps; 9, branch to the short head of the same muscle; 10, 10, branch to the semi-tendinosus (the latter muscle has been divided and turned back, to show the semi-membranosus); 11, 11, branch to the semi-membranosus; 12, 12, another branch, rising from the common trunk with the preceding nerve, and passing under the semi-membranosus to be distributed to the adductor magnus; 13, external popliteal nerve; 14, internal popliteal nerve; 15, filament to the plantaris; 16, 16, nerves to the gastrocnemius; 17, origin of the external saphenous nerve.

gives off branches to the hamstring muscles and the adductor magnus, and some articular branches to the back of the hip joint. The two tables which I now show you are designed to



illustrate the branches given off by the external and internal popliteal nerves. The former of these is the smaller of the two, and passes along the outer side of the popliteal space close to the biceps muscle, while the other traverses the middle of the popliteal space as far as the lower border of the popliteus muscle, where it becomes the posterior tibial nerve.

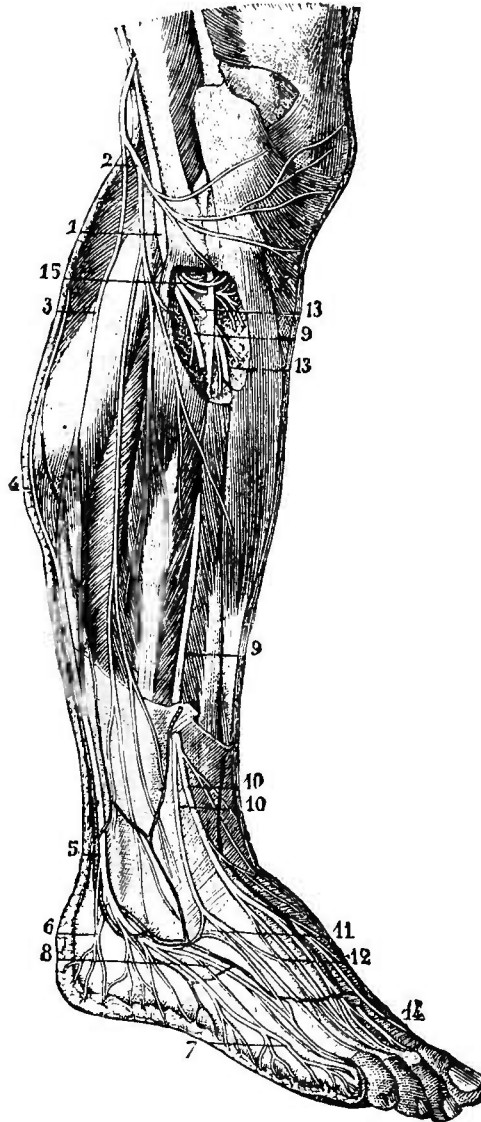

FIG. 171.—*The external popliteal nerve.* (Sappey.)

1, external popliteal nerve ; 2, peroneal or cutaneous branch ; 3, communicans peronei ; 4, external saphenous nerve ; 5, trunk formed by the junction of the external saphenous with the communicans peronei ; 6, calcanean branch rising from the trunk ; 7, external terminal branch of the trunk on its way to form the external dorsal branch of distribution to the fifth toe ; 8, its internal terminal branch which forms the internal dorsal branch for the fifth toe and the external dorsal branch for the fourth toe ; 9, 9, musculo-cutaneous nerve ; 10, 10, its terminal branches ; 11, anastomosis of its external terminal branch with the external saphenous ; 12, anastomosis of its internal and external terminal branches with each other ; 13, anterior tibial nerve ; 14, terminal portion of this nerve, anastomosing with the musculo-cutaneous, and dividing to form the deep branches of distribution on the dorsum of the foot to the internal side of the great toe and the external side of the second toe.

## NERVES OF THE LEG AND FOOT.

EXTERNAL POPLITEAL NERVE. (PERONEAL NERVE.)	{	(1) Articular branches.	{	Three in number, Distributed to knee joint.
		(2) Cutaneous branches.	{	Two or three in number, Supply <i>integument</i> of outer and back part of the leg.
		(3) ANTERIOR TIBIAL NERVE.	{	<i>Muscular</i> (to muscles in front part of leg and to the peroneus tertius). <i>External</i> branch. { Extensor brevis digitorum, Articulations of the tarsus. <i>Internal</i> branch. { <i>Integument</i> of the adjoining sides of the great and 2d toes.
		(4) MUSCULO-CUTANEOUS NERVE.	{	<i>Muscular.</i> { Peroneus longus, Peroneus brevis. <i>External</i> branch. { <i>Integument</i> of outer side of foot and ankle, <i>Integument</i> of the adjoining sides of 3d, 4th, and 5th toes. <i>Internal</i> branch. { <i>Integument</i> of the inner side of the foot and ankle, <i>Integument</i> of the adjoining sides of 2d and 3d toes and inner side of great toe.
INTERNAL POPLITEAL NERVE.	{	(1) Articular	{	Three in number, Distributed to knee joint.
		(2) Muscular	{	Gastrocnemius, Plantaris, Soleus, Popliteus.
		(3) EXTERNAL SAPHE- NOUS NERVE.	{	Formed by two filaments, one from each of the popliteal nerves, <i>Integument</i> of the outer side of foot and the little toe.
		(4) POSTERIOR TIBIAL NERVE.	{	<i>Muscular.</i> { Flexor longus pollicis, Flexor longus digitorum, Tibialis posticus. <i>Plantar</i> cutaneous. { <i>Integument</i> of heel and inner part of sole of foot. <i>Digital</i> branches. { <i>Integument</i> of the 3 $\frac{1}{2}$ toes on inner side of foot. <i>Muscular</i> { Flexor brevis digi- torum, Abductor pollicis, Flexor brevis pol- licis, Two inner lumbric- ales muscles. <i>Articular</i> (to tarsus), <i>Cutaneous</i> (to sole of foot). <i>Muscular</i> { Flexor accessorius, Abductor minimi digiti. <i>EXTERNAL</i> PLANTAR. { <i>Superficial</i> branch. { 1 $\frac{1}{2}$ outer toes, Flexor brevis mini- mi digiti. 4th interosseous muscle. <i>Deep</i> branch. { 3d and 4th lum- bricales, Rest of interossei, Adductor pollicis, Transversus pedis.

If you will study these tables, you will perceive that the external popliteal nerve distributes articular branches to the

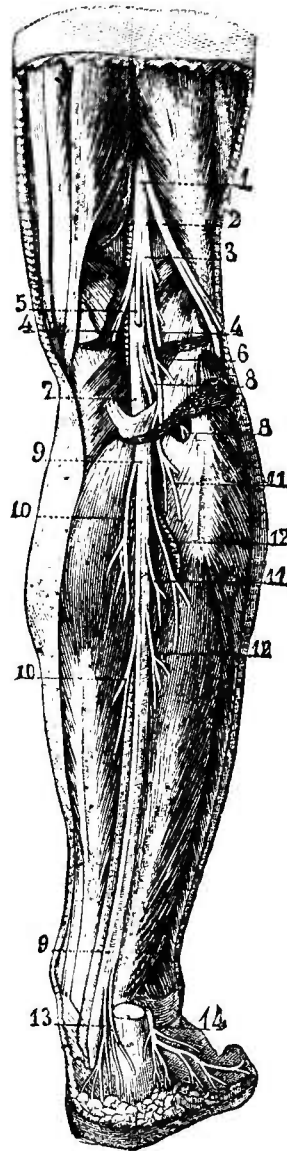

FIG. 172.—*The internal popliteal nerve.* (Sappey.)

1, trunk of the great sciatic; 2, external popliteal; 3, internal popliteal; 4, 4, branches to the gastrocnemius—both nerves and muscle have been divided; 5, origin of the external saphenous; 6, branch to the soleus, divided together with the muscle; 7, internal popliteal nerve passing through a fibrous ring in the soleus; 8, 8, branch springing from the lower portion of this nerve, and likewise passing through the fibrous ring of the soleus. At this level it gives off a reflected or ascending division, which penetrates the popliteus at its deep surface, but is not seen in the cut, and a more slender descending division which makes its way through the interosseous membrane and supplies the tibialis anticus muscle; 9, 9, posterior tibial nerve; 10, 10, branches which it furnishes to the flexor longus digitorum; 11, 11, branches which it gives off to the tibialis posticus muscle; 12, 12, branches to the flexor longus pollicis; 13, calcanean branches; 14, terminal extremity of the external saphenous nerve.

knee joint, and cutaneous filaments to the outer and back part of the leg. The two main nerve trunks which arise from

it are called the anterior tibial and the musculo-cutaneous, both of which are given off from the main trunk after it pierces the peroneus longus muscle about one inch below the head of the fibula, although three articular and several cutaneous filaments also arise from it. You will also perceive that four main branches are given off from the internal popliteal nerve, viz., articular and muscular branches, and the external saphenous and posterior tibial nerves. The muscular filaments supply four muscles in the immediate vicinity of the knee, while the articular filaments, as in the preceding nerve, are distributed to the knee joint. Other points of interest might be specially designated as comprised in these pages, but they will be considered in their practical relations when the clinical points which are presented by the nerves of the lower extremity are considered.

I desire to call your attention, first, to the fascia of the leg, into which three muscles of the thigh are inserted, viz., the sartorius, the gracilis, and the semi-tendinosus. I have already called your attention to the fact that the fasciæ of the body are always to be regarded as one of the points of insertion of the muscles which are attached to them; now, if this be true, and it undoubtedly is so, we ought to discover a particular distribution of the cutaneous nerves at this point, since the nerves which supply the muscles supply also the skin over the insertion of the same muscles. We shall find, on dissection of this region, that the long saphenous, the obturator, and a branch of the sciatic nerves are distributed in the skin of the calf; the one derived from the anterior crural (which supplies the sartorius), another a filament of the obturator (which supplies the gracilis), and the third derived from the sciatic (since it supplies the semi-tendinosus muscle). These three nerves, therefore, supply both the fascia of the leg and the skin on the inner side of the leg below the knee joint; hence, pain in this region must be sought for along the course of one of these three nerves. It is too common among physicians to regard a pain which is localized at the inner side of the knee as dependent

upon the obturator nerve, to the exclusion of the sciatic or the anterior crural; but anatomy clearly teaches us that

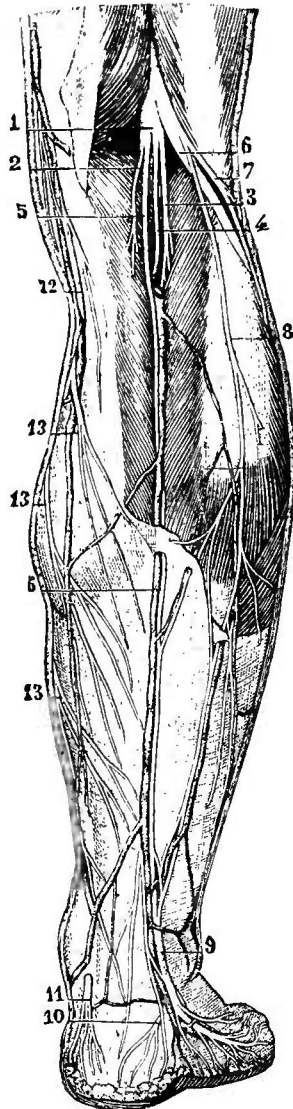

FIG. 173.—*The external saphenous nerve and its accessory, the communicans peronei.*  
(Sappey.)

1, internal popliteal nerve ; 2, nerve to the external head of the gastrocnemius ; 3, nerve to the internal head ; 4, external saphenous nerve ; 5, external popliteal nerve ; 6, communicans peronei ; 7, peroneal or cutaneous branch ; 8, branch sometimes given off by the external saphenous to the fourth and fifth toe ; 9, trunk formed by the junction of the communicans peronei with the external saphenous ; 10, calcanean branch given off by this trunk ; 11, plantar cutaneous branch of the posterior tibial ; 12, internal saphenous nerve ; 13, 13, 13, posterior branches of this nerve.

there are three possible lines of direction, which we are bound to explore in searching for the situation of the real cause which is producing it. We should always carefully examine all the anatomical relations of the obturator, the sciatic, and the anterior crural nerves, in order to ascertain, if possible, the real cause of pain which is expressed on the in-

ner side of the knee joint, and the axiom of nerve distribution, which was first pointed out by Hilton, and to which I have frequently directed your attention, offers us, in this instance, as in many others, a simple rule which should guide us in searching for the cause of pain before we attempt measures for its relief.

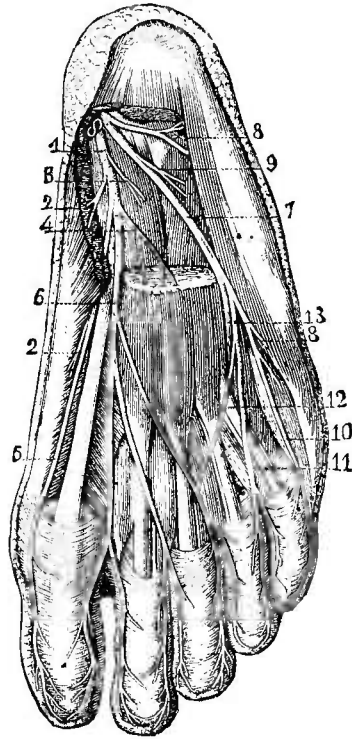

FIG. 174.—*The plantar nerves, their course, anastomoses, and distribution.* (Sappey.)

1, internal plantar nerve ; 2, 2, branches which it gives to the abductor pollicis ; 3, branch which it gives to the accessorius ; 4, branch to the flexor brevis digitorum ; 5, branch of distribution to the internal plantar surface of the great toe ; 6, another branch of the internal plantar dividing into three secondary portions, which subdivide, in their turn, to form the branches of distribution on the plantar surface to the outer side of the great toe, both sides of the second and third toes, and the inner side of the fourth toe ; 7, external plantar nerve ; 8, 8, branches which it sends off to the abductor minimi digiti ; 9, branch to the accessorius ; 10, branch of distribution on the plantar surface to the outer side of the little toe ; 11, another branch of the same nerve dividing to supply the inner side of the little toe and the outer side of the fourth toe ; 12, anastomosis of the internal with the external plantar ; 13, origin of the deep branch of the external plantar.

I have found, in several instances, that local anæsthetics, when applied to the skin over the seat of pain, frequently have the power of relieving a sense of distress in other regions apparently far removed from it, but still connected with the seat of pain by means of a nervous communication. Thus, in disease of the hip joint, an anodyne applied in the

region of the knee joint will often relieve symptoms which are referable to the hip, and we can only attribute this effect to a benumbing influence exerted by means of the sciatic and obturator nerves upon that joint, since both of these nerves send articular filaments to it, as well as cutaneous filaments to the region of the knee.

In some instances, where abnormalities of origin of nerve filaments can be detected, I believe that, if you will trace the nerve upward for some distance toward the spinal marrow, you will find that the cutaneous filaments of the nerve, which apparently has an abnormal origin, are in intimate communi-

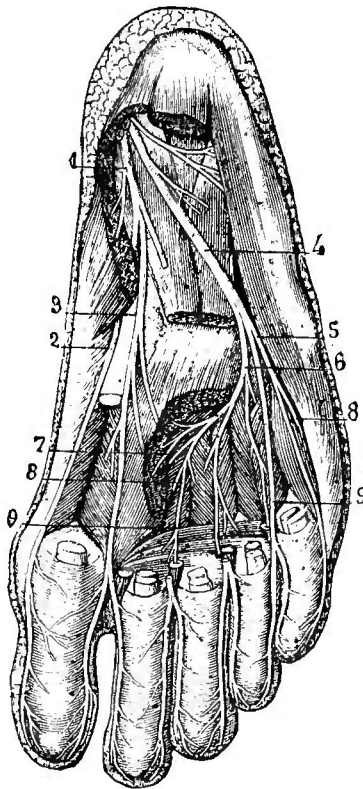

FIG. 175.—*The deep branch of the external plantar nerve.* (Sappey.)

- 1, internal plantar nerve ; 2, its internal branch ; 3, its external branch, whose two divisions have been cut, together with the adductor pollicis, to show the deep branch of the external plantar ; 4, trunk of the external plantar ; 5, its superficial branch, which divides almost immediately into two secondary branches, distributed to the fourth and fifth toes ; 6, its deep branch, distributed to the adductor pollicis, transversus pedis, and the interossei ; 7, branches to the adductor pollicis ; 8, 8, branches to the interossei ; 9, branches to the transversus pedis.

cation with the nerve trunk whose functions are assisted by them, and from which its most frequent origin can be verified.

If we examine the anatomy of the hip joint, we shall find

that a branch of the anterior crural nerve passes in close relation with its capsule, if it is not intimately associated with it; that a branch of the obturator nerve supplies its capsular ligament, and is ultimately distributed to the ligamentum teres; and, finally, that a branch from the sacral plexus supplies the hip joint at its posterior aspect, after sending filaments to the gemelli, the quadratus femoris, and the obturator internus muscles. The study of the anatomy of joints is of particular importance to the diagnostician, since it frequently explains how remote sympathetic pains may be dependent upon irritation of articular branches of a nerve, whose terminal cutaneous filaments are distributed to other regions, often far removed from the joint which it supplies. We know that disease of the hip joint, which is, perhaps, one of the most frequent which we meet with in practice, is often manifested, in its early stages, by a pain which is referred to the knee; and we can understand, from what has previously been said, that this sensation of pain must be transmitted through one of three sources, viz., the obturator, anterior crural, or the sciatic nerves.

CLINICAL POINTS PERTAINING TO THE NERVES DERIVED FROM THE SCIATIC, OR TO THE SCIATIC NERVE ITSELF.

The morbid conditions of the sciatic nerve or its branches which are most frequently met with comprise: 1, *neuralgia*, which may be articular or confined to the direct course of the sciatic nerve; 2, *spasmodic affections* of the muscles supplied by the sciatic nerve or its branches; and 3, *paralysis* of the different muscles supplied by the various nerve trunks.

SCIATICA.

This type of neuralgia—to which the name “*malum Cottunii*” is sometimes applied—may affect the greater portion of the back part of the thigh, a part of the gluteal region, the knee joint and patella, the anterior, lateral, and posterior surfaces of the leg, and the whole of the foot, with the excep-



tion of its internal border, which derives its nerve supply from the saphenous branch of the anterior crural nerve. It is seldom that all of these regions are affected at the same time, since the nerve may be subjected to a source of irritation which affects only individual branches. The most frequent seat of pain is confined, as a rule, to the posterior surface of the thigh and the upper half of the calf of the leg; but the external surface of the lower half of the leg and the corresponding part of the foot, as well as the sole, are often the seat of a neuralgic pain which is of a severe type. The disease is usually unilateral in character, and, if bilateral, a central cause may be suspected.

Among the causes of this type of neuralgia may be mentioned exposure to cold and dampness, malarial affections, inflammations of the nerve, injuries, pressure of tumors or inflammatory exudations, violent exertion, disturbances of the venous circulation of the pelvis, and mechanical pressure from sitting upon hard or uncomfortable seats, uterine displacement, pelvic tumors, aneurism, and hernia.

The beginning of this disease is usually associated with premonitory symptoms, among which may be mentioned a sensation of stiffness, cold, or heat in the affected regions, with occasional feelings of formication, or a fluid trickling over the skin. Soon painful electric pains are experienced, which show a marked paroxysmal character. These attacks occasionally occur without warning or premonitory symptoms. The pain is remarkably violent, and of a tearing and lancinating character, and usually follows the direction of the nerve trunk which is affected. It often changes its seat of greatest intensity, and the lines which connect the spots of greatest pain will generally conform to the anatomical course of the affected nerve. The pain is usually markedly increased by motion of the muscles, and the paroxysms seem to be excited by the most trivial causes, such as a draft of cold air, coughing, sneezing, sudden bending of the body, the contact of the clothes with the skin, or straining during the acts of defecation or micturition. If the whole area of the distribu-

tion of the sciatic nerve be involved, the pain occurs with special violence first in one and then in another branch, while the posterior branches of the sacral nerves may be also implicated, and the patient complain of violent pain in the sacrum and the loins.

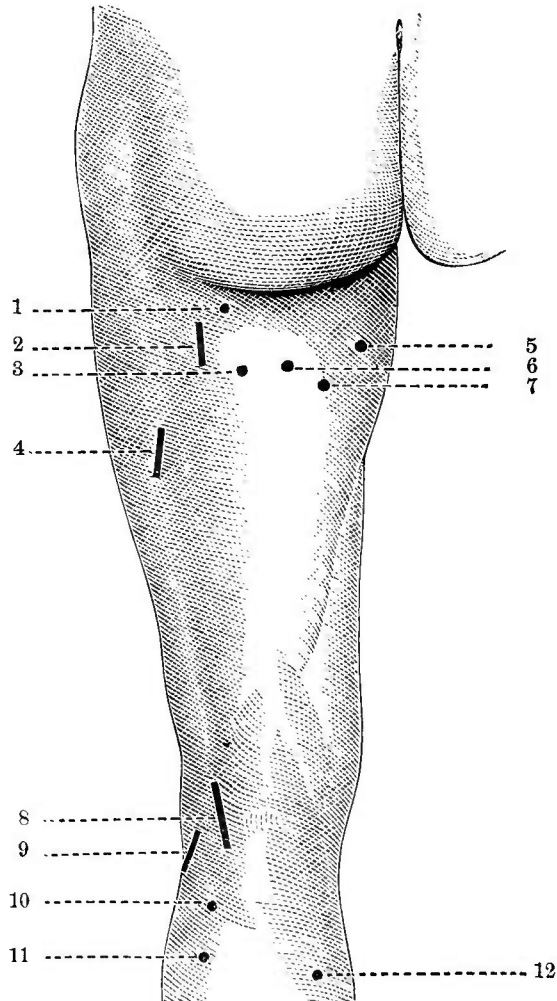

FIG. 176.—*The motor points on the posterior aspect of the thigh.*

1, branch of the inferior gluteal nerve to the gluteus maximus muscle; 2, sciatic nerve; 3, long head of biceps muscle; 4, short head of biceps muscle; 5, adductor magnus muscle; 6, semi-tendinosus muscle; 7, semi-membranous muscle; 8, tibial nerve; 9, peroneal nerve; 10, external head of gastrocnemius muscle; 11, soleus muscle; 12, internal head of gastrocnemius muscle.

As has been mentioned in other forms of neuralgia, certain painful points may usually be detected, which are diagnostic of neuralgia from those severe pains which accompany the early stages of locomotor ataxia. The most constant point of sensitiveness to pressure is stated by Valleix to correspond to the posterior superior spine of the ilium; another usually ex-

ists where the nerve escapes from the cavity of the pelvis; a third is often found at the lower border of the gluteus maximus muscle, where the posterior cutaneous branch emerges; the fourth corresponds to the head of the fibula, where the tibial nerve is given off; a fifth point is often discovered behind the internal malleolus; and, finally, there are frequent inconstant points in the thigh, on the calf of the leg, and on the dorsum of the foot, all of which correspond to localities where cutaneous branches either divide or perforate some fascia.

In connection with this neuralgic pain, certain *motor symptoms* are frequently developed. These comprise a peculiar limping gait, a mode of carrying the leg which is quite diagnostic, cramp of various degrees, and possibly convulsions, which are sometimes very violent. These symptoms are the result of direct and reflex irritation, and may be the forerunners of a condition of paresis or of actual paralysis.

Among the *vaso-motor disturbances* which accompany this disease may be mentioned paleness and coldness of the skin, in some instances accompanied by numbness and chilly sensations, and in other cases redness and heat of the skin, with increased perspiration, increased growth of the hair, herpes zoster along the course of the affected nerve, a saccharine condition of the urine, and hypertrophy and atrophy of the muscles.

Sciatica is to be diagnosed from disease of the hip joint; from locomotor ataxia in its early stages; from muscular rheumatism; and the pains of spinal disease, affecting the lateral columns, when the patient is subjected to extreme exertion.

#### SPASM OF THE LOWER LIMBS.

The muscles of the hip—especially the psoas, iliacus, quadratus lumborum, and adjacent muscles of the anterior surface of the thigh—may be the seat of tonic spasm, which has been named by Stromeyer “spasmodic contracture of the hip.” It may follow an inflammation or neuralgia of the hip joint, psoas abscess, or diseases of the lumbar vertebræ. In

this condition, the thigh is strongly flexed, the pelvis tilted upward, and the limb shortened; while passive extension creates a deviation of the body toward the affected side, and is extremely painful.

In rare instances, tonic and clonic types of spasm are observed in the extensor and adductor muscles of the thigh, as the result of neuralgia of the knee joint and certain spasmodic diseases of a central origin.

The flexor muscles of the leg may be affected with spasms in spinal affections, hysteria, diseases of the knee joint, and in inflammation of its adjacent muscles.

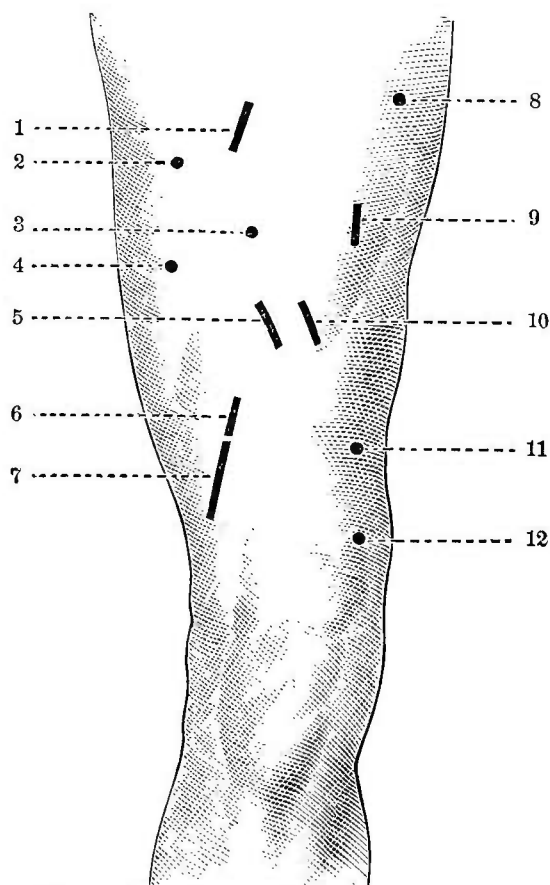

FIG. 177.—*The motor points on the anterior aspect of the thigh.*

1, crural nerve; 2, obturator nerve; 3, sartorius muscle; 4, adductor longus muscle; 5, branch of the anterior crural nerve for the quadriceps extensor muscle; 6, the quadriceps muscle; 7, branch of anterior crural nerve to the vastus internus muscle; 8, tensor vaginae femoris muscle (supplied by the superior gluteal nerve); 9, external cutaneous branch of anterior crural nerve; 10, rectus femoris muscle; 11, 12, vastus externus muscle.

In rare cases, the anterior muscles of the leg, which are supplied by the peroneal nerve, are affected with spasms as

the result of exposure to cold or dampness, over-exertion of the lower limbs, or paralysis of the antagonistic muscles; while the muscles supplied by the posterior tibial nerve, as well as those of the sole of the foot, are more frequently affected as the result of spinal affections, joint diseases, over-exertion, paralysis of other muscles, and by the reflex action of cholera.

PARALYSIS OF MUSCLES SUPPLIED BY THE SCIATIC NERVE OR ITS BRANCHES.

When we consider how extensively this nerve is distributed, and its exposed situation in various portions of its course, as well as its intimate relations to the organs of the pelvis, we can better appreciate the reasons for the frequency, on the one hand, and the importance, on the other, of the paralysis which may affect it or its branches. Among the causes of this form of paralysis may be enumerated all those conditions of the trunk which are capable of producing pressure upon the origin of the nerve; all forms of accidents which may result in laceration or section of the main trunk or any of its branches; the development of tumors in the course of the nerve; dislocations of bone; the compression of cicatrices; rheumatic conditions, from chilling or wetting of the lower extremities; surgical operations; and spinal diseases which impair its point of origin at the lumbar enlargement of the cord.

If the *peroneal nerve* be alone affected, the foot can not be flexed or abducted; neither can it be completely adducted. The dependent position of the foot, which hangs downward, interferes seriously with the act of walking, since the toe trips upon every slight elevation.

In order to walk, the patient is compelled to lift the foot by flexion at the hip joint, and places it insecurely upon the ground with the outer border of the toes first, thus producing a gait which is pathognomonic of this special type of paralysis. The arch of the foot becomes flattened from a loss of power in the *peroneus longus* muscle; the great toe can not

be extended, since the extensor longus pollicis is paralyzed ; flexion of the foot is impaired, since the extensor communis digitorum no longer acts ; and the abduction of the foot is rendered impossible, if the peroneus brevis be paralyzed, although the extensor communis digitorum may assist in this act coincidentally with dorsal flexion of the foot.

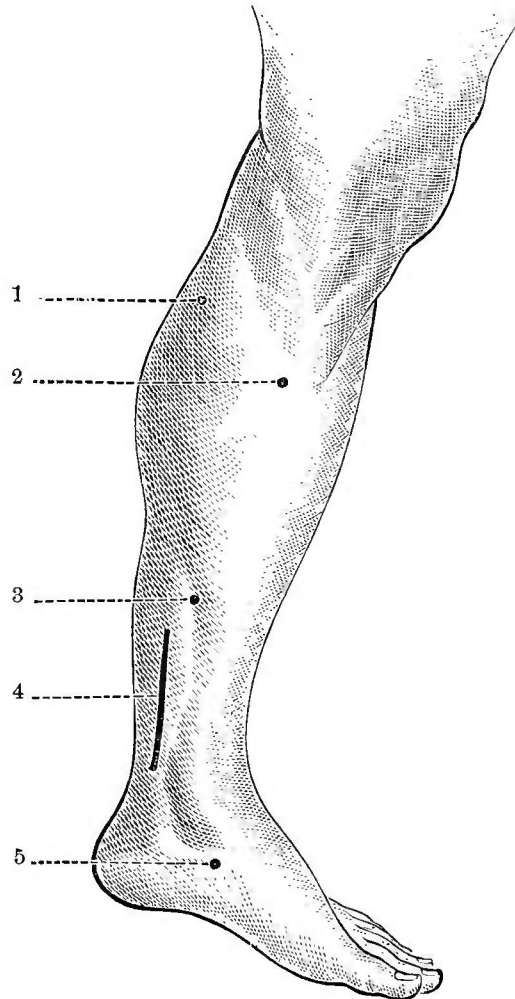

FIG. 178.—*The motor points on the inner aspect of the leg.*

1, internal head of gastrocnemius muscle ; 2, soleus muscle ; 3, flexor communis digitorum muscle ; 4, posterior tibial nerve ; 5, abductor pollicis muscle.

If the *tibial nerve* be paralyzed, a loss of power in the muscles of the calf is indicated by an inability on the part of the patient to extend the foot and to produce flexion and a lateral movement of the toes. Thus the patient is no longer able to stand upon the toes, while, in consequence of a secondary contracture of the muscles situated upon the anterior

surface of the leg, the foot is made to assume a position which has been compared to the shape of a hook. The tibialis posterior muscle no longer assists in adducting the foot and raising its inner border; the flexor communis digitorum can no longer flex the two distal phalanges of the toe, while paraly-

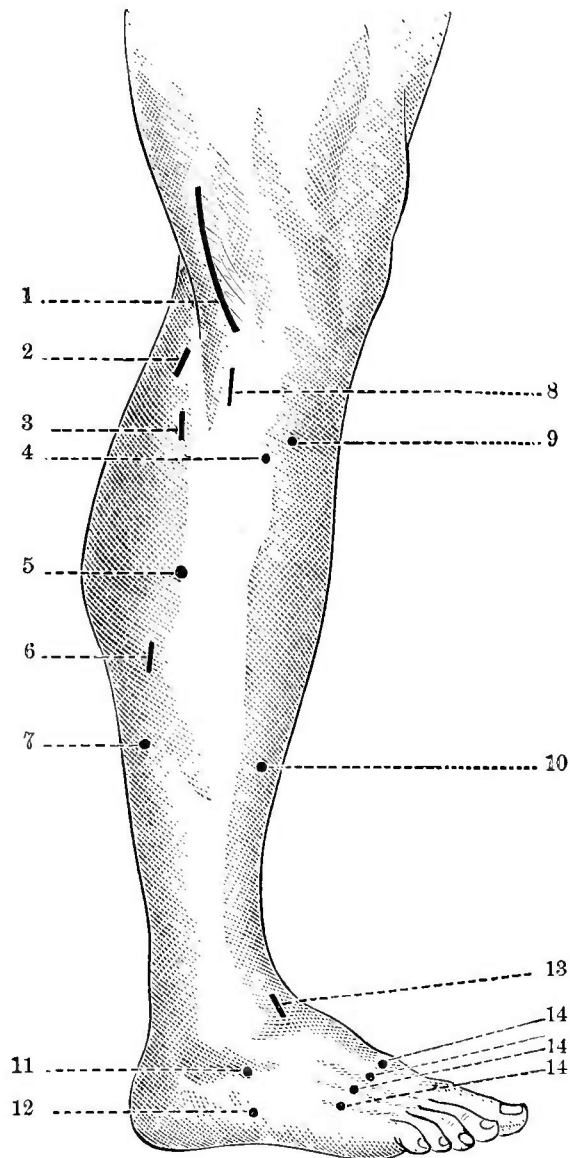

FIG. 179.—*The motor points on the outer aspect of the leg.*

1, peroneal nerve; 2, external head of gastrocnemius muscle; 3, soleus muscle; 4, extensor communis digitorum muscle; 5, peroneus brevis muscle; 6, soleus muscle; 7, flexor longus pollicis; 8, peroneus longus muscle; 9, tibialis anticus muscle; 10, extensor longus pollicis muscle; 11, extensor brevis digitorum muscle; 12, abductor minimi digiti muscle; 13, deep branch of the peroneal nerve to the extensor brevis digitorum muscle; 14, 14, 14, dorsal interossei muscles.

sis of the flexor longus pollicis deprives the patient of the power of flexing the great toe. A lateral motion of the great

toe is no longer possible, since the power of the adductor and abductor pollicis muscles is abolished, while paralysis of the interossei muscles (as mentioned also in connection with the hand) renders it impossible for the patient to flex the first phalanx, or extend the two distal phalanges of the toes, or separate the toes from each other. The peculiar position of the foot which results from this paralysis resembles that described in connection with the upper extremity as the "claw hand," since the first phalanx is abnormally extended, the second and third are strongly flexed, the toes are tightly compressed together, and their bulbous ends no longer touch the ground. The weight of the body in a standing position is borne upon the heads of the metatarsal bones. Hence, some pain and inconvenience are experienced after long standing or walking.

Paralyses of the *sciatic nerve* are accompanied, as a rule, by disturbances of the sensibility of the affected parts. Anæsthesia commonly exists over the regions supplied by the motor nerves to the muscles which are paralyzed; hence, this symptom may serve as a guide, in some cases, to the seat of the lesion which has created the paralysis. In addition to these disturbances of sensibility, you may often notice changes in the circulatory apparatus in the form of coldness of the skin, cyanosis, stasis in the veins, and a mottling of the part with bluish-red streaks.

The *trophic disturbances* which are commonly met with in severe forms of paralyses of the peripheral branches of the sciatic nerve comprise serious bed-sores on the heels, ankles, and over the sacrum; ulceration of the skin; eruptions of herpes and pemphigus; and, finally, marked atrophy of the muscles. When the sciatic nerve is affected by a spinal lesion above the cauda equina, the rectum and bladder are frequently completely paralyzed.



## I N D E X

- Æsthesodic system*, 313.  
—systematic lesions of, 315.  
*Ageusia*, its tests and clinical significance, 236.  
*Amaurosis*, 123, 126, 144.  
*Amblyopia*, 49, 50, 127.  
*Amyotrophic lateral sclerosis*, 329.  
*Anæsthesia*, its significance when combined with hemiplegia, 73.  
*Anæsthesia of locomotor ataxia*, 320.  
*Aneurismal cough*, 254.  
*Angular gyrus*, guide to, 72.  
— its function, 50, 52.  
*Anosmia*, its causes, and clinical significance, 102.  
*Aphasia*, its relations to embolism, 89.  
— surgical relief of, 73, 74.  
— traumatic, 73.  
— varieties of, and causes, 32.  
*Aqueduct of Fallopius*, 177, 182.  
— lesions within, 196.  
*Aqueduct of Sylvius*, its special center, 58.  
*Arm*, motor points of (cuts), 415, 416.  
*Arnold's nerve*, 239.  
*Artery*, middle cerebral, distribution of, 37.  
*Astigmatism*, its tests and clinical significance, 110, 111.  
*Ataxia*, changes of the pupils in, 323.  
— locomotor, 316.  
— "reflex tests" of, 323, 324.  
— symptoms of, 320, 321, 322.  
— tests for, 321, 322, 323.  
*Auditory nerve*, 198.  
*Auditory vertigo*, its clinical significance, 211.
- Basal ganglia*, effects of lesions of, 81.  
*Bell*, respiratory nerves of, 187.  
*Bell's paralysis*, 180, 181, 191, 192, 193, 194.  
— its effect on smell, 102.  
— its varieties, causes, and symptoms, 192, 193, 194, 195.  
*Bent arm*, its clinical significance, 387.  
*Bladder*, its relations to focal lesions of the spinal cord, 345.  
*Boulimia*, its clinical significance, 257.  
*Brachial plexus*, 378.  
— branches of inner cord of, 383, 384.  
— branches of outer cord of, 382.  
— branches of posterior cord of, 384.  
— communications of, 382.  
— cords of, 378, 379, 380.  
— (cuts), 379, 380.  
*Brain*, its anatomy, functions, and clinical aspects, 19.  
— clinical subdivisions of, 80, 81, 82.  
— component parts of, weight of, 22, 23, 24.  
— convolutions and sulci of, 75, 76, 77.  
— effects of destructive lesions of gray matter of (general summary), 89.  
— effects of diffused lesions of, 90.  
— effects of effusion into lateral ventricles, hæmorrhage, and softening of, 38.  
— effects of intra-cranial pressure, 82.  
— effects of irritative lesions of, 89.  
— effects of lesion in the median line of, 82.  
— effects of lesion of one lateral half of (general summary), 82.  
— embolism of, 34.  
— fourth ventricle of, its nuclei, 66.  
— functions of the cerebellum, 61.  
— function of cerebral convolutions (general deductions), 56.

- Brain, functions of crura cerebri, 59.  
 — functions of internal capsule of, 26, 91.  
 — function of lower portions of, 56.  
 — functions of medulla, 65, 66.  
 — functions of pons Varolii, 59, 61.  
 — ganglia of, 19, 20.  
 — general propositions relative to effects of lesions of its component parts, 81.  
 — general summary of its physiology and the effects of lesions of its substance, 82, 83, 84, 85.  
 — gray matter of, 19, 20.  
 — growth of, 23, 24.  
 — inferior aspect of (cut), 22.  
 — in profile (cut), 20, 21.  
 — special centers of motion of (cut), 39, 41.  
 — transverse vertical section of (cut), 22.  
 — weight of, 22, 24, 25.  
 Broca, center of, 32, 33.  
 — center of, surgical guide to, 71.  
 — the alveolo-condyloid plane of, 69.
- Canal, intestinal, effect of section of pneumogastric upon, 253.  
 Canals, semicircular, 200, 204, 206, 207.  
 — semicircular, effects of section of, 215, 216, 217, 218.  
 — semicircular, their relations to auditory vertigo, 215.
- Cardialgia, 257.  
 Central myelitis of spinal cord, 338.  
 Cerebellar ataxia, 64.  
 — vertigo, 62.  
 Cerebellum, effects of lesions of (general summary), 82.  
 — functions of, 61.  
 — its numerous connections, 63, 64.  
 — vertigo and ataxia dependent upon, 63, 64, 65.
- Cerebral thermometry, 84.  
 — topography, its surgical bearings, 68.  
 Cerebro-spinal axis, 5.  
 — fluid, 292.  
 — fluid, its normal quantity and functions, 292, 293.  
 — fluid, its relation to consciousness, 45.  
 — nerves, 5-9.
- Cerebrum, its anatomy, functions, and clinical aspects, 25.  
 — caudate nucleus of, 48.  
 — centers of motion of, 28.  
 — construction of its gray matter, 75.
- Cerebrum, converging fibers of, 26.  
 — convolutions of (cut), 31.  
 — convulsions due to lesions of, 47.  
 — cortex of, its centers, 32.  
 — course of nerve impulses in (diagram), 53.  
 — effects of lesions of central portions of, 92.  
 — effects of lesion of cortex (general summary), 82.  
 — effects of lesions of internal capsule of, 91.  
 — effects of lesions of motor area of, 37, 38.  
 — effects of lesions of the white center of the hemispheres, 81.  
 — effects of removal of, 29.  
 — excitable regions of its cortex, 85.  
 — frontal lobes of, 35.  
 — functions of, 27.  
 — functions of frontal lobes of, 35.  
 — functions of special motor centers of, 40, 42.  
 — guides to basal ganglia of, 71.  
 — gyri of, 77, 78, 79.  
 — hæmorrhage of, its effects upon, 30.  
 — hemispheres of, functions of, 28.  
 — internal aspect of (cut), 25.  
 — internal capsule of, 26.  
 — irritability of, 28.  
 — irritative lesions of motor area of, 46.  
 — its basal ganglia, 26.  
 — its convolutions, 75.  
 — lenticular nucleus of, 48.  
 — lobes of, 76.  
 — lobules of, 76.  
 — lobules of, their situation, 79.  
 — motor regions of, 36.  
 — motor and sensory tracts of (cut), 35.  
 — occipital lobe of, its functions, 50.  
 — principal fissures of, 77.  
 — results of lesions of frontal lobe of, 35.  
 — sensory lesions of, 48.  
 — sensory regions of cortex of, 86.  
 — softening of, its effects, 30.  
 — special centers of motion of, 39.  
 — structure of convolutions of (cut), 33.  
 — sulci of, 76.  
 — temporo-sphenoidal lobes of, and their functions, 51.
- Cervical plexus of nerves, 364.  
 — deep branches of, 369.  
 — its situation, 368.

- Cervical plexus, superficial branches of, 366.  
 Cheek, hypertrophy of, its causes, 163.  
 Chorda tympani nerve, its relations to taste, 160.  
 Choreic movements, their clinical significance in connection with cerebral lesions, 91.  
 Choroiditis, its effect on vision, 143.  
 Ciliary muscle, its function and nerve distribution, 129, 132, 133.  
 Cilio-spinal center, 147, 301, 311, 351.  
 — its relations to focal lesions of cord, 343.  
 Claw-hand deformity, 330.  
 Cochlea, 204, 207.  
 Coitus, its relation to spinal disease, 347.  
 — its relation to small sciatic and pudic nerves, 466, 468.  
 Color blindness, 116.  
 Column of Burdach, sclerosis of, 315, 316.  
 Column of Goll, sclerosis of, 315, 316.  
 Column of Türk, sclerosis of, 315, 326.  
 Conjunctiva, its nervous supply, physiology of, 171.  
 Consciousness, its relation to brain lesions, 45.  
 Convulsions of cerebral origin, 47.  
 Cornea, ulceration of, its relations to fifth nerve, 170.  
 Corpora quadrigemina, effect of lesions, 91.  
 — their functions, 58.  
 Corpus striatum, 26.  
 — its functions, 54.  
 — subdivisions of, 26.  
 Corti, membrane of, 210.  
 — organ of, 201, 208, 209.  
 Cranial nerves, 9–95.  
 Cranium, surgical guides of, 68, 69, 70, 71.  
 Crural neuralgia, 450.  
 Crus cerebri, its functions, 59.
- Deaf-mutism, 220.  
 Defecation, center of, 311.  
 — its relations to focal lesions of the spinal cord, 345, 347, 352.  
 Deglutition, center of, 67.  
 — center of, reflex acts of, 233.  
 — effects of section of fifth nerve upon, 160.  
 — excitatory nerve of, 231.  
 — its relations to glosso-pharyngeal nerve, 223.  
 — its relation to the otic ganglion, 174.
- Deglutition, mechanism of, 226, 227, 228, 229, 230, 231, 232, 233.  
 — muscles connected with, 370.  
 — relations of hypo-glossal nerve to, 277.  
 — relations of spinal accessory nerve to, 264.  
 Diabetes, center of, 67.  
 Diaphragmatic tetanus, 376.  
 Digestive tract, effects of section of pneumogastric nerve upon, 251.  
 Diplopia, its clinical significance, 148, 149.  
 Duchenne's disease, 149–196, 234, 278, 279.  
 — its relations to tetanoid paralysis, 330.  
 Dyspnœa, its relations to focal lesions of the spinal cord, 344.
- Ear, external, 201.  
 — internal, 204.  
 — internal, fluids of, 205.  
 — middle, 201.  
 — relations of muscles of, to hearing, 187.  
 Earache, its diagnostic importance, 171.  
 — its relations to fifth nerve, 170.  
 Eighth nerve (see Nerve, Auditory), 198.  
 Eleventh nerve (see Nerve, Spinal Accessory), 259.  
 Embolism of brain, 34.  
 Epilepsy, spinal, 345.  
 Erection, center of, 311.  
 Eustachian tube, function of, 202.  
 — its clinical points of interest, 217, 218.  
 Eye, in facial paralysis, 190.  
 — its relations to facial diplegia, 197, 198.  
 Eyeball, center of movements of, 139.  
 — motions of, 135, 136, 137, 138, 139, 140.  
 Eyelid, effect of closure of, on lachrymal apparatus, 121.  
 — mechanism of its closure, 121.  
 Eyes, bilateral deviation of, in cerebral lesions, 40.  
 — oscillatory movements of, their clinical significance, 215.
- Face, in facial diplegia, 197.  
 — motor centers of, 42, 43.  
 — motor points of (cut), 282.  
 — paralysis of muscles of, 191, 192, 193, 194.  
 — relations of cervical plexus to expression of, 368.  
 — relation of facial nerve to expression of, 189.  
 — spasm of muscles of, 190, 191.

- Facial diplegia, 196, 197.  
 Facial nerve (see Nerve, Faecial), 177.  
 — function of chorda tympani branch of, 160.  
 Facial neuralgia, 161.  
 Fallopius, aqueduct of, 177, 182.  
 — aqueduct of, its relations to faecial paralysis, 193, 194.  
 Fascia of chest, nerve distribution of, 368.  
 — of forearm, its nerve supply, 388.  
 — of leg, its relation to cutaneous nerves, 474.  
 — its nervous supply, 447.  
 Fasciæ, nervous distribution to (general axiom), 12, 13.  
 Fibers of Remak, 9.  
 Fifth cranial nerve (see Nerve, Trigemini), 151.  
 First cranial nerve (see Nerve, Olfactory), 95.  
 Fissure, ealearine, of cerebrum, 80.  
 — ealoso-marginal, of cerebrum, 80.  
 — external parieto-occipital, its relations to the lambdoidal suture, 68.  
 — external parieto-occipital, its situation, 77.  
 — external parieto-occipital, surgical guide to, 71.  
 — internal parieto-occipital, of cerebrum, 80.  
 — of Rolando, 37, 42.  
 — guide to, 70, 72.  
 — its relation to the coronal suture, 68.  
 — its situation, 77.  
 — of Sylvius, guides to, 71, 72.  
 — its situation, 77.  
 — its surgical importance, 77.  
 Foot, its attitude in tibial paralysis, 485, 486.  
 Forearm, motor points of (cut), 417, 418.  
 Fourth cranial nerve (see Nerve, Trochlearis), 149.  
 Fremitus of fingers in paralytic dementia, 281.  
  
 Gait of locomotor ataxia, 321.  
 — of peroneal paralysis, 483, 484.  
 — of sciatic paralysis, 481.  
 — of tetanoid paraplegia, 330.  
 Ganglion, ciliary, 174, 175.  
 — jugular, 222.  
 — jugular, of pneumogastric, 239.  
 — lenticular, 174, 175.  
 — Meckel's, 174, 175, 183, 186.  
 — Meckel's, excision of, 173.  
 Ganglion, of Luschka, 372.  
 — of root of pneumogastric, 239.  
 — of trunk of pneumogastric, 239.  
 — ophthalmic, 174, 175.  
 — ophthalmic, its relation to sixth nerve, 176.  
 — otic, 174, 175, 183, 186.  
 — submaxillary, 174, 175.  
 — of Andersch, 222.  
 — of Gasser, 229.  
 Ganglia, basal, of cerebrum, 26.  
 — basal, of cerebrum, effects of destruction of, 56, 57.  
 — basal, of cerebrum, effects of lesions of, 81.  
 — basal, of cerebrum, their functions, 54.  
 — connected with fifth cranial nerve, 173, 174.  
 — of the brain, 19, 20.  
 — of the fifth nerve (table of), 175.  
 General axioms of nerve distribution, 11, 12, 13.  
 Genito-urinary center, 301, 311.  
 Glands, cervical, relations of their enlargement to fifth nerve, 170.  
 Globus hystericus, 254.  
 Glossoplegia, 278, 279.  
 Glottis, respiratory movements of, 264.  
 Gluteal paralysis, 461.  
 Gubler, line of, 183, 192.  
  
 Hair, sudden blanching of, 169.  
 Hand, its relation to paralysis of median nerve, 397.  
 — its relation to paralysis of musculospiral nerve, 415, 416.  
 — its relation to paralysis of ulnar nerve, 403, 404.  
 — motor centers of, 43.  
 — motor points of (cut), 417, 418.  
 Handwriting, its modifications in paralytic dementia, 281.  
 Head, nerve supply to posterior portion of, 366, 367.  
 Hearing, centers of, 86.  
 — effects of section of fifth nerve upon, 160.  
 — general view of organ of, 200.  
 — its relations to facial paralysis, 194.  
 — its relation to otic ganglion, 174.  
 — mechanism of, 202, 203, 204, 207, 208, 209, 210.  
 — relations of muscles of ear to, 187.

- Hearing, special centers of, 52.
- Heart, acceleratory center of, 342, 343, 344.  
 — effects of section of pneumogastric upon, 251.  
 — inhibitory center of, 67.
- Hemianopsia, its varieties and causes, 123, 124.
- Hemiparaplegia, 348, 352.
- Hemiplegia spinal, 348, 350.
- Hiccough, 374, 375.  
 — its relations to focal lesions of spinal cord, 343.
- Huguier, canal of, 182.
- Hypergeusia, its tests and clinical significance, 235.
- Hyperopia, its effects on health, 109, 110.
- Hyperosmia, its causes and tests, 102.
- Incoördination, theories of origin of, 325.
- Intercostal neuralgia, 430.
- Internal capsule of the brain, 26, 48.  
 — effects of lesions of, 44, 49, 91.
- Iris, its nervous supply and movements, 130, 131, 134, 135.  
 — reflex action of, and its clinical bearings, 135.  
 — relations of blood-vessels to movements, 134.
- Island of Reil, effects of lesions of, 86.  
 — its situation, 79, 80.
- Jacksonian epilepsy, 47.
- Kinesodic system, 313.
- Kopp's asthma, 254.
- Labyrinth, its anatomy and functions, 204.
- Lachrymal apparatus, its relation to facial paralysis, 198.
- Larynx, effects of section of pneumogastric nerve upon, 249.
- Lenticular nucleus, 48.
- Liver, effects of section of pneumogastric nerve upon, 252.
- Lobe, frontal, of cerebrum, 35.  
 — frontal, of cerebrum, fifth convolution of, in criminals, 77.  
 — frontal, of cerebrum, its convolutions or gyri, 78.  
 — occipital, of cerebrum, its convolutions or gyri, 79.  
 — occipital, of cerebrum, its functions, 50.
- Lobe, parietal, of the cerebrum, its convolutions or gyri, 78.
- Lobule, occipital, its situation, 80.  
 — para-central, 37.  
 — its situation, 80.
- Lobulus centralis, its situation, 79.  
 — quadratus, its situation, 80.
- Local tenderness of skin, significance of, 12.
- Locomotor ataxia, 316.
- Locus cæruleus, 175.
- Lower extremity, motor centers of, 40, 42.
- Lumbar plexus, 435, 436.  
 — tables of branches of, 437, 438.
- Lumbo-sacral cord, 458.
- Lungs, effect of section of pneumogastric nerve upon, 250.
- Macropsia, its clinical significance, 142, 143.
- Macula lutea, 105.
- Malum Cotunnii, 478.
- Mastication, effects of section of fifth nerve upon, 160.  
 — its alteration in Duchenne's disease, 279.
- Mastodynia, 432, 433.
- Meckel's ganglion, 174, 175.
- Median nerve, trophic effects of paralysis of, 398.
- Medulla oblongata, respiratory center of, its clinical relations, 342.  
 — centers of, and their functions, 66, 67.  
 — functions of, 65.  
 — nerve, nuclei of, 66.
- Megalopsia, its clinical significance, 142, 143.
- Menière's disease, 62, 120, 211.
- Meningo-encephalitis, 90.
- Meso-cephalon, motor and sensory tracts of (cut), 35.
- Micropsia, its clinical significance, 142, 143.
- Micturition, center of, 311.  
 — its relations to focal lesions of the spinal cord, 345, 347, 352.
- Monoplegia, surgical relief of, 74.  
 — traumatic and surgical aspects, 74.  
 — types of, 45, 46.
- Motor nerves, methods of termination (cut), 10.
- Motor oculi nerve, 127.  
 — its clinical relations, 142.  
 — its origin and course, 127, 128.  
 — its relations to the perception of distance, 140.

- Motor oculi nerve, physiology of its distribution, 131, 132, 133.  
 — symptoms of paralysis of, 145.  
 Motor points of upper extremity (cut), 415, 416, 417, 418.  
 Mouth, changes due to spasm of, 165.  
 — changes in Bell's paralysis, 180.  
 — motor centers of, 42.  
 Muscæ volitantes, their causes, 115.  
 Muscles, buccinator, its relations to deglutition, 227.  
 — buccinator, physiology of action, 188, 189.  
 — platysma, physiology of its action, 188.  
 — quadriceps extensor, spasm of, 448.  
 — stapedius, 181.  
 — stapedius, function of, 217.  
 — sterno-mastoid, its nerve supply, 266.  
 — sterno-mastoid, paralysis of, 270, 271.  
 — sterno-mastoid, tonic and clonic spasm of, 268, 269.  
 — tensor tympani, function of, 204, 217.  
 — tensor tympani, its relations to facial paralysis, 194.  
 — trapezius, its nerve supply, 266.  
 — trapezius, paralysis of, 271, 272.  
 — trapezius, tonic and clonic spasm of, 268, 269.  
 Muscles, causes of contracture after paralysis of, 346.  
 — extensor and adductor groups of thigh, spasm of, 482.  
 — flexor group of foot, spasms of, 482, 483.  
 — flexor group of leg, spasm of, 482.  
 — gluteal, paralysis of, 461, 462.  
 — gluteal, spasms of, 461.  
 — of the hip, spasm of, 452, 481.  
 — of the thigh, atrophy of, 450.  
 — of the thigh and leg, their physiological groupings, 454, 455.  
 — of voice, nervous supply of, 263.  
 Myelitis, central, of spinal cord, 338.  
 — of anterior horns of spinal cord, 331.  
 — polio-, 332.  
 Myopia, its effects, 109, 111.  
 Nerve, abducens, 175, 176.  
 — abducens, clinical relations of, 176, 177.  
 — abducens, functions of, 176, 177.  
 — accessory obturator, 437, 438.  
 Nerve, accessory obturator, its distributions and functions, 456, 457.  
 — anterior crural, 437, 438.  
 — anterior crural, its clinical relations, 447.  
 — anterior crural, its distributions and functions, 444, 445.  
 — anterior crural, its relations to joints, 444, 445.  
 — anterior interossecus, 382.  
 — anterior tibial, 472.  
 — Arnold's, 239.  
 — auditory, 198.  
 — auditory, anæsthesia of, 220.  
 — auditory, clinical points afforded by, 211.  
 — auditory, diagram of, 198.  
 — auditory, hyperæsthesia of, 219.  
 — auditory, its origin, 198.  
 — auditory, peculiarity of fibers of, 199.  
 — cardiac, 245.  
 — cervical, clinical points pertaining to, 372.  
 — cervico-facial, 179, 182, 188.  
 — chorda tympani, 182, 183, 234.  
 — chorda tympani, diagram of, 183, 185.  
 — chorda tympani, function of, 225.  
 — chorda tympani, its origin, 179.  
 — chorda tympani, its relations to facial paralysis, 193, 194.  
 — chorda tympani, its relation to the sub-maxillary gland, 174.  
 — chorda tympani, its relations to taste, 160.  
 — eiliary, 153, 154.  
 — circumflex, of arm, 378, 384, 406.  
 — circumflex, of arm, its clinical relations, 407.  
 — circumflex, of arm, its distribution and functions, 406, 407.  
 — cochlear, 200.  
 — communicans noni, 275, 276, 362, 364.  
 — communicans noni, its surgical relations, 369.  
 — compound, of the head, 172.  
 — eutaneous, of ear, 158.  
 — dental, inferior, 153, 154.  
 — depressor, of heart, 238, 239, 245, 263.  
 — depressor, of heart, its relations to spinal accessory nerve, 265.  
 — descendens noni, 275, 276.  
 — dorsal, of penis, 459.

- Nerve, dorsal, of penis, its distributions and functions, 467, 468.
- efferent, 7.
- excitory, of deglutition, 231.
- external anterior thoracic, 378, 382, 385.
- external cutaneous, of the arm, 378, 382, 385.
- external cutaneous, of the thigh, 437, 438.
- external cutaneous, of thigh, its distribution and functions, 442, 443.
- external popliteal, 459, 472.
- external respiratory, of Bell, 378.
- external saphenous, 472.
- facial, 177.
- facial, clinical points afforded by, 190.
- facial, communications of, 178, 179.
- facial, course of, 177.
- facial, diagram of, 179.
- facial, functions of, 179, 180.
- facial, lingual branch of, 182, 184.
- facial, its relations to Duchenne's disease, 280.
- facial, origins of, 177.
- facial, paralysis of, 180.
- facial, relations to fifth nerve, 183.
- facial, table of branches of, 182.
- fibers (cut), 5.
- frontal, 153, 154.
- genito-crural, 437, 438.
- genito-crural, its distribution and clinical relations, 443, 444.
- glosso-pharyngeal, 220.
- glosso-pharyngeal, clinical points of interest of, 234.
- glosso-pharyngeal, effects of section of, 225.
- glosso-pharyngeal, its origin and relations, 221.
- glosso-pharyngeal, table of branches of, 225.
- great auricular, 362, 363, 364, 366, 367.
- great occipital, 362, 363, 366, 367.
- great sciatic, 458, 459.
- great splanchnic, its relation to pain, 426.
- gustatory, 153, 154.
- hypo-glossal, 272.
- hypo-glossal, clinical points pertaining to, 277.
- Nerve, hypo-glossal, communications of, 273, 274, 275.
- hypo-glossal, effects of section of, 277.
- hypo-glossal, general function of, 272, 276.
- hypo-glossal, its relations to deglutition, 227, 228, 277.
- hypo-glossal, origin of, 272, 273.
- ilio-hypogastric, 437, 438.
- ilio-hypogastric, its clinical relations, 440.
- ilio-hypogastric, its distributions and functions, 439, 440.
- ilio-inguinal, 437, 438.
- ilio-inguinal, its clinical relations, 440.
- ilio-inguinal, its distribution and functions, 439, 440.
- inferior dental, rules for section of, 173.
- inferior gluteal, 459.
- inferior hemorrhoidal, 459.
- inferior hemorrhoidal, its distributions and functions, 467, 468.
- inferior maxillary, 153, 154.
- inferior pudendal, 459.
- inhibitory, of vaso-motor center, 247.
- intercostal, physiology of, 421, 422, 423, 424.
- internal anterior thoracic, 378, 383, 385.
- internal cutaneous, of arm, 378, 383, 398.
- internal cutaneous, of the thigh, 438.
- internal popliteal, 459, 472.
- internal saphenous, 438.
- Jacobson's, 225.
- lachrymal, 153, 154.
- laryngeal, 242, 243.
- lesser internal cutaneous, 378, 383, 398.
- long saphenous, 438.
- long saphenous, its distribution and physiology, 447.
- median, 378, 382, 391.
- median, its clinical relations, 395.
- median, its distribution and functions, 393, 395.
- median, its surgical relations, 393, 398.
- middle cutaneous, of the thigh, 438.
- motor-oculi, 127.
- motor-oculi externus, 175, 176.
- muscular, of brachial plexus, 378.
- musculo-cutaneous, 382, 385.

- Nerve, musculo-cutaneous, of arm, its clinical relations, 390, 391.
- musculo-cutaneous, of arm, its physiological relations, 386, 387, 388.
- musculo-cutaneous, of leg, 472.
- musculo-spiral, 378, 384, 408.
- musculo-spiral, its clinical relations, 412.
- musculo-spiral, its course and distribution, 408.
- musculo-spiral, its cutaneous distribution, 411, 412.
- mylo-hyoid, 153, 154.
- nasal, 153, 154.
- obturator, 437, 438.
- obturator, its clinical relations, 455.
- obturator, its distributions and functions, 452, 453, 454.
- olfactory, 95.
- olfactory, distribution and functions in animals, 98.
- olfactory, its clinical relations, 101.
- olfactory, its origin, 95, 96.
- olfactory, its relation to reflex action, 100.
- olfactory, structure of filaments of, 97.
- ophthalmic, 153, 154.
- optic, 103.
- optic, causes of impairment of its fibers, 123, 124, 125, 126, 127.
- optic, chiasm of, 103.
- optic, distribution of, 105.
- optic, fibers of, 103, 104.
- optic, its association with fifth nerve, 106.
- optic, its clinical relations, 122.
- optic, its effect on coördination of movement, 120.
- optic, its effect on lachrymal apparatus, 120.
- optic, its effect on the pupil, 106.
- optic, its relations in the orbit, 108.
- optic, its relations to blood-vessels, 103, 109.
- optic, its clinical relations to intracerebral pressure, 123.
- optic, its relations to reflex action, 106.
- optic, physiological reasons for peculiar distribution of its fibers, 107, 108.
- orbital, 153, 154.
- of Wrisberg, 199, 378, 383, 424.
- patheticus, 149.
- Nerve, perineal, 459.
- perineal, its distributions and functions, 467, 468.
- peroneal, 472.
- phrenic, 362, 364, 378.
- phrenic, disorders of, 374.
- phrenic, its relations to focal lesion of spinal cord, 342.
- phrenic, its surgical relations and functions, 370.
- phrenic, physiology of distribution of, 370, 371, 372.
- pneumogastric, 236.
- pneumogastric, afferent fibers of, 247.
- pneumogastric, anastomoses of, 237.
- pneumogastric, branches of, 240.
- pneumogastric, clinical points pertaining to, 253.
- pneumogastric, course and relations of, 248, 249.
- pneumogastric, diagram of, 238, 241.
- pneumogastric, effects of section of, 249, 250, 251, 252.
- pneumogastric, efferent fibers of, 240.
- pneumogastric, functions of, 240.
- pneumogastric, its relations to Duchenne's disease, 280.
- pneumogastric, relations to respiration, 247.
- portio intermedia, 179.
- posterior interosseous, 384, 410.
- posterior thoracic, 378.
- posterior tibial, 472.
- pudic, 458, 459.
- pudic, its clinical relations, 468.
- pudic, its distributions and functions, 467, 468.
- pudic, its relations to the urinary organs and coitus, 468, 469.
- pulmonary, their clinical relations, 255.
- radial, 384, 410.
- recurrent laryngeal, 239.
- sciatic, its clinical relations and those of its branches, 478.
- sciatic, its distributions and functions, 469, 470, 471.
- sciatic, paralysis of, or of its branches, 483, 484.
- small occipital, 362, 363, 364, 366, 367.
- small sciatic, 458, 459.
- small sciatic, its distribution and function, 464.



- Nerve, small sciatic, its relation to coitus, 465, 466.
- small sciatic, its relations to genital organs, 466.
- sphenopalatine, 153, 154.
- spinal accessory, 259.
- spinal accessory, clinical points pertaining to, 268.
- spinal accessory, communications of, 260.
- spinal accessory, distribution of, 261.
- spinal accessory, effects of extirpation of, 265.
- spinal accessory, its communication with the suboccipital nerve, and its physiological importance, 267.
- spinal accessory, its distribution to muscles, and its physiological importance, 266.
- spinal accessory, its relations to deglutition, 264.
- spinal accessory, its relations to Duchenne's disease, 280.
- spinal accessory, its relations to the heart's action, 264.
- spinal accessory, its relations to singing, 266.
- spinal accessory, its relation to voice, 264.
- sublingual, 272.
- suboccipital, 362, 366.
- subscapular, 378, 384, 404.
- supra-clavicular, 362, 363.
- superficial cervical, 362, 363, 364.
- superficial perineal, 459.
- superior gluteal, 458, 459.
- superior gluteal, its clinical relations, 460, 461.
- superior gluteal, its distribution and functions, 459, 460.
- superior maxillary, 153, 154.
- superior respiratory, of Bell, 243.
- sympathetic, 7.
- sympathetic, communications of, 9.
- sympathetic, distribution of, 7.
- sympathetic, function of, 7.
- sympathetic (cuts), 6-8.
- temporal, deep, 153, 157.
- temporo-facial, 179, 182, 188.
- temporo-malar, 153, 154.
- thoracic, 385.
- trigeminus, 151.
- trigeminus, afferent fibers of, 157.
- Nerve, trigeminus, clinical points afforded by, 161.
- trigeminus, diagnostic value of, 169.
- trigeminus, diagram of, 154.
- trigeminus, effects of section of, 159.
- trigeminus, efferent fibers of, 155.
- trigeminus, function of its efferent fibers, 155, 156.
- trigeminus, ganglia connected with, 173.
- trigeminus, its relations to deglutition, 228.
- trigeminus, its motor and sensory root, 152.
- trigeminus, its origin, 151.
- trigeminus, neuralgias of, 161, 162, 163.
- trigeminus, paralysis of, 165, 166, 167, 168, 169.
- trigeminus, spasms due to, 164.
- trigeminus, surgical anatomy of, 172.
- trigeminus, table of branches of, 153.
- trochlear, 149.
- trochlear, effect of paralysis of, 150, 151.
- trochlear, its origin and function, 149, 150.
- tympanic, 179, 182.
- ulnar, 378, 383, 400.
- ulnar, its clinical relations, 402.
- ulnar, its distribution, 400, 402.
- ulnar, its relations to focal lesions of cord, 344.
- ulnar, its surgical relations, 400.
- vestibular, 200.
- Vidian, 182, 183, 186.
- Nerves, afferent, 7.
- auriculo-temporal, 153, 154.
- brachial plexus of, 378.
- cranial, 9-95.
- cardiac, their clinical relations, 256.
- cardiac functions of, 245, 246.
- cerebro-spinal, 5-9.
- cervical, 355.
- cervical (lower), 378.
- cervical, classification of branches, 362.
- cervical plexus of, 364.
- coccygeal, 356.
- cutaneous, clinical guides to, 158, 159.
- cutaneous, of abdomen, their clinical subdivisions, 440.
- cutaneous, of head, 157, 158, 159.
- dental, anterior and posterior, 153, 154.

- Nerves, dorsal, 355, 419, 420.  
 — dorsal, their clinical relations, 424.  
 — dorsal, their communication with the sympathetic nerve, 419.  
 — dorsal, their relation to the brachial plexus, 419.  
 — dorsal, their relation to the contents of the mediastinæ of the chest, 425.  
 — dorsal, their relation to heart disease, 424.  
 — dorsal, their relation to pleurisy, 424.  
 — dorsal, paralysis of, 433, 434, 435.  
 — dorso-lumbar, 422.  
 — from lower cervical region, 377.  
 — gastric, their clinical relations, 257.  
 — general axioms of, 11, 12, 13.  
 — hepatic of pneumogastric, their clinical relations, 258.  
 — intercostal, 420.  
 — intercostal, lateral and anterior cutaneous branches of, 420.  
 — intercostal, neuralgia of, 430, 431, 432.  
 — intercostal, their relation to abdominal pain, 427, 428.  
 — intercostal, their relation to disease of the digestive viscera, 426.  
 — intercostal, their relation to disease of the stomach, 426.  
 — intercostal, their relations to focal lesions of spinal cord, 351.  
 — intercostal, their relations to the pleura, 422.  
 — intestinal, of pneumogastric, their clinical relations, 258.  
 — laryngeal, their clinical relations, 254.  
 — law of distribution of, 10.  
 — lumbar, 355, 436.  
 — motor, methods of termination (cut), 10.  
 — motor points of, on skin, 3.  
 — œsophageal, 251.  
 — of arm and forearm (tables of), 382.  
 — of hip joint, 477, 478.  
 — of larynx, 243, 244.  
 — of leg and foot (table of), 472.  
 — of respiratory movements of glottis, 243.  
 — petrosal, 179, 182, 183, 184, 186.  
 — petrosal, diagram of, 186.  
 — petrosal, their relations to facial paralysis, 193, 194.  
 — plantar, 472.  
 — practical interest of, 3.
- Nerves, resection of, rules for, 172.  
 — respiratory, of Bell, 187.  
 — sacral, 355, 457.  
 — sacral, neuralgia of posterior branches of, 480.  
 — spinal, 9-292.  
 — spinal, axioms of distribution of, 358, 359, 360.  
 — spinal, roots of, 9.  
 — subscapular, distribution of each, 404.  
 — subscapular, their clinical relations, 405, 406.  
 — superior maxillary, rules for excision of, 173.  
 — supra-orbital, 153, 154.  
 — supra-orbital, rules for division of, 172, 173.  
 — supra-scapular, 378.  
 — thoracic intercostal, 420.  
 — thoracico-abdominal intercostal, 420.  
 — to the peritonæum, and their physiology, 441.  
 — trochlear, 153, 154.  
 — vaso-motor for trunk, extremity, and viscera, 310.  
 — vaso-motor of spinal cord, 310.
- Nervous system of man, general arrangement of, 5.
- Neuralgia, cervico-occipital, 373.  
 — diaphragmatic, 374.  
 — intercostal, 430, 431, 432.  
 — of anterior crural nerve, 450.  
 — of the ilio-hypogastric and ilio-inguinal nerves, 439, 440.  
 — of the mammary gland, 432.  
 — of the obturator nerve, 455.  
 — of the phrenic nerve, 374.  
 — of the phrenic nerve, its differential diagnosis, 375.  
 — of the sciatic nerve, 478, 479, 480, 481.
- Ninth nerve, 220.
- Nucleus caudatus, guide to, 71.
- Nystagmus, its clinical significance, 146.
- Obturator neuralgia, 455, 456.  
 — paralysis, 456.
- Ocular movements, center of, 40, 52, 58.
- Œsophagus, center of movement of, 67.
- Olfactory nerve. (See Nerve, Olfactory.)
- Optic nerve. (See Nerve, Optic.)
- Optic thalamus, 26, 48.  
 — guide to, 71.

- Optic thalamus, its effects on vision, 57.  
 — its functions, 54.
- Pain, at knee joint, its clinical significance, 448, 454, 474, 475, 476.  
 — facial, of Fothergill, 161.  
 — general clinical significance of, 13.  
 — in the back, its relation to aneurism, 427.  
 — in the pectoral region, its clinical significance, 427.  
 — in the penis, its clinical significance, 466.  
 — in the pit of the stomach, its clinical significance, 426.  
 — in the region of the thorax, its diagnostic value, 424, 425, 426.  
 — in the shoulder, its relation to diseases of the liver, 428.  
 — in the thorax, its relation to gastric and intestinal disease and tumors of the viscera, 428.  
 — its relation to brain lesions, 45.  
 — its relation to the phrenic nerve, 371.  
 — of gout, 318.  
 — of locomotor ataxia, its diagnostic peculiarities, 317.  
 — of rheumatism of muscles, 319.  
 — superficial, clinical significance of, 11.
- Palate, its relation to deglutition, 231.  
 — its relations to facial paralysis, 194.  
 — its relations to glosso-pharyngeal nerve, 222.  
 — nerves of, 185.
- Papilla of retina, 105.
- Para-central lobule, effect of lesions of, 44.
- Paralysis, atrophic spinal, 331.  
 — bilateral, of face, 196.  
 — bulbar, 278, 279.  
 — cerebral, surgical relief of, 73, 74.  
 — crossed, 177, 182, 192.  
 — crossed, diagram of, 60.  
 — crossed, its varieties, 59.  
 — due to crutches, 419.  
 — due to lead poisoning, 413, 414, 415.  
 — facial, 191, 192, 193, 194.  
 — facial crossed, 182, 183, 184, 192, 193.  
 — general, of the insane, 90.  
 — glosso-labio-laryngeal, 234, 278, 279.  
 — motor, due to lesions of cortex, 44.  
 — motor, its clinical significance when occurring on the same side as an injury to the head, 73.  
 — of anterior crural nerve, 449, 450.
- Paralysis, of Bell, 180, 181.  
 — of circumflex nerve of shoulder, 407, 408.  
 — of cranial nerves following injury to the head, 73.  
 — of diaphragm, 374, 376.  
 — of dorsal nerves, 433, 434, 435.  
 — of Duchenne, 198, 278, 279.  
 — of facial muscles, 88.  
 — of facial nerve, its relation to hemiplegia, 59.  
 — of the insane, 281.  
 — of lower extremity, 88.  
 — of median nerve, 395, 396, 397.  
 — of muscles of the back, 434, 435, 436.  
 — of musculo-cutaneous nerve, 390.  
 — of musculo-spiral nerve, 412, 413, 414, 415, 416.  
 — of obturator nerve, 455, 456.  
 — of ocular muscles, its causes, 147, 148.  
 — of the ocular muscles, its effect on the position of the head, 140, 141, 142.  
 — of peroneal nerve, 483.  
 — of sciatic nerve, 481, 483.  
 — of sciatic nerve, its sensory disturbances, 486.  
 — of sciatic nerve, its trophic disturbances, 486.  
 — of superior gluteal nerve, 461.  
 — of ulnar nerve, 402, 403, 404.  
 — spastic spinal, 329.  
 — of tibial nerve, 484, 485.  
 — of tongue, 283.  
 — of upper extremity, 88.  
 — tetanoid, 329.  
 — tetanoid, gait of, 330.  
 — tetanoid, its relations to Duchenne's disease, 330.
- Paralytic dementia, 281.
- Paralyzed muscles, early rigidity of, in cortical lesions of the brain, 45.  
 — late rigidity of, 44.  
 — late rigidity of, its causes, 89.  
 — theories of late rigidity of, 48.
- Paraplegia, hemi-, 348, 352.  
 — tetanoid, 329.
- Parturition, center of, 311.
- Patheticus nerve, 149.
- Pleurodynia, its diagnosis from pleurisy and angina pectoris, 432.
- Point apophysaire, 163.
- Polio-myelitis, its causes, varieties, and symptoms, 332, 333, 334.

- Polydipsia, its clinical significance, 257.  
 Polyphagia, its clinical significance, 258.  
 Pons Varolii, its functions, 59, 61.  
 Progressive muscular atrophy, 334.  
 Prosopalgia, its clinical significance, 161.  
 Ptosis, 145.  
 Puncta dolorosa, of cervico-occipital neuralgia, 373.  
 — of crural nerve, 450.  
 — of fifth nerve, 163.  
 — of intercostal nerve, 432.  
 — of lumbar nerves, 440.  
 — of phrenic neuralgia, 374.  
 — of sciatic nerve, 480.  
 Pupil, changes in and their physiology, 114.  
 — mechanism of its contraction and dilatation, 130, 131, 134, 135.
- Remak, fibers of, 9.  
 Respiration, center of, 342.  
 Retina, blind spot of, 115.  
 — construction of, 117.  
 — papilla of, 165.  
 Rolando, fissure of, 37, 42.  
 Roots of spinal nerves, 9.
- Saccule of the labyrinth, 200, 206.  
 Sacral plexus, 457.  
 — articular branches of, 453, 459.  
 — muscular branches of, 458, 459.  
 — muscular branches of, their distribution and function, 462, 463, 464.  
 — table of its branches, 458.  
 Salaam convulsions of Newnham, 270.  
 Salivary secretion, center of, 67.  
 — effects of section of fifth nerve upon, 160.  
 Scalp, pain of, its diagnostic importance, 171.  
 Sciatic neuralgia, 478, 479, 480, 481.  
 Second cranial nerve, 103.  
 Sensory impressions, perception of, 48.  
 Seventh cranial nerve (see Nerve, Facial), 177.  
 Sight, center of, 50, 51, 52.  
 — effects of section of fifth nerve upon, 160.  
 Singing, its alteration in Duchenne's disease, 280.  
 — relations of spinal accessory nerve to, 266.  
 Sixth cranial nerve (see Nerve, Abducens), 175.  
 Skin, nervous distribution to (general axiom), 12.
- Smell, effect of fifth nerve upon, 98.  
 — effects of section of fifth nerve upon, 160.  
 — its modifications and their causes, 99.  
 — its alterations in Bell's paralysis, 102.  
 — its modifications in animals and races, 98.  
 — its relations to taste, 101.  
 — physiology of its production, 98.  
 — relations of act of sniffing to, 187.  
 — relations of the facial nerve to, 187.  
 — special centers of, 52, 53.  
 — tests for, 101, 102.  
 Sneezing, its physiology, 99.  
 Sömmering, yellow spot of, 105.  
 Spasm of diaphragm, due to phrenic nerve, 374, 376.  
 — of gluteal muscles, 461.  
 — of lower limbs, 481.  
 — of muscles of the hip, 452.  
 — of quadriceps extensor muscle, 448.  
 — of sterno-mastoid and trapezius muscles, 269, 270.  
 — of tongue, 283.  
 Spasmodic contraction of the hip, 481.  
 — tabes, 329.  
 Speech, center of, 32, 86.  
 — its alterations in Duchenne's disease, 279.  
 — its modifications in paralytic dementia, 281.  
 — muscles connected with, 370.  
 Spina bifida, its clinical relations to nerve centers, 292.  
 Spinal cord, 287, 288.  
 — an organ of conduction, 299.  
 — anterior and posterior root zones of, 297.  
 — anterior fundamental column of, 297.  
 — antero-lateral columns of, 298, 300.  
 — appearance of transverse section of, 294.  
 — arrangement of its sensory fibers, 304.  
 — arrangement of motor fibers of, 302.  
 — as a nerve center, 309.  
 — automatic action of, 304, 312.  
 — æsthesodic system of, 313.  
 — central canal of, 295, 306.  
 — central myelitis of, 338.  
 — classification of diseases of, 315.  
 — clinical points pertaining to, 313.  
 — columns of, 290, 291.  
 — columns of Goll and Burdach, 297, 309.

- Spinal cord, columns of Goll, Türek, Burdach, their physiology, 297, 298, 309.
- commissural fibers of, 301, 307, 309.
  - commissures of, 290, 296.
  - construction of anterior horns of, 294.
  - decussation of sensory and motor fibers of, 307, 308.
  - degeneration of the cells of anterior horns of, 334.
  - direct cerebellar column of, 298.
  - direct and crossed pyramidal columns of, 297.
  - excitability of, 300, 301.
  - fissures of, 290.
  - fibers of, general proportions of, 309.
  - focal lesions of, 339.
  - focal lesions of, above lumbar enlargement, 346.
  - focal lesions at lumbar enlargement of, 347.
  - focal lesions of, cervical enlargement of, 342.
  - focal lesions of lateral half of, 348.
  - focal lesions of mid-dorsal region of, 345.
  - focal lesions of upper cervical regions of, 342.
  - functions of, 299.
  - functions of its gray matter, 300.
  - general construction of, 289.
  - gray substance of, component parts of, 295.
  - its gray and white matter, 294, 295.
  - its investing fluid, 292.
  - kinesodic system of, 313.
  - membranes of, 292.
  - myelitis of anterior horn, 331.
  - nerves arising from, 291.
  - nerve cells of, 302, 303, 304, 305.
  - non-systematic or focal lesions of, 314, 315, 339.
  - paths of motor and sensory impulses in, 299, 300.
  - reflex action of, 310.
  - sclerosis of, lateral columns of, 329.
  - special centers of, 301.
  - systematic lesions of, 313, 315.
  - systematic lesions of, æsthesodic system of, 315.
  - systematic lesions of, kinesodic system of, 325.
  - trophic function of, 301.
- Spinal cord, white substance of, component parts of, 295.
- varieties of fibers in, 302.
  - vaso-motor centers of, 310, 311, 351.
  - epilepsy, 345.
  - hemiplegia, 348, 350.
- Spinal nerves, 9, 355.
- nerves, roots of, 9, 355, 357.
  - paralysis, atrophic, 331.
- Stomach, center of movement of, 67.
- effects of section of pneumogastric upon, 252.
- Strabismus, internal, its clinical significance, 146, 149, 176.
- Suture, coronal, its relation to the fissure of Rolando, 68.
- lambdoidal, its relation to the external parieto-occipital fissure of the cerebrum, 68.
- Sympathetic nerve, 7.
- communications of, 9.
  - distribution of, 7.
  - function of, 7.
  - cuts of, 6-8.
- Tactile sensation, destruction of, 49.
- Taste, anæsthesia of, 236.
- effect of chorda-tympani nerve on, 160.
  - effects of nerves upon, 225.
  - effects of section of fifth nerve upon, 160.
  - hyperæsthesia of, 235.
  - its clinical relations, 235.
  - its relations to facial paralysis, 193.
  - its relations to glosso-pharyngeal nerve, 224.
  - limits of its situation, 226.
  - buds, 225, 226.
- Teeth, chattering of, in spasm, 164.
- grinding of, in spasm, 164.
- Temperature of the body, its relations to focal lesions of the cord, 344.
- Tendo oculi, its function, 121.
- Tenth cranial nerve (see Nerve, Pneumogastric), 236.
- Tetanoid paraplegia, 329.
- Third cranial nerve (see Nerve, Motoroculi), 127.
- Tic-douloureux, 161.
- Tongue, fibrillary tremor of, 283.
- furring of, its clinical significance, 170, 224.

- Tongue, its relations to deglutition, 227, 229.  
 — nerves of, 276, 277.  
 — paralysis of, 283.  
 — spasm of, 283.  
 Trephining, surgical rules for, 73.  
 Trigemius nerve. (See Nerve, Trigemius.)  
 Trochlear nerve, 149.  
 — effect of paralysis of, 150, 151.  
 — its origin and function, 149, 150.  
 Tumors, cerebral, their symptoms, 164.  
 Twelfth cranial nerve (see Nerve, Hypoglossal), 272.
- Upper extremity, motor centers of, 42.  
 Utricle, 206.
- Vaso-motor fibers of fifth nerve, 163.  
 Vestibule of labyrinth, 200, 204.  
 Vision, accommodation of, 132.
- Vision, centers of, 86.  
 — colored perceptions of objects, 50, 51.  
 — contraction of the field of, 49.  
 — deceptive, its clinical significance, 142.  
 — determination of distance, 140.  
 — its abnormalities and their consequences, 109, 110.  
 — perception of color, 116, 118, 119.  
 — physiology of light sensations, 115.  
 — tests for, 112, 113.  
 Visual purple, 116.  
 Voice, its relations to facial diplegia, 197.  
 — nervous supply of muscles of, 263.  
 — relations of spinal accessory nerve to, 264.  
 Vomiting, center of, 67.  
 — nervous, 258.
- Wrisberg, nerve of, 177, 179.

THE END.

# MEDICAL AND HYGIENIC WORKS

PUBLISHED BY

D. APPLETON & CO., 1, 3, & 5 Bond St., New York.

	PRICE
ALCOHOL: ITS USE AND ABUSE. Health Primers. 16mo....Cl.,	\$0 40
ANSTIE (FRANCIS E.) Neuralgia and Diseases which resemble it. By Francis E. Anstie, M. D., F. R. C. P., Senior Assistant Physician to Westminster Hospital; Lecturer on Materia Medica in Westminster Hospital School; and Physician to the Belgrave Hospital for Children; editor of "The Practitioner" (London), etc. 12mo. Cloth,	2 50*
BARKER (FORDYCE). On Sea-Sickness. A Popular Treatise for Travelers and the General Reader. By Fordyce Barker, M. D., Clinical Professor of Midwifery and Diseases of Women in the Bellevue Hospital Medical College, etc. Small 12mo.... ..Cloth,	75
—— On Puerperal Disease. Clinical Lectures delivered at Bellevue Hospital. A Course of Lectures valuable alike to the Student and the Practitioner. Third edition. 8vo.....Cloth, \$5.00*; Sheep,	6 00*
BARNES (ROBERT). Lectures on Obstetric Operations, including the Treatment of Hæmorrhage, and forming a Guide to the Management of Difficult Labor. By Robert Barnes, M. D., F. R. C. P., Fellow and late Examiner in Midwifery at the Royal College of Physicians; Examiner in Midwifery at the Royal College of Surgeons, London. 8vo. Third edition, revised and extended. Illustrated..... ..Cloth,	4 50*
BARTHOLOW'S Treatise on Materia Medica and Therapeutics. A new and revised edition. By Roberts Bartholow, M. A., M. D., Professor of Materia Medica and Therapeutics in the Jefferson Medical College; late Professor of the Theory and Practice of Medicine, and of Clinical Medicine, and formerly Professor of Materia Medica and Therapeutics, in the Medical College of Ohio. <b>Revised edition of 1879.</b> 1 vol., 8vo. 548 pages..... ..Cloth, \$5.00*; Sheep,	6 00*
—— A New and Practical Treatise on the Principles and Practice of Medicine. 8vo. <b>Second edition, revised and enlarged.</b> Cloth, \$5.00*; Sheep,	6 00*
—— On the Antagonism between Medicines and between Remedies and Diseases. Being the Cartwright Lectures for the Year 1880. 8vo.... ..Cloth,	1 25*
BASTIAN (H. CHARLTON, M. D., F. R. S.) On Paralysis from Brain-Disease in its Common Forms. 12mo..... ..Cloth,	1 75*
—— The Brain as an Organ of the Mind..... ..	2 50
BATHS AND BATHING. Health Primers. 16mo..... ..Cloth,	40
BELLEVUE AND CHARITY HOSPITAL REPORTS. Edited by Prof. W. A. Hammond, M. D. 8vo..... ..	4 00*
BENNET (J. H.) Winter and Spring on the Shores of the Mediterranean; or, The Riviera, Mentone, Italy, Corsica, Sicily, Algeria, Spain, and Biarritz, as Winter Climates. By J. Henry Bennet, M. D., Member of the Royal College of Physicians, London. With numerous Illustrations. 12mo. New revised edition. ....Cloth,	3 50*
—— On the Treatment of Pulmonary Consumption, by Hygiene, Climate, and Medicine. Thin 8vo..... ..Cloth,	1 50*

	PRICE
BILLROTH (Dr. THEODOR). General Surgical Pathology and Therapeutics. A Text-book for Students and Physicians. By Dr. Theodor Billroth, Professor of Surgery in Vienna. From the eighth German edition, by special permission of the author, by Charles E. Hackley, M. D., Surgeon to the New York Eye and Ear Infirmary; Physician to the New York Hospital. <b>Fourth American edition, revised and enlarged.</b> 1 vol., 8vo.....Cloth, \$5.00*; Sheep, \$6 00*	\$6 00*
BUCK (GURDON). Contributions to Reparative Surgery, showing its Application to the Treatment of Deformities produced by Destructive Disease or Injury; Congenital Defects from Arrest or Excess of Development; and Cicatricial Contractions following Burns. Illustrated by Thirty Cases and fine Engravings. 8vo.....Cloth,	3 00*
CARPENTER (W. B.) Principles of Mental Physiology, with their Application to the Training and Discipline of the Mind, and the Study of its Morbid Conditions. By William B. Carpenter, M. D., LL. D., F. R. S., F. L. S., F. G. S., Registrar of the University of London, etc. 12mo.....Cloth,	3 00
CHAUVEAU (A.) The Comparative Anatomy of the Domesticated Animals. Translated and edited by George Fleming. 8vo. Illustrated.....Cloth,	6 00
COMBE (ANDREW). The Management of Infancy, Physiological and Moral. By Andrew Combe, M. D. Revised and edited by Sir James Clark, Bart., K. C. B., M. D., F. R. S. 12mo.....Cloth,	1 50
COOLEY'S Cyclopædia of Practical Receipts. A Comprehensive Supplement to the Pharmacopœia, etc. Sixth edition. Revised and partly rewritten. By Richard V. Tuson, Professor of Chemistry. Two volumes. 8vo. Illustrated.....Cloth,	9 00
CORFIELD (W H.) Health. 12mo.....Cloth,	1 25
DAVIS (HENRY G.) Conservative Surgery. With Illustrations. 8vo.....Cloth,	3 00*
ECKER (ALEXANDER). Convolutions of the Brain. Translated from the German by Robert T. Edes, M. D. 8vo.....Cloth,	1 25*
ELLIOT (GEORGE T.) Obstetric Clinic: A Practical Contribution to the Study of Obstetrics, and the Diseases of Women and Children. By George T. Elliot, Jr., A. M., M. D. 8vo.....Cloth,	4 50*
EXERCISE AND TRAINING. Health Primers. 16mo.....Cloth,	40
FLINT'S Manual of Chemical Examinations of the Urine in Disease; with Brief Directions for the Examination of the most Common Varieties of Urinary Calculi. By Austin Flint, Jr., M. D. Revised edition.....Cloth,	1 00*
— Physiology of Man. Designed to represent the existing state of Physiological Science as applied to the Functions of the Human Body. By Austin Flint, Jr., M. D., Professor of Physiology and Microscopy in the Bellevue Hospital Medical College, New York; Fellow of the New York Academy of Medicine; Member of the Medical Society of the County of New York; Resident Member of the Lyceum of Natural History in the City of New York, etc. Complete in 5 vols.	
Vol. 1. Introduction; The Blood; Circulation; Respiration. 8vo.	
Vol. 2. Alimentation; Digestion; Absorption; Lymph, and Chyle. 8vo.	
Vol. 3. Secretion; Excretion; Ductless Glands; Nutrition; Animal Heat; Movements; Voice and Speech. 8vo.	
Vol. 4. The Nervous System. 8vo.	
Vol. 5. (With a General Index to the five volumes.) Special Senses; Generation. Per vol... Cloth, \$4.50*; Sheep, 5 50*	5 50*
The five vols.....Cloth, \$22.00*; Sheep,	27 00*



	PRICE
FLINT'S Text-Book of Human Physiology; designed for the Use of Practitioners and Students of Medicine. Illustrated by three Lithographic Plates, and three hundred and thirteen Woodcuts. <b>Third edition, revised.</b> 1 vol., imperial 8vo. . . . Cloth, \$6.00*; Sheep, \$7 00*	
—— The Physiological Effects of Severe and Protracted Muscular Exercise; with Special Reference to its Influence upon the Excretion of Nitrogen. By Austin Flint, Jr., M. D., etc. 12mo. . . . Cloth, 1 00	
—— The Source of Muscular Power. Arguments and Conclusions drawn from Observation upon the Human Subject under Conditions of Rest and of Muscular Exercise. 12mo. . . . . 1 00	
FOURNIER (ALFRED, M. D.) Syphilis and Marriage. Translated by P. Albert Morrow, M. D. 8vo. . . . . Cloth, \$2.00*; Sheep, 3 00*	
FREY (HEINRICH). The Histology and Histochemistry of Man. A Treatise on the Elements of Composition and Structure of the Human Body. By Heinrich Frey, Professor of Medicine in Zurich. Translated from the fourth German edition, by Arthur E. J. Barker, Surgeon to the City of Dublin Hospital; Demonstrator of Anatomy, Royal College of Surgeons, Ireland; Visiting Surgeon, Convalescent Home, Stillorgan; and revised by the author. With 608 Engravings on Wood. 8vo. . . . . Cloth, \$5.00*; Sheep, 6 00*	
GAMGEE (JOHN). Yellow Fever a Nautical Disease. Its Origin and Prevention. 1 vol., 8vo. . . . . Cloth, 1 50	
GROSS (SAMUEL W., M. D.) A Practical Treatise on Tumors of the Mammary Gland. 8vo. Illustrated. . . . . 2 50*	
GUTMAN (EDWARD, M. D.) The Watering-Places and Mineral Springs of Germany, Austria, and Switzerland. Illustrated. . . . . 2 50	
HAMILTON (ALLAN McL., M. D.) Clinical Electro-Therapeutics, Medical and Surgical. A Hand-book for Physicians in the Treatment of Nervous and other Diseases. 8vo. . . . . Cloth, 2 00*	
HAMMOND (W. A.) A Treatise on Diseases of the Nervous System. By William A. Hammond, M. D., Surgeon-General U. S. Army (retired), Professor of Diseases of the Mind and Nervous System, in the Medical Department of the University of the City of New York, etc. . . . . (New edition in press.)	
—— A Treatise on Insanity. . . . . (In active preparation.)	
—— Clinical Lectures on Diseases of the Nervous System. Delivered at Bellevue Hospital Medical College. Edited by T. M. B. Cross, M. D. 8vo. . . . . Cloth, 3 50*	
HARVEY (A.) First Lines of Therapeutics. 12mo. . . . . Cloth, 1 50*	
HEART AND ITS FUNCTIONS. Health Primers. 16mo. . . . Cloth, 40	
HEALTH PRIMERS. Edited by J. Langdon Down, M. D., F. R. C. P.; Henry Power, M. B., F. R. C. S.; J. Mortimer-Granville, M. D.; John Tweedy, F. R. C. S. In square 16mo vols. . . . . Cloth, each, 40	
1. Exercise and Training.	
2. Alcohol: Its Use and Abuse.	
3. The House and its Surroundings.	
4. Premature Death: Its Promotion or Prevention.	
5. Personal Appearance in Health and Disease.	
6. Baths and Bathing.	
7. The Skin and its Troubles.	
8. The Heart and its Functions.	
HINTON'S Physiology for Practical Use. 12mo. . . . . Cloth, 2 25	
HOFFMANN-ULTZMANN. Introduction to an Investigation of Urine, with Special Reference to Diseases of the Urinary Apparatus. By M. B. Hoffmann, Professor in the University of Gratz, and R. Ultzmann, Tutor in the University of Vienna. Second enlarged and improved edition. 8vo. . . . . Cloth, 2 00*	

	PRICE
HOFFMANN (FREDERICK, Ph. D., Pharmacist in New York). Manual of Chemical Analysis, as applied to the Examination of Medicinal Chemicals. A Guide for the Determination of their Identity and Quality, and for the Detection of Impurities and Adul- terations. For the Use of Pharmacutists, Physicians, Druggists, and Manufacturing Chemists, and Students.....Cloth,	\$3 00*
HOSMER. The Every-day Doctor .....	Full Roan, 3 00
HOLLAND (Sir HENRY, Bart., M. D.) Recollections of Past Life. 12mo.... ..Cloth,	2 00
HOUSE AND ITS SURROUNDINGS. Health Primers. 16mo. Cloth,	40
HOWE (JOSEPH W.) Emergencies, and How to Treat Them. By Joseph W. Howe, M. D., Visiting Surgeon to Charity Hospital; Clin- ical Professor of Surgery in the Medical Department of the Univer- sity of New York, etc. 8vo.....Cloth,	2 50*
—— The Breath, and the Diseases which give it a Fetid Odor. With Directions for Treatment. 12mo.....Cloth,	1 00
HUNTER (JAMES B., M. D.) A Manual of Gynecological Operations. With Illustrations.... ..( <i>In preparation.</i> )	
HUXLEY (T. H., LL. D.) The Anatomy of Vertebrated Animals. 12mo. Illustrated.....Cloth,	2 50
—— The Anatomy of Invertebrated Animals. 12mo. Illustrated. Cloth,	2 50
HUXLEY AND YOUMANS'S Elements of Physiology and Hygiene. By T. Huxley and W. J. Youmans. 12mo.....	1 75
JOHNSTON'S Chemistry of Common Life. Illustrated. 12mo. Cloth,	2 00
KEYES. The Tonic Treatment of Syphilis, including Local Treatment of Lesions. By E. L. Keyes, Adjunct Professor of Surgery, and Professor of Dermatology, B. H. M. C., and Surgeon to Bellevue Hospital. 8vo.....Cloth,	1 00*
KINGSLEY (N. W., M. D.) A Treatise on Oral Deformities as a Branch of Mechanical Surgery. With over 350 Illustrations. 8vo. Cloth, \$5.00*; Sheep,	6 00*
LEGG (J. WICKHAM, M. D.) On the Bile, Jaundice, and Bilious Dis- eases. With Illustrations in Chromo-Lithography. 8vo. Cloth, \$6.00*; Sheep,	7 00*
LETTERMAN (J., M. D.) Medical Recollections of the Army of the Potomac. 8vo.... ..Cloth,	1 00
LEWES'S Physiology of Common Life. 2 vols., 12mo.....Cloth,	3 00
LINDSAY (W. L.) Mind in the Lower Animals. 2 vols., 8vo. Cloth,	4 00
LUSK (WILLIAM T., M. D.) The Science and Art of Midwifery. .....( <i>In preparation.</i> )	
MARKOE (T. M.) A Treatise on Diseases of the Bones. By Thomas M. Markoe, M. D., Professor of Surgery in the College of Physicians and Surgeons. With Illustrations. 8vo.....Cloth,	4 50*
MAUDSLEY (HENRY). Body and Mind: an Inquiry into their Con- nection and Mutual Influence, specially in reference to Mental Dis- orders. An enlarged and revised edition, to which are added Psychological Essays. By Henry Maudsley, M. D., London, Fellow of the Royal College of Physicians; Professor of Medical Jurispru- dence in University College, London, etc. 12mo.....Cloth,	1 50
—— Physiology of the Mind. Being the first part of a third edition, revised, enlarged, and in great part rewritten, of "The Physi- ology and Pathology of the Mind." 12mo.....Cloth,	2 00
—— Pathology of the Mind. Third edition. 12mo....Cloth,	2 00
—— Responsibility in Mental Disease. ( <i>International Scientific Series.</i> ) 12mo.....Cloth,	1 50

	PRICE
McSHERRY. Health and How to Promote it. . . . .	Cloth, \$1 25
MEYER (Dr. MORITZ). Electricity in its Relations to Practical Medicine. Translated from the third German edition, with numerous Notes and Additions, by William A. Hammond, M. D., Professor of Diseases of the Mind and Nervous System, in the Bellevue Hospital Medical College, etc. With numerous Illustrations. 8vo. . . . .	Cloth, 4 50*
NEFTEL (WM. B., M. D.) Galvano-Therapeutics. The Physiological and Therapeutical Action of the Galvanic Current upon the Acoustic, Optic, Sympathetic, and Pneumogastric Nerves. 12mo. . . . .	Cloth, 1 50*
NEUMANN (ISIDOR). Hand-Book of Skin Diseases. By Dr. Isidor Neumann. Translated by Lucius D. Bulkley, A. M., M. D. Illustrated by 66 Wood Engravings. 8vo. . . . .	Cloth, \$4.00*; Sheep, 5 00*
NEW YORK MEDICAL JOURNAL. Edited by Frank P. Foster, M. D. . . . .	Terms per annum, 4 00*
Specimen numbers sent by mail, on receipt of 25 cents.	
CLUB RATES: New York Medical Journal and Appletons' Journal (full price \$7.00). . . . .	6 25
Medical Journal and Popular Science Monthly, or North American Review (full price \$9.00). . . . .	8 00
NIEMEYER (Dr. FELIX VON). A Text-Book of Practical Medicine, with particular reference to Physiology and Pathological Anatomy. Containing all the author's Additions and Revisions in the eighth and last German edition. Translated from the German edition, by George H. Humphreys, M. D., and Charles E. Hackley, M. D. 2 vols., 8vo. . . . .	Cloth, \$9.00*; Sheep, 11 00*
NIGHTINGALE'S (FLORENCE) Notes on Nursing. 12mo. . . . .	Cloth, 75
PAGET. Clinical Lectures and Essays. By Sir James Paget, Bart., F. R. S., D. C. L., Oxon., LL. D., Cantab., etc. Edited by Howard Marsh, F. R. C. S., etc. 8vo. . . . .	Cloth, 5 00*
PEASLEE (E. R.) A Treatise on Ovarian Tumors; their Pathology, Diagnosis, and Treatment, with reference especially to Ovariectomy. By E. R. Peaslee, M. D., LL. D., Professor of Diseases of Women, in Dartmouth College; formerly Professor of Obstetrics and Diseases of Women, in the New York Medical College; Corresponding Member of the Obstetrical Society of Berlin, etc. In one large vol., 8vo. With Illustrations. . . . .	Cloth, \$5.00*; Sheep, 6 00*
PEREIRA'S (Dr.) Elements of Materia Medica and Therapeutics. Abridged and adapted for the Use of Medical and Pharmaceutical Practitioners and Students, and comprising all the Medicines of the British Pharmacopœia, with such others as are frequently ordered in Prescriptions, or required by the Physician. Edited by Robert Bentley and Theophilus Redwood. New edition. Royal 8vo.	Cloth, \$7.00*; Sheep, 8 00*
QUAIN. A Dictionary of Medicine. Edited by Richard Quain, M. D., F. R. S; assisted by numerous Eminent Writers. 8vo.	
RANNEY (AMBROSE L.) Applied Anatomy of the Nervous System, being a Study of this Portion of the Human Body from a Standpoint of its General Interest and Practical Utility, designed for Use as a Text-Book and as a Work of Reference. . . . .	(In press.)
RICHARDSON. Diseases of Modern Life. By Benjamin Ward Richardson, M. D., M. A., F. R. S. 12mo. . . . .	Cloth, 2 00
— A Ministry of Health. 12mo. . . . .	Cloth, 1 50
ROSCOE-SCHORLEMMER. Treatise on Chemistry.	
Vol. 1. Non-Metallic Elements. 8vo. . . . .	Cloth, 5 00
Vol. 2. Part I. Metals. 8vo. . . . .	Cloth, 3 00
Vol. 2. Part II. Metals. 8vo. . . . .	Cloth, 3 00
SAYRE (LEWIS A., M. D.) Practical Manual of the Treatment of Club-Foot. By Lewis A. Sayre, M. D., Professor of Orthopedic Surgery in the Bellevue Hospital Medical College; Surgeon to Bellevue Hospital, etc. New edition. 12mo. . . . .	Cloth, 1 25

	PRICE
SAYRE (LEWIS A., M. D.) Lectures on Orthopedic Surgery and Diseases of the Joints, delivered at Bellevue Hospital Medical College, during the Winter Session of 1874-1875, by Lewis A. Sayre, M. D.....Cloth, \$5.00*; Sheep,	\$6 00'
SCHROEDER (Dr. KARL). A Manual of Midwifery, including the Pathology of Pregnancy and the Puerperal State. By Dr. Karl Schroeder, Professor of Midwifery, and Director of the Lying-in Institution, in the University of Erlangen. Translated into English from the third German edition, by Charles H. Carter, B. A., M. D., B. S., London; Member of the Royal College of Physicians, London, etc. With 26 Engravings on Wood. 8vo...Cloth, \$3.50*; Sheep,	4 50*
SIMPSON (Sir JAMES Y.) Selected Works: Anæsthesia, Diseases of Women. 3 vols., 8vo. Per volume.....Cloth, \$3.00*; Sheep,	4 00*
SKIN (THE) AND ITS TROUBLES. Health Primers. 16mo..Cloth,	40
SMITH (EDWARD, M. D., LL. B., F. R. S.) Foods. ( <i>International Scientific Series</i> ).....	1 75
—— Health: a Hand-Book for Households and Schools. 12mo.Cloth,	1 00
STEINER. Compendium of Children's Diseases: a Hand-Book for Practitioners and Students. By Dr. Johannes Steiner, Professor of Diseases of Children in the University of Prague, etc. Translated from the second German edition, by Lamson Tait, F. R. C. S., etc. 8vo.....Cloth, \$3.50*; Sheep,	4 50*
STROUD (WILLIAM, M. D.) The Physical Cause of the Death of Christ. 12mo.....Cloth,	2 00
SWETT'S Diseases of the Chest. 8vo.....Cloth,	3 50*
TILT'S Hand-Book of Uterine Therapeutics. Second American edition, revised and amended. 8vo, 368 pages.....Cloth,	3 50*
VAN BUREN (W. H.) Lectures upon Diseases of the Rectum, and the Surgery of the Lower Bowel, delivered at Bellevue Hospital Medical College; by W. H. Van Buren, M. D., LL. D., Professor of the Principles and Practice of Surgery in the Bellevue Hospital Medical College; one of the Consulting Surgeons of the New York Hospital; of the Bellevue Hospital; Member of the New York Academy of Medicine; of the Pathological Society of New York, etc. <b>New edition, enlarged and rewritten.</b> 8vo.....Cloth,	3 00*
VAN BUREN AND KEYES. A Practical Treatise on the Surgical Diseases of the Genito-Urinary Organs, including Syphilis. Designed as a Manual for Students and Practitioners. With Engravings and Cases. By W. H. Van Buren, M. D., LL. D., and Edward L. Keyes, A. M., M. D., Professor of Dermatology in Bellevue Hospital Medical College; Surgeon to the Charity Hospital, Venereal Division; Consulting Dermatologist to the Bureau of Out-Door Relief, Bellevue Hospital, etc. 8vo.	
	Cloth, \$5.00*; Sheep, 6 00*
VOGEL (A.) A Practical Treatise on the Diseases of Children. By Alfred Vogel, M. D., Professor of Clinical Medicine in the University of Dorpat, Russia. Translated and edited by H. Raphael, M. D., late House Surgeon to Bellevue Hospital; Attending Physician to the Eastern Dispensary for the Diseases of Children, etc. From the fourth German edition. Illustrated by six Lithographic Plates. 8vo.	
	Cloth, \$4.50*; Sheep, 5 50*
WAGNER (RUDOLF). Hand-book of Chemical Technology. Translated and edited from the eighth German edition, with extensive Additions, by William Crookes, F. R. S. With 336 Illustrations. 8vo, 761 pages ... ..Cloth,	5 00
WALTON (GEORGE E., M. D.) Mineral Springs of the United States and Canadas. Containing the latest Analyses, with full Description of Localities, Routes, etc. 12mo.....Cloth,	2 00
WELLS (Dr. T. SPENCER). Diseases of the Ovaries. 8vo.....Cloth,	4 50
WYLIE (WILLIAM G.) Hospitals.... ..	2 50*

# APPLETONS' PERIODICALS.

---

## *APPLETONS' JOURNAL :*

A Magazine of General Literature. Subscription, \$3.00 per annum; single copy, 25 cents. The volumes begin January and July of each year.

## *THE POPULAR SCIENCE MONTHLY:*

Conducted by E. L. and W. J. YOUNG. Containing instructive and interesting articles and abstracts of articles, original, selected, and illustrated, from the pens of the leading scientific men of different countries. Subscription, to begin at any time, \$5.00 per annum; single copy, 50 cents. The volumes begin May and November of each year.

## *THE NORTH AMERICAN REVIEW :*

Published Monthly. Containing articles of general public interest, it is a forum for their full and free discussion. It is cosmopolitan, and, true to its ancient motto, it is the organ of no sect, or party, or school. Subscription, \$5.00 per annum; single copy, 50 cents.

## *THE NEW YORK MEDICAL JOURNAL :*

Edited by FRANK P. FOSTER, M. D. Subscription, \$4.00 per annum; single copy, 40 cents.

---

## CLUB RATES

POSTAGE PAID.

	Prices.	
	Regular.	Club.
Appletons' Journal and Science Monthly.....	\$ 8.00	\$ 7.00
And North American Review.....	13.00	11.50
Science Monthly and New York Medical Journal.....	9.00	8.00
And North American Review .....	14.00	12.50
Appletons' Journal and New York Medical Journal .....	7.00	6.25
And North American Review .....	12.00	10.50
Science Monthly and North American Review .....	10.00	9.00
Appletons' Journal and North American Review .....	8.00	7.00
New York Medical Journal and North American Review.....	9.00	8.00

---

*D. APPLETON & CO., Publishers, New York.*

## TO THE MEDICAL PROFESSION

---

WE beg to call your attention to the merits of the **NEW YORK MEDICAL JOURNAL**. In doing so, we can say with confidence that this journal occupies a higher place in medical literature than any other monthly publication in this country, and that henceforth no effort will be spared to enhance its value, and render it indispensable to every practitioner who desires to keep up with the times. Trusting you will favor us with your support,

We are, yours truly,

**D. APPLETON & CO.**

---

*The foremost American Monthly.*

---

THE

## NEW YORK MEDICAL JOURNAL,

Edited by **FRANK P. FOSTER, M. D.,**

Physician for Diseases of Women to the Out-Patient Department of the New York Hospital;  
Fellow of the New York Obstetrical Society, etc., etc.

The **JOURNAL** contains 112 octavo pages in each number, consisting of

**ORIGINAL COMMUNICATIONS**, for the most part practical in character.

**LECTURES**, Didactic and Clinical, by College Professors and Hospital Physicians and Surgeons.

**EDITORIALS.**

**REVIEWS AND LITERARY NOTES.**

**CLINICAL REPORTS** of Hospital and Dispensary Practice.

**PROCEEDINGS OF SOCIETIES**, including regular reports of the New York Academy of Medicine, the Medical Society of the County of New York, the New York Pathological Society, and the New York Obstetrical Society; official reports (published in this Journal only) of the New York Therapeutical Society, the New York Society of German Physicians, and the New York Clinical Society; reports of other societies from time to time.

**REPORTS ON THE PROGRESS OF MEDICINE**: separate reports *quarterly* on General Medicine; Surgery; Obstetrics and Gynæcology; Diseases of Children; Materia Medica, Therapeutics, and Toxicology; Diseases of the Eye and Ear; Venereal and Genito-Urinary Diseases; Orthopædic Surgery; and Dermatology—*semi-annually* on Anatomy and Physiology; and Psychological Medicine.

**LETTERS TO THE EDITOR. MISCELLANY.**

---

A new volume of the **NEW YORK MEDICAL JOURNAL** begins with the numbers for January and July of each year. Trial subscriptions, three months, \$1.00; six months, \$2.00.

**Terms, \$4.00 per Annum, Postage prepaid by the Publishers.**

A General Index to the **NEW YORK MEDICAL JOURNAL**, from its first issue to June, 1876—including twenty-three volumes—now ready. Price, 75 cents.

**D. APPLETON & CO., Publishers,**

1, 3, & 5 BOND STREET, NEW YORK.













